



City of Sebastopol Planning Commission Staff Report

Meeting Date: August 15, 2023
Agenda Item: 6A
To: Planning Commission
From: Design Guideline Subcommittee
Kari Svanstrom, Planning Director
John Jay, Associate Planner
Subject: Objective Design Standards Recommendation
Recommendation: Review Guidelines, Adopt Resolution Recommending adoption to City Council

Introduction/Background:

The State of California has adopted legislation in recent years that impact the ability of a local jurisdiction to implement their adopted discretionary Design Guidelines and requirements for certain residential projects, including certain multi-family residential development (vis SB35) and, most recently, SB9 for single family residential zones related to additional units on single family parcels through either lot subdivisions (“lot splits”) and developing homes on a newly subdivided lot or through the conversion of existing single-family homes into multiple units.

The City Council created a Design Guideline Subcommittee in 2019 to address updates to the City’s Design Guidelines and in response to these state laws. The committee includes Paul Fritz from the Planning Commission, Design Review Board members Lars Langberg and Christine Level, and, until his retirement from Council, Patrick Slayter (the Council decided to let this committee continue with out council representation due to the technical nature of the committee). This committee has already developed Standard Conditions of Approval, which can be utilized for both standard city projects, and streamlined (SB35) projects.

Discussion:

Staff began working with Opticos on this project in September 2022, and the ODS/SB9 project kicked off with the Design Guideline Subcommittee in November 2022 and the Subcommittee has met several times since then to develop the draft Objective Design Guidelines presented here for review by the Planning Commission. The Design Review Board (DRB) began their review of the Guidelines on July 25, 2023, and continued their review to their August meeting (after this Planning Commission mtg).

The Design Guideline Subcommittee is working with Planning staff and Opticos, the City's consultant for this project, to develop Objective Design Standards. Once adopted, the Objective Design Standards (ODS) can be utilized for SB35 applications which are exempt from the normal 'discretionary' design review process.

It is anticipated that these will also provide more certainty for both developers and the community in terms of the intent of the existing discretionary design guidelines. However, it is important to note that this will not replace the existing Design Guidelines, which would still be administered by the Design Review Board (DRB). In the DRB's review and discussion of these final draft guidelines, they noted that these guidelines should be used strictly for SB35required projects, as there are limitations in design flexibility and ingenuity inherent in the guidelines given the prescriptive nature required for Objective Design Guidelines where the City and decision-makers have no description. Therefore, these should not be applied to discretionary design review projects.

General Plan Consistency:

This action supports the following City Council Goals:

Goal 4.1 - Create a Safe, Healthy and Attractive Environment for Residents and Visitors

Goal 7 - Provide and Develop a Plan for the Future for the City of Sebastopol with the Implementation of the new General Plan

7.2.1 Incorporate the Small Town Character values into the City's land use policies

7.2.2 Review, evaluate and update the Design Review Guidelines

Goal 9 - Enhance housing opportunities in Sebastopol and, when possible, provide assistance to housing projects.

9.1.3 Engage with community on housing issues and suggested review of City policies to facilitate a positive jobs/housing balance.

The following General Plan Actions:

Goal CD 1: Preserve and Enhance Sebastopol's Unique Character, Design, and Sense of Place as a Small, Compact Town

Policy CD 1-1: Ensure that new development is constructed in a manner consistent with the City's Design Guidelines, and any design guidelines for specific areas or types of development.

Policy CD 1-2: Ensure that new residential and commercial development is sensitive to the surrounding architecture, topography, landscaping, character, scale, and ambiance of the surrounding neighborhood.

Policy CD 1-3: Discourage repetitive designs in residential and commercial areas, while establishing a cohesive visual relationship between structures and their surroundings.

Policy CD 1-6: Maintain and enforce Zoning Ordinance provisions and design guidelines that prohibit auto-centric strip development.

Policy CD 1-12: Require the design of new residential development to be consistent with the City's design guidelines, to ensure that new development contributes to the small town character of Sebastopol.

Financial Impact:

The project is being supported by a state planning grant (SB2 grant) funding, and the City's General Plan Update fund.

Public Comment:

No public comments have been received as of the writing of this staff report.

Recommendation:

Staff recommends the Commission review the draft and provide any recommended modifications. Staff further recommends that the Commission adopt the attached resolution recommending the City Council adopt the Objective Design Standards.

Attachments:

Draft Resolution

Objective Design Standards Final Draft

RESOLUTION NO. 23-xx

RESOLUTION OF THE PLANNING COMMISSION OF THE CITY OF SEBASTOPOL
RECOMMENDING THE CITY COUNCIL ADOPT THE OBJECTIVE DESIGN STANDARDS

WHEREAS, the City of Sebastopol completed a comprehensive General Plan update with adoption of a new General Plan on November 15, 2016; and

WHEREAS, pursuant to the California Environmental Quality Act (CEQA, codified at Public Resources Code § 21000 et seq.) and the State CEQA Guidelines (14 CCR, § 15000 et seq.), on November 15, 2016, the City Council certified and adopted an Environmental Impact Report (EIR) for the Sebastopol General Plan (the “Project”; State Clearinghouse No. 2016032001); and

WHEREAS, the project is consistent with the General Plan, in that it conforms to the following actions:

- **Goal CD 1:** Preserve and Enhance Sebastopol’s Unique Character, Design, and Sense of Place as a Small, Compact Town
- **Policy CD 1-1:** Ensure that new development is constructed in a manner consistent with the City’s Design Guidelines, and any design guidelines for specific areas or types of development.
- **Policy CD 1-2:** Ensure that new residential and commercial development is sensitive to the surrounding architecture, topography, landscaping, character, scale, and ambiance of the surrounding neighborhood.
- **Policy CD 1-3:** Discourage repetitive designs in residential and commercial areas, while establishing a cohesive visual relationship between structures and their surroundings.
- **Policy CD 1-6:** Maintain and enforce Zoning Ordinance provisions and design guidelines that prohibit auto-centric strip development.
- **Policy CD 1-12:** Require the design of new residential development to be consistent with the City’s design guidelines, to ensure that new development contributes to the small town character of Sebastopol. And,

WHEREAS, the project is consistent with the following City Council Goals:

- **Goal 4.1** - Create a Safe, Healthy and Attractive Environment for Residents and Visitors
- **Goal 7** - Provide and Develop a Plan for the Future for the City of Sebastopol with the Implementation of the new General Plan
- **7.2.1** Incorporate the Small Town Character values into the City’s land use policies
- **7.2.2** Review, evaluate and update the Design Review Guidelines

- **Goal 9** - Enhance housing opportunities in Sebastopol and, when possible, provide assistance to housing projects.
- **9.1.3** Engage with community on housing issues and suggested review of City policies to facilitate a positive jobs/housing balance. And,

WHEREAS, in 2019 the City Council of the City of Sebastopol created the Design Review Subcommittee which includes members from the Planning Commission, Design Review Board, and City Council to review and develop Objective Design Standards for the City; and,

WHEREAS, in September 2022 the Planning Department began working with Opticos to develop the Objective Design Standards (ODS) and Senate Bill 9 (SB9) standards; and,

WHEREAS, the Design Review Subcommittee met throughout 2022 and 2023 with Planning staff to develop the Objective Design Standards; and,

WHEREAS, on February 28, 2023 the Planning Department provided a staff report and presentation to the Planning Commission update on progress on the Objective Design Standards; and,

WHEREAS, on May 23, 2023 the Planning Department provided a staff report and presentation to the Design Review Board to update on progress on the Objective Design Standards; and,

WHEREAS, on August 15, 2023 the Planning Department provided a staff report and presentation to the Planning Commission to update on progress of the Objective Design Standards; and,

NOW, THEREFORE, THE PLANNING COMMISSION DOES HEREBY ADOPT THIS RESOLUTION finding that the Objective Design Standards are consistent with the City's General Plan goals related to community design and recommending the City Council adopt the Objective Design Standards.

Approved on August 15, 2023 by the following vote:

AYES:

NOES:

ABSTAIN:

ABSENT:

Certified: _____

Kari Svanstrom, Planning Director

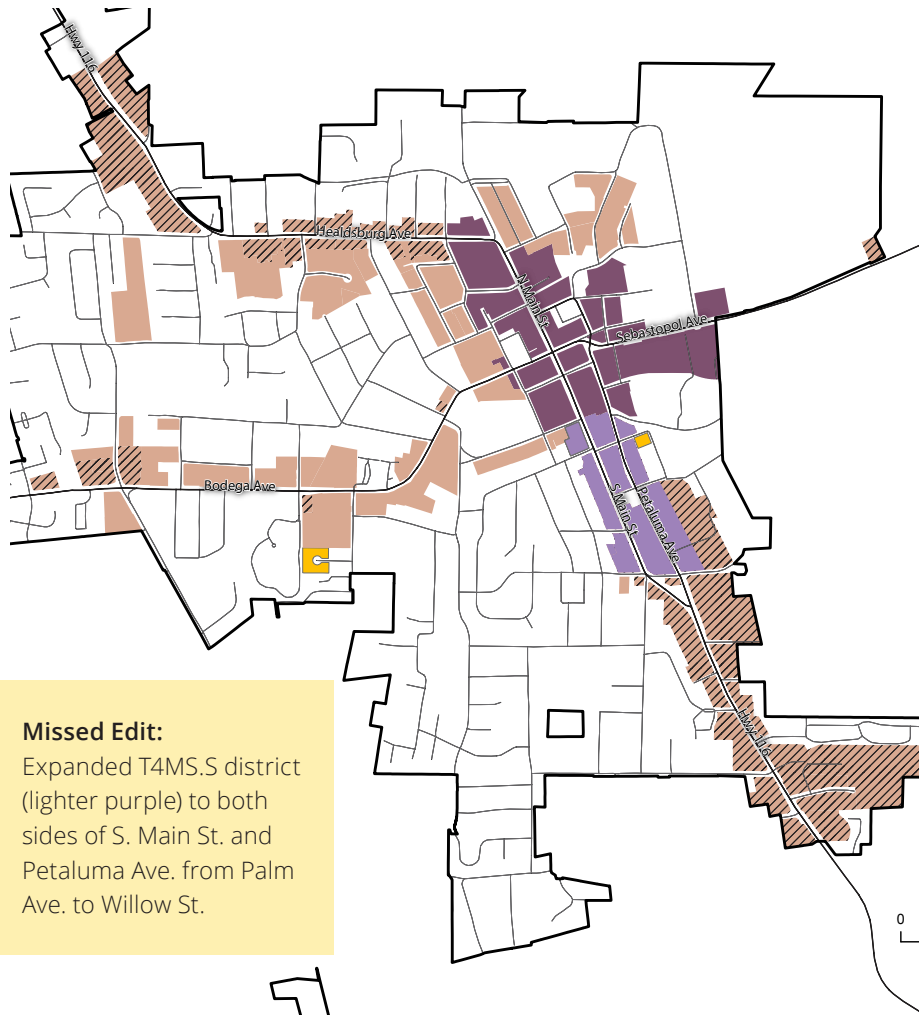

Missed Edit:
 Expanded T4MS.S district
 (lighter purple) to both
 sides of S. Main St. and
 Petaluma Ave. from Palm
 Ave. to Willow St.



Article 2: Objective Design Standards

Final Draft
 Prepared for: City of Sebastopol
 July 17, 2023
 August 03, 2023



Review Note:

This draft of Article 2: Objective Design Standards, dated August 03, 2023, addresses missed edits raised at the July 25, 2023 Design Review Board meeting. The missed edits are identified by redline strikethrough for content to be removed or a word to be changed. Yellow sticky notes are used to identify content to be added to the page. This has been done to not affect the page layout or number of pages in the July 17, 2023 draft. These and other updates resulting from the review and final direction for this document will be made to the Adoption Hearing Draft after the Design Review Board and Planning Commission final review of this draft.

This page intentionally left blank

Table of Contents

Preamble		1
P-1A	Creating a Place-Based Foundation for Objective Design Standards	1
P-1B	Guiding Principles	1
P-1C	Classification of Different Context Types in Sebastopol	2
P-1D	Summary of the Form-Based Districts in Sebastopol	4
P-1E	A Place-Based Approach for Sebastopol	4
P-1F	The Transect	10
Chapter 1: Introduction		11
1.010	Purpose	11
1.020	Applicability	11
1.030	Relationship to the Sebastopol General Plan	15
1.040	Relationship to City of Sebastopol Municipal Code	15
Chapter 2: Establishment of Districts		17
2.010	Purpose	17
2.020	Districts Established	17
2.030	Sub-Districts	18
2.040	Form-Based District Map	18
Chapter 3: Districts		19
3.010	Purpose	19
3.020	General Requirements	19
3.030	T3 Neighborhood Edge (T3NE)	29
3.040	T4 Neighborhood.Small (T4N.S)	33
3.050	T4 Main Street.Small (T4MS.S)	37
3.060	T4 Main Street.Medium (T4MS.M)	41
3.070	Adjacency Requirements	45

Chapter 4:	General to Design Sites	47
4.010	Purpose	47
4.020	Screening	48
4.030	Landscaping and Lighting	50
4.040	Parking and Loading	52
4.050	Slope Standards	58
4.060	Public Frontage Standards	64
Chapter 5:	Specific to Building Types	67
5.010	Purpose	67
5.020	Building Types	67
5.030	Overview of Building Types	70
5.040	House	72
5.050	Duplex Side-by-Side	74
5.060	Cottage Court	76
5.070	Multiplex Small	78
5.080	Neighborhood Townhouse	80
5.090	Side Court	82
5.100	Neighborhood Courtyard	84
5.110	Pocket Neighborhood	87
5.120	Multiplex Medium	90
5.130	Core Townhouse	92
5.140	Core Courtyard	94
5.150	Main Street Building	96
5.160	Massing Compositions	98

Chapter 6:	Specific to Private Frontage Types	105
6.010	Purpose	105
6.020	General Requirements for Private Frontage Types	105
6.030	Allowed Private Frontage Types	106
6.040	Porch Projecting	108
6.050	Porch Engaged	110
6.060	Dooryard	112
6.070	Stoop	114
6.080	Forecourt	116
6.090	Maker Shopfront	118
6.100	Shopfront	120
6.110	Terrace	122
6.120	Gallery	124
Chapter 7:	Specific to Architectural Design	127
7.010	Purpose	127
7.020	Applicability	127
7.030	Architectural Design Standards	127
7.040	Architectural Variety Standards	129
7.050	Building Volume and Façade Composition Standards	129
7.060	Bird Safety	134
7.070	Durability	134
7.080	Privacy Standards	135
7.090	Standards for Architectural Elements	137

Chapter 8:	Specific to Signage Types	151
8.010	Purpose	151
8.020	Sign Types	152
8.030	Overview of Sign Types	152
8.040	Yard/Porch Sign	154
8.050	Projecting Sign	156
8.060	Awning/Canopy Sign	158
8.070	Wall Sign	160
8.080	Painted Wall Sign	162
8.090	Window Sign	164
8.100	Sidewalk Sign	166
8.110	Directory Sign	168
Chapter 9:	Specific to Large Sites	171
9.010	Purpose	171
9.020	Walkable Neighborhood Plan	172
9.030	General to Open Space	177
9.040	General to Thoroughfares	183
Chapter 10:	Administration	189
10.010	Purpose	189
10.020	Procedures	189
10.030	Adjustments to Standards	203
Chapter 11:	Definitions	209
11.010	Purpose	209
11.020	Definitions	209
11.030	Measurement Methods	236

This page intentionally left blank

Quick Code Guide for Developments Less Than Three Acres

The following graphic is intended as a summary guide. Please refer to the procedures for applications eligible for streamlined review consistent with State Law [Section 10.020 (Procedures)] for all necessary information.

1 Determine your Maximum Zoning Envelope ¹		
Identify your district , see Chapter 3 (Districts)	a. Select your building type(s)	Subsection 3 of the district
	b. Comply with building placement standards	Subsection 5 of the district
	c. Comply with building form and height standards	Subsection 4 of the district
	d. Select from allowed uses	See underlying zoning allowed uses in Title 17 (Zoning)
	e. Comply with parking standards	Subsection 7 of the district
	f. Select your private frontage type	Subsection 8 of the district
Identify your building type standards , see Chapter 5 (Specific to Building Types)	a. Select your detailed massing type	Subsection 3 of the building type
	b. Comply with the standards	Subsections 1, 2, 4-7 of the building type

¹ Developments that propose multiple design sites shall apply this process for each design site.

2 Connect Ground Floor to Adjacent Streetscape		
Apply your private frontage type(s) , see Chapter 6 (Specific to Private Frontage Types)	Based on your selected private frontage type(s), comply with the standards	Subsections 1-4 of the private frontage type

3 Design your Building		
Identify your architectural standards , see Chapter 7 (Specific to Architectural Design)	Based on your selected detailed massing type, comply with the standards	Sections 7.030 to 7.090

Quick Code Guide for Developments Less Than Three Acres (Continued)

4 **Apply Signage (If Allowed)**

Identify your signage standards , see Chapter 8 (Specific to Signage Types)	Select your signage type	Subsections 1-4 of the signage type
--	--------------------------	-------------------------------------

5 **Proceed to Approval Process**

If adjustments are proposed , see Section 10.030 (Adjustments to Standards)	Meet the required findings to be eligible for the adjustment to the standard(s)	Section 10.030 (Adjustments to Standards)
Identify your approval procedure , see Chapter 10 (Administration)	Comply with the procedure standards	Section 10.020 (Procedures)

Quick Code Guide for Developments Over Three Acres

The following graphic is intended as a summary guide. Please refer to the procedures for applications eligible for streamlined review consistent with State Law [Section 10.020 (Procedures)] for all necessary information.

1 Design your Walkable Neighborhood Plan (WNP)		
Prepare WNP	Comply with the standards	Section 9.020 (Walkable Neighborhood Plan)
2 Determine your Maximum Zoning Envelope ¹		
Identify your district(s) , see Chapter 3 (Districts)	For each WNP:	Subsection 3 of the district
	a. Select your building type(s)	
	b. Comply with building placement standards	Subsection 5 of the district
	c. Comply with building form and height standards	Subsection 4 of the district
	d. Select from allowed uses	See underlying zoning allowed uses in Title 17 (Zoning)
	e. Comply with parking standards	Subsection 7 of the district
Identify your building type standards , see Chapter 5 (Specific to Building Types)	f. Select your private frontage type for each building type	Subsection 8 of the district
	a. Select your detailed massing type for each building type	Subsections 3 and 7 of the building type
	b. Comply with the standards	Subsections 1, 2, 4-7 of the building type
¹ This process shall be applied to each design site.		
3 Connect Ground Floor of each Building Type to Adjacent Streetscape		
Apply your private frontage types to each building type , see Chapter 6 (Specific to Private Frontage Types)	Based on your selected building types, comply with the standards	Subsections 1-4 of the private frontage type

Quick Code Guide for Developments Over Three Acres (Continued)

4 Design your Buildings		
Identify your architectural standards , see Chapter 7 (Specific to Architectural Design)	Select your architectural style standards for each building type	Sections 7.030 to 7.090
5 Apply Signage (If Allowed)		
Identify your signage standards , see Chapter 8 (Specific to Signage Types)	Select your signage types and apply to the relevant building types	Subsections 1-4 of the signage type
6 Proceed to Approval Process		
If adjustments are proposed , see Section 10.030 (Adjustments to Standards)	Meet the required findings to be eligible for the adjustment to the standard(s)	Section 10.030 (Adjustments to Standards)
Identify your approval procedure , see Chapter 10 (Administration)	Comply with the procedure standards	Section 10.020 (Procedures)

This page intentionally left blank

Preamble

Sections:

P-1A	Creating a Place-Based Foundation for Objective Design Standards
P-1B	Guiding Principles
P-1C	Classification of Different Context Types in Sebastopol
P-1D	Summary of the Form-Based Districts in Sebastopol
P-1E	A Place-Based Approach for Sebastopol
P-1F	The Transect

P-1A Creating a Place-Based Foundation for Objective Design Standards

This Article 2, "Objective Design Standards", shall hereafter be referred to as the "ODS". The ODS implements Sebastopol's General Plan vision through the application of districts and standards that reflect a context-specific approach based upon Sebastopol's distinct walkable development patterns. These patterns are described as walkable because of their interconnected streets and blocks; variety of housing choices; and proximity to services, shopping and/or transit. The ODS addresses the walkable development patterns, existing or intended, through standards consistent with Sebastopol's General Plan.

P-1B Guiding Principles

The ODS is guided by the following principles in implementing the Sebastopol General Plan:

1. Across Sebastopol, the ODS:
 - A. Provides clear and effective development standards that allow for streamlined review processes and the predictable production of housing;
 - B. Supports a diversity of housing choices appropriate to their location;
 - C. Ensures appropriately-scaled infill development;
 - D. Reinforces and enhances community design and character in support of the community's vision with: a variety of neighborhoods; main street areas as the cultural and commercial heart of the community; and neighborhoods with centers along pleasant and convenient corridors that interconnect the City;
 - E. Removes barriers to revitalization and reinvestment through clear, objective, and context-sensitive standards;
 - F. Ensures that each building plays a role in creating a better whole, not just a good building; and
 - G. Promotes development patterns that support safe, effective, and multi-modal transportation options for all users and help reduce greenhouse gas emissions.

2. Within centers, the ODS:
 - A. Reinforces the main street as a cultural and commercial destination accommodating appropriately-scaled infill housing, mixed-use, and cultural development compatible with existing historic buildings; and
 - B. Facilitates transitions from single-use areas to mixed-use employment centers that are compatible with adjacent residential neighborhoods and public access.
3. Within residential neighborhoods, the ODS:
 - A. Protects the character of established neighborhoods and builds upon and reinforces the unique physical characteristics of the City's walkable neighborhoods;
 - B. Supports new walkable neighborhood patterns through new networks of well-designed multi-modal streets that are safe for pedestrians and cyclists; and
 - C. Promotes neighborhoods with quality housing and diverse, context-sensitive housing choices.
4. Along corridors within, the ODS:
 - A. Promotes a variety of housing choices;
 - B. Promotes small local businesses as an important part of the City's economy;
 - C. Promotes incremental infill and revitalization;
 - D. Reinforces neighborhood main streets as centers to continue as vibrant social and commercial focal points, with services and amenities for the surrounding neighborhoods located within a safe, comfortable walking distance of homes;
 - E. Balances pedestrian comfort and place-making with traffic efficiency; and
 - F. Promotes and accommodates high-quality community design.

P-1C Classification of Different Context Types in Sebastopol

Sebastopol is characterized by different context types that reflect its pre- and post-World War II development patterns. Historic districts and neighborhoods developed prior to WWII tend to be more pedestrian-oriented, with smaller blocks, consistent sidewalks, more integrated development patterns with services, shopping and/or transit within short walking distance. Newer areas of the City, by comparison, tend to be more auto-oriented, with larger blocks and less amenities within short walking distance.

The ODS applies a context-sensitive approach to the City that is based upon the classification of three broad context types: Natural, Walkable, and Auto-Oriented Suburban. Each needs to be regulated differently to effectively reinforce the intended context. Figure P-1C-1 (Context Type Descriptions) provides full descriptions of each context type.

Within the Walkable and Auto-Oriented Suburban contexts, the ODS further articulates context through three types of areas across the City: areas at or near the Downtown, neighborhoods, and areas at the edge of the community. In order to make as direct a connection as possible between the context-sensitive approach and the standards, this physical structure is carried through into the names of the form-based districts in this ODS.

Figure P-1C-1: Context Type Descriptions

Natural Context

The Natural Context Type consists of land not intended for development. In these areas, nature dominates a person's experience, but may include an occasional recreation-oriented or utility building or other man-made feature. The use of cars occurs, but does not dominate the physical character.

These areas are implemented through conventional, use-based zones.



Auto-Oriented Suburban Context

The Auto-Oriented Suburban Context Type consists of areas developed mainly after the 1950's. This type of development is driven by the priority to accommodate the automobile. Characteristic of this context type, land uses are segregated and often buffered, leaving large distances between them contributing to the need for the automobile for day-to-day functions. Walking and cycling occur in these areas, but generally for recreational rather than destination purposes due to low connectivity and few amenities within short walking distance.

Examples of these areas are commercial big box retail, strip mall centers, single-unit residential subdivisions, and industrial areas.

These areas are implemented through conventional, use-based zones, or in areas where walkable development is desired, through form-based districts.



Walkable Context

The Walkable Context Type consists of areas where a person can walk, bike or ride transit to work to fulfill most shopping and recreation needs. These areas allow for but do not require the use of a vehicle to accommodate most daily needs.

These areas, primarily developed prior to the 1940's, were developed in a pattern where a person can live with limited reliance on the automobile. Today, these areas are still conducive to destination walking and cycling. These areas are supported through a network of interconnected, tree-lined streets, a diversity of housing choices, and a mix of appropriate commercial and residential uses in a compact form. These areas also support public transit due to their compact nature.

These areas are implemented through form-based districts.



P-1D Summary of the Form-Based Districts in Sebastopol

The ODS implements Sebastopol's General Plan through form-based districts based on the transect. The transect applies to Natural, Rural, and Walkable Contexts as illustrated in Table P-1E-B (Summary Table of Transects for Natural, Rural, and Walkable Contexts in Sebastopol). These contexts are implemented through the form-based districts identified in Table P-1F-A (Sebastopol Transect). See Chapter 3 (Districts) for details of each district.

P-1E A Place-Based Approach for Sebastopol

Through this ODS, form-based zoning is applied to Walkable Contexts, as well as to Auto-Oriented Suburban Contexts. The ODS will generate buildings that are scaled to the pedestrian and to existing and future neighboring buildings, and are placed to shape a public realm for pedestrians. While the ODS is intended to generate pedestrian-oriented, walkable development, the prevailing pattern in auto-oriented areas will continue to be a mix of pedestrian-oriented and auto-oriented development unless policy direction for those areas changes to only allow pedestrian-oriented development.

1. What is a Form-Based Code?

Form-Based Coding (FBC) represents a paradigm shift in the way that the built environment is regulated. The formal short definition of a FBC is as follows:

Form-Based Codes foster predictable built results and a high-quality public realm by using physical form (rather than separation of uses) as the organizing principle for the code. These codes are adopted into city or county law as regulations, not mere guidelines. Form-Based Codes are an alternative to conventional zoning.

-Form-Based Codes Institute

Unlike conventional, use-based codes, FBCs utilize the intended form and character, rather than use as the organizing framework of the code. This ODS is informed by the three physical context types described in Section P-1C (Classification of Different Context Types in Sebastopol) to implement the key characteristics that comprise the physical character of different areas (place types) documented across the community. Further, FBCs regulate a series of important elements not just to create a good individual building, but a high-quality place. The terminology in FBCs reflects the intended physical form and hierarchy of different places. For example, instead of a district being labeled "commercial" or "mixed use," it might be called "main street." The term "main street" ties back to the intended physical form or place, which includes a mix of uses, civic spaces, streets, frontages, and building types that create vibrant walkable urbanism.

It is also important to note that while FBCs primarily regulate the intended physical form, they regulate use secondarily. FBCs allow a range of uses that are carefully chosen to maximize compatibility between uses and the intended physical form of the district. The use-tables in a FBC are simplified and categorized by use-type, and clearly defined, to allow a greater degree of administrative decision-making related to particular uses.

2. The Natural-to-Urban Transect: The Framework for the Form-Based Code

Most FBCs use an organizing principle called the Natural-to-Urban Transect, see Figure P-1E-1. This enables a customized framework of districts for a community that are based on intended physical character.

The transect establishes a hierarchy of physical environments or transects from the most natural to the most urban. The designation of each transect along this hierarchy is determined first by the character and form, intensity of development, and type of place, and secondly by the mix of uses within the area. This hierarchy of physical environments becomes the framework for the entire FBC, replacing use as the organizing principle as in conventional, use-based zoning. Each transect is used to reinforce existing or create new walkable environments.

The Natural-to-Urban Transect is a means for considering and organizing the human habitat in a continuum of intensity that ranges from the most natural condition to the most urban. It provides a standardized method for differentiating between the intentions for urban form in various areas using gradual transitions rather than harsh distinctions. Each transect is primarily classified by the physical intensity of the built form, the relationship between nature and the built environment, and the complexity of uses within the transect.

~ Form-Based Codes Institute

Figure P-1E-1

A Natural Transect diagram illustrates a continuum of Natural Context Types from the ocean shore inland from left to right. Image courtesy of DPZ.

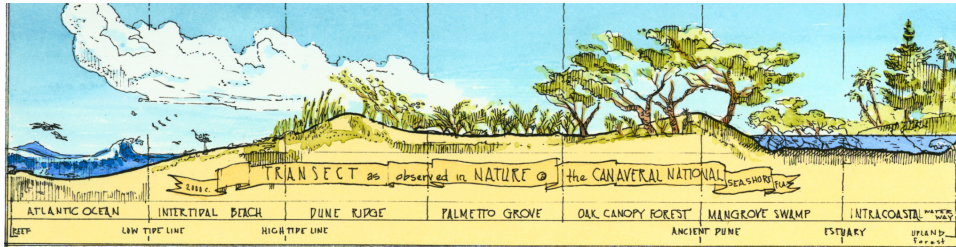

The Natural-to-Urban Transect diagram illustrates a continuum of context types from the most natural to the most urban from left to right. Image courtesy of DPZ.

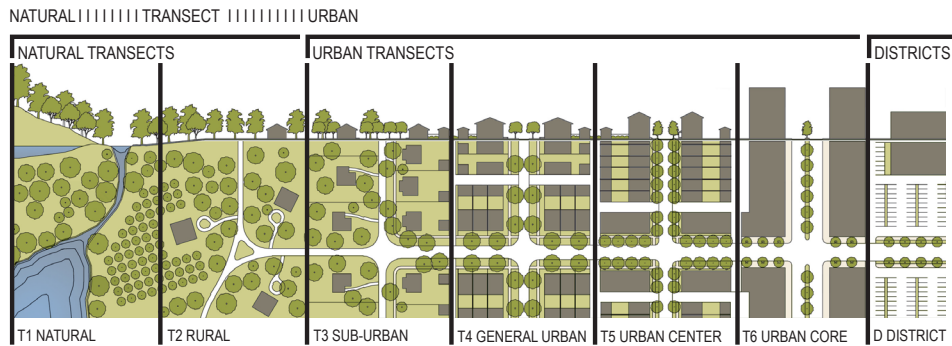

The model transect for American communities is divided into six individual transects and a Special District as shown in Table A (Model Transect for American Communities). Each transect is given a number. Higher numbers designate progressively more urban districts, and lower numbers designate less urban and natural districts. Sebastopol's form-based districts are customized based on this framework.

Table P-1E-A: Model Transect for American Communities	
Transect	Description
T1 - Natural	Lands approximating or reverting to a wilderness condition, including lands unsuitable for settlement due to topography, hydrology or vegetation
T2 - Rural	Sparsely settled lands in open or cultivated state, including woodland, agricultural land, and grassland
T3 - Walkable Neighborhood	Primarily residential with mix of lower intensity building types
T4 - General Urban or Walkable Neighborhood	Primarily residential with mix of moderate intensity building types and some lower intensity centers
T5 - Downtown Center	Higher intensity neighborhoods and higher intensity downtown centers - Not Applicable
T6 - Downtown Core	Regional-serving downtown - Not Applicable
D - District	Designation for areas with specialized purposes (e.g., heavy industrial, transportation, harbors, airports or university districts, among other possibilities)

This page intentionally left blank

Table P-1E-B: Summary Table of Transects for Natural, Rural, and Walkable Contexts in Sebastopol

◀ Less Urban











Natural	Rural	Walkable Contexts
T1	T2	T3 Walkable Neighborhood
 <p>Source: Google Images</p>	 <p>Source: Google Images</p>	 <p>Source: Google Images</p>
		
		
		

Table P-1E-B: Summary Table of Transects for Natural and Walkable Contexts in Sebastopol (Continued)

More Urban 

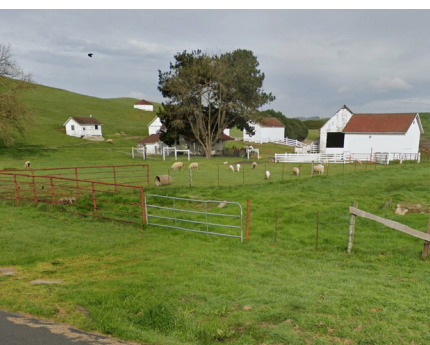
Walkable Contexts

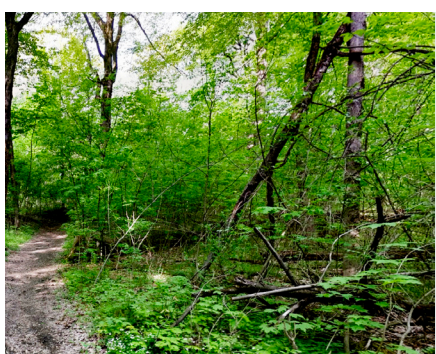
T4 Walkable Neighborhood

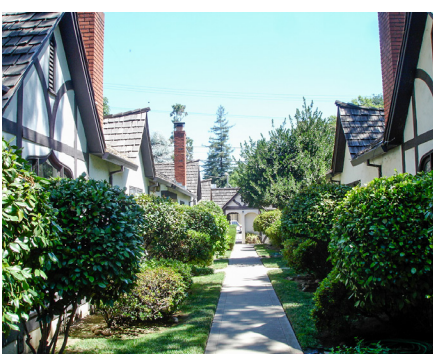
T5 Downtown Center

T6 Downtown Core

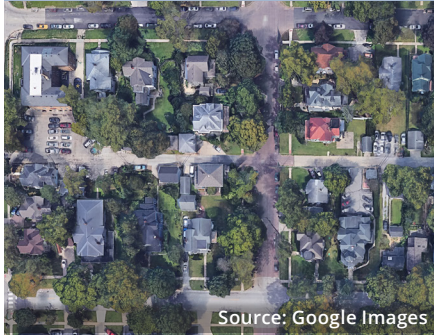

Not Applicable

Not Applicable



P-1F The Transect

Table P-1F-A (Sebastopol Transect) identifies the transects and the form-based districts that implement each transect. Sebastopol's transect includes four of the six individual transects. The form-based districts needed to implement Sebastopol's transect are identified in bold text.

Table P-1F-A: Sebastopol Transect					
T1	T2	T3	T4	T5	T6
Natural	Rural	Walkable Neighborhood	Walkable Neighborhood	Downtown Center	Downtown Core

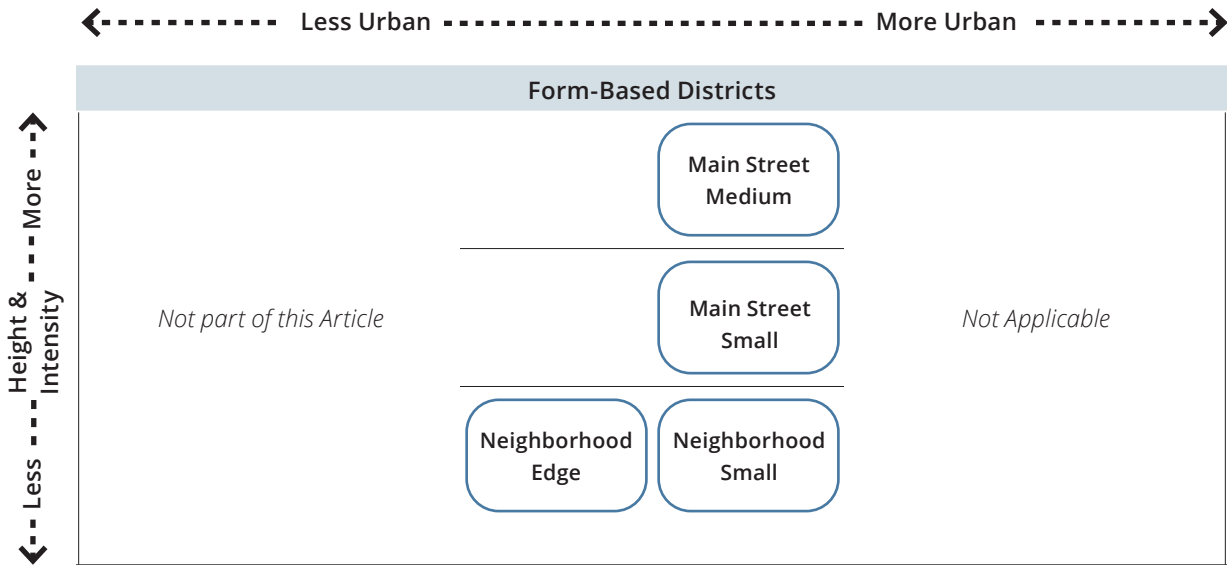

Chapter 1: Introduction

Sections:

1.010	Purpose
1.020	Applicability
1.030	Relationship to the Sebastopol General Plan
1.040	Relationship to City of Sebastopol Municipal Code

1.010 Purpose

This Objective Design Standards (ODS) sets forth the standards for neighborhood design, building form, and uses within form-based districts. These standards reflect the community's vision for implementing the intent of the Sebastopol General Plan to facilitate housing production and specifically infill housing production, through development that reinforces the highly valued character and scale of Sebastopol's walkable centers, neighborhoods, and corridors. This ODS also addresses the state of California's requirements for objective standards for qualifying multi-family and mixed-use projects as described in Government Code §65913.4.

1.020 Applicability

1. **Rules for Construction of Language.** The following general rules for construction of language apply to the text of this ODS:
 - A. **Tenses and Numbers.** Words used in the present tense include the future, words used in the singular include the plural, and the plural includes the singular, unless the context clearly indicates the contrary.
 - B. **Applicable.** The applicable standards of this ODS apply so as to not require stating the phrase "and all applicable standards" throughout this ODS.
 - C. **Conjunctions.** Unless the context clearly indicates otherwise, the following conjunctions shall be interpreted as follows:
 - (1) "And" indicates that all connected items or provisions apply;
 - (2) "Or" indicates that the connected items or provisions may apply; and
 - (3) "Either/or" indicates that the connected items or provisions apply singly but not in combination.
 - D. **Abbreviations.** The following terms are abbreviated:
 - (1) Property Line (PL);
 - (2) Maximum (Max.); Minimum (Min.); and
 - (3) Right-of-Way (ROW)
 - E. **Definitions.** The definitions supporting this Article are in Section 11.020 (Definitions).

- F. **Measurement Methods.** Certain terms used in this Article are further explained as to their measurement method (e.g., Building Height) in Chapter 11 (Definitions). See Section 11.030 (Measurement Methods) for this information.
- 2. In areas subject to this ODS, the standards in this ODS prevail unless stated otherwise.
- 3. This ODS applies to proposed development as identified in Table A (Applicability).

Table 1.020.A: Applicability			
Development Type	Housing Accountability Act (HAA) Applies¹	Senate Bill 330 Applies¹	Senate Bill 35 Applies²
Single-Unit House	No	No	No
Transitional Housing	Yes	Yes	See Multi-Family Housing (2 or more residential units)
Supportive Housing	Yes	Yes	
Emergency Shelter	Yes	Yes	
Farmworker Housing	Yes	Yes	
Multi-Family Housing (2 or more residential units)			
Affordable	Yes	Yes	Yes
Market Rate ³	Yes	Yes	No
Mixed-Use Development (at least 2/3 of square footage designated for residential units)			
Affordable	Yes	Yes	Yes
Market Rate ³	Yes	Yes	No
Other Development			
Non-Mixed-Use ⁴	No	No	No
Non-Residential	No	No	No
Additions and Modifications			
Previously approved under this Article	See this Article		
Not approved under this Article	See Title 17 (Zoning)		

¹ See Government Code §65589.5 for additional eligibility criteria and specific protections by development type.

² See Government Code §65913.4(a) for additional eligibility criteria (e.g., site standards, affordability provisions, and labor provisions).

³ "Market Rate" refers to projects that do not contain the minimum percentage of affordable housing units to be eligible for Senate Bill 35 streamlining. See Footnote 2.

⁴ Less than 2/3 of square footage designated for residential units.

- 4. As required by Table A (Applicability), the standards in this ODS apply to existing development as specified and to all proposed development within form-based districts ("districts") as identified below.

A. General

- (1) From the allowed types in the district, and in compliance with the listed standards, the following shall be selected for each design site:
 - (a) Only one building type per design site is allowed, except a Carriage House may be included within a design site in addition to the primary building type. Parcels with enough land area

to meet the district standards for minimum design site width and depth may have multiple building types;

- (b) The standards of this Article do not regulate density; however, all new or modified buildings shall be in compliance with the maximum allowed density by the Sebastopol General Plan;
 - (c) At least one private frontage type; and
 - (d) At least one use type.
- (2) Building types and private frontage types not listed in the district's standards are not allowed in that district.
 - (3) Uses
 - (a) See underlying existing zoning for allowed uses.
 - (4) New buildings and their improvements are subject to Sebastopol's local standards for Fire Safety and Building Safety.
 - (5) Sebastopol's standards for Accessory Dwelling Units (ADU) and Junior Accessory Dwelling Units (JADU) apply. See Chapter 17.220 (Accessory Dwelling Units).

B. Site Standards. Chapter 4 (General to Design Sites)

- (1) **Screening.** The standards of Section 4.020 (Screening) apply to the following:
 - (a) All new development; and
 - (b) Improvements to existing development.
- (2) **Landscaping and Tree Standards.** The standards of Section 4.030 (Landscaping and Lighting) apply to the following:
 - (a) New primary building(s); and/or
 - (b) Site improvements to existing development.
- (3) **Parking and Loading.** The standards of Section 4.040 (Parking and Loading) apply to the following:
 - (a) New development;
 - (b) Changes in land use; and/or
 - (c) Changes in intensity of buildings or structures made after the effective date of this ODS that cause an increase or decrease of 25 percent or greater in:
 - i. Gross floor area;
 - ii. Seating capacity;
 - iii. Units; and/or
 - iv. Parking spaces.
- (4) **Slope Standards.** The standards of Section 4.050 (Slope Standards) apply to portions of design sites with grades of at least six percent.
- (5) **Public Frontage Standards.** The standards of Section 4.060 (Public Frontage Standards) apply to existing and proposed streets, in any of the following situations:

- (a) New primary building(s);
 - (b) Addition(s) over 50 percent of the existing floor area of primary building;
 - (c) Facade renovation(s) to primary building along front street or secondary front yard; and/or
 - (d) New block(s).
- (6) Privacy Standards. The standards of Section 4.070 (Privacy Standards) apply to existing and proposed streets, in any of the following situations:
- (a) New primary building(s);
 - (b) Addition(s) over 50 percent of the existing floor area of primary building; and/or
 - (c) Facade renovation to primary building along interior side design site line.
- C. **Building Type Standards.** The standards of Chapter 5 (Specific to Building Types) apply to the following:
- (1) New buildings (except public safety buildings); and
 - (2) Additions (except public safety buildings).
- D. **Private Frontage Type Standards.** The standards of Chapter 6 (Specific to Private Frontage Types) apply to the following:
- (1) New buildings;
 - (2) Building facade renovation facing a street or open space (except public safety buildings);
 - (3) Private property improvement along front street or secondary front yard; and
 - (4) Modification of pedestrian entrance(s) along front street or secondary front yard.
- E. **Sign Type Standards.** The standards of Chapter 8 (Specific to Signage Types) apply to the following:
- (1) All signs regardless of their nature or location and unless specifically exempted, which are intended to be viewed from a public right-of-way and from outdoors in areas of public and private property used for public pedestrian access; and
 - (2) Where a conflict exists between Chapter 8 (Specific to Signage Types) and the sign standards established in Chapter 17.120 (Sign Regulations), Chapter 8 (Specific to Signage Types) applies.
- F. **Architectural Design Standards.** The standards of Chapter 7 (Specific to Architectural Design) apply to the following:
- (1) New buildings; and
 - (2) Building facade renovations that propose a change to any of the following: wall finishes, window trim finishes, roof materials, size of opening(s), architectural detail(s). The standards of Chapter 7 (Specific to Architectural Design) shall only apply to those elements being changed (except public safety buildings).
- G. **Walkable Community Design**
- (1) **New Development.** New development on a design site of at least three acres or at least 700 feet long or deep is required to be designed in compliance with Chapter 9 (Specific to Large Sites).
 - (2) **Blocks and Streets**

- (a) Development sites larger than three acres or at least 700 feet long or deep shall be divided into new blocks in compliance with Subsection 9.030.3.A.(4) (Block Size).
 - (b) New streets are required to form blocks in compliance with Table 9.020.A (Block Size Standards).
 - (c) When designing a new street or retrofitting an existing street, the standards in Section 9.040 (General to Thoroughfares) apply.
- (3) **Design Sites**
- (a) New buildings are required to be designed in compliance with the design site width and depth standards of the district.
 - (b) This ODS does not require the recordation of design site lines. The design site width and depth standards are for the purpose of consistently achieving pedestrian-oriented and scaled buildings.
- (4) **Open Space Standards.** Development sites larger than three acres are required to create new open space(s) in compliance with the standards of Chapter 9 (Specific to Large Sites) and Section 9.030 (General to Open Space).
- H. **Nonconforming Situations.** The standards of Chapter 17.160 (Nonconforming Uses) apply to all nonconforming situations.
- I. **Procedures.** Applications for development are to be processed in compliance with the procedures identified in Section 10.020 (Procedures). Requests for administrative relief are to be processed in compliance with the procedures in Section 10.020 (Procedures) and the required findings in Section 10.030 (Adjustments to Standards).

1.030 Relationship to the Sebastopol General Plan

This ODS implements Sebastopol's General Plan vision through a palette of form-based districts described in Chapter 2 (Establishment of Districts). This ODS is applied to walkable environments, existing or new. Walkable is described as an environment that is pedestrian-oriented in nature, with a variety of housing choices, where bicycling and walking are viable daily options because services, retail, or restaurants are within 2,000 linear feet of most residences in the development.

1.040 Relationship to City of Sebastopol Municipal Code

This ODS (Article 2) has been integrated with the City of Sebastopol Municipal Code. The requirements of this ODS prevail unless stated otherwise.

This page intentionally left blank

Chapter 2: Establishment of Districts

Sections:

- 2.010 Purpose
- 2.020 Districts Established
- 2.030 Sub-Districts
- 2.040 Form-Based District Map

2.010 Purpose

This Chapter establishes the palette of form-based districts ("districts") to implement the Sebastopol General Plan, and the Sebastopol transect as described in the Preamble of this ODS. The districts are for the purpose of generating and supporting the variety and physical character of existing and new walkable environments.

2.020 Districts Established

This Section identifies the districts, based on the intended physical form and character of the environments described in the Preamble of this ODS. These districts focus on mixed-use, walkable environments and range in function and intensity from primarily residential areas with a mix of lower intensity building types (T3 Neighborhood Edge), to moderate intensity neighborhoods (T4 Neighborhood.Small), and moderate-intensity centers (T4 Main Street.Small and T4 Main Street.Medium).

2.030 Sub-Districts

1. Sub-districts are slight variations of the base district (e.g., T4 Neighborhood.Small-Open), are design site-specific, and mapped on the Sebastopol Form-Based District Map. The ODS includes one type of sub-district:
 - A. **Open.** The open sub-district is applied in specific areas for either or both of the following purposes:
 - (1) To allow more uses, frontages, and signage types than the base district allows, but within the same form and character of the base district (e.g., T4 Neighborhood.Small); and/or
 - (2) To more easily allow certain uses that are already allowed in the base district.

2.040 Form-Based District Map

The districts and sub-district established in this Section are mapped on the Sebastopol Form-Based District Map. When any of these districts are applied, the Form-Based District Map shall be updated to reflect such changes.

Chapter 3: Districts

Sections:

3.010	Purpose
3.020	General Requirements
3.030	T3 Neighborhood Edge (T3NE)
3.040	T4 Neighborhood.Small (T4N.S)
3.050	T4 Main Street.Small (T4MS.S)
3.060	T4 Main Street.Medium (T4MS.M)
3.070	Adjacency Requirements

3.010 Purpose

This Chapter provides districts and standards to implement the Sebastopol General Plan to generate and support the variety of physical character of the intended development.

3.020 General Requirements

1. Topics Regulated

The ODS uses a palette of four form-based districts to regulate and generate the intended physical character. Each district ("district") regulates nine topics:

- A. Intent: the intended physical character and range of uses;
- B. Sub-districts: whether or not a sub-district applies, allowing a broader list of building types and/or frontage types in specific geographic areas;
- C. Building type and design site size: the menu of allowed building types and the associated minimum site dimensions. See Subsection 3.020.4 for an explanation of the design site approach.
- D. Building form: the maximum overall building height, minimum ground floor height, and maximum building footprint (coverage);
- E. Building placement: the minimum to maximum building setbacks and requirements for façade design;
- F. Encroachments: allowed encroachments into required setbacks;
- G. Parking: the required location and design requirements for parking and vehicle access;
- H. Frontages: the menu of allowed frontage types required at building entries along thoroughfares and open space; and
- I. Signage: the menu of allowed signage types.

2. Parcels that vary in width or depth shall be measured using the average width and/or depth to apply the standards of this Chapter.

3. On-Site Parking and Vehicle Access

- A. Bicycles may be parked anywhere on design sites, in compliance with pedestrian and vehicular access standards.
- B. Driveways may be shared among adjacent design sites but shall not exceed maximum allowed width.
- C. Vehicular access from the front is not allowed on corner design sites, except where secondary front yard access cannot be provided.
- D. See parking requirements in Section 17.110.020 (Off-street Parking Required).
- E. Parking spaces may be grouped with those on adjacent design sites (see Section 3020.5) and may be detached from development sites within the same block or across a paseo.
- F. Where structured parking is provided, buildings are allowed to abut the parking structure and are exempt from minimum design site depth and rear building setbacks.
- G. Subterranean Parking. Subterranean and semi-subterranean garages are subject to the following, in compliance with the requirement for habitable ground floor space in Subsection 5 of the district:
 - (1) Subterranean garages are exempt from the required parking setbacks and building setbacks.
 - (2) Semi-subterranean garages:
 - (a) Are exempt from the required parking setbacks;
 - (b) Are subject to the building setbacks of the district;
 - (c) May project above the adjacent finished grade by up to 2 feet.
 - (3) Design sites that provide all required parking in a subterranean or semi-subterranean garage are exempt from minimum and maximum design site size requirements.

Missed Edit(s):

Add the following standards (subsection numbering to be updated in Adoption Hearing Draft):

- 3. Development standards in this Chapter apply to primary buildings.
- 4. For parcels located in the 100 year floodplain, overall maximum height is the sum of the Base Flood Elevation plus 24 inches plus the maximum height to the highest eave or overall (T3NE, T4N.S, T4MS.S), or to the maximum height overall (T4MS.M) allowed by the district.
- 5. Individual building types have specific standards in Chapter 5 (Specific to Building Types) in addition to the district standards to further calibrate each type for its context.
- 6. Facade Zone
 - A. Each building type is required to be placed on the parcel in compliance with the requirements for facade zone defined by primary building/frontage in Subsection 5 of the district.
 - B. Facades are allowed to be in any configuration if in compliance with the facade zone requirements and the architectural style.
 - C. In the Cottage Court and Pocket Neighborhood building types, only the frontmost building(s) are subject to the facade zone requirements except for the minimum length (percentage) in Subsection 5 of the district.
 - D. In the Neighborhood Courtyard type, the frontmost portions of the building are subject to the facade zone requirements except for the minimum length (percentage) in Subsection 5 of the district.

4. **Design Sites.** A design site is a parcel or portion of land within a parcel that is delineated from other design sites and/or parcels to accommodate only one primary building or building type. Design sites are treated like parcels for the purpose of applying development standards, but are not required to be legally subdivided into individual parcels. A parcel can include multiple design sites, in compliance with Subsection 3 of the district.
 - A. Each design site is required to front onto the adjacent street or internal pedestrian circulation network, whichever is closer.
 - B. Design sites do not include the area of the public frontage assembly as required by Section 4.060 (Public Frontage Standards).
 - C. Table 3.020.A identifies the requirements for projects which include a portion of a parcel, an entire parcel, or multiple parcels.

Table 3.020.A Applicability of Design Site Requirements	
Project Criteria	Reference to Standards
Project area is at least three acres	Walkable Neighborhood Plan in compliance with Section 8.030 (Large Site Standards)
The linear dimension of the project area along a thoroughfare or as measured perpendicular to an adjacent thoroughfare is at least 400 feet	
Project area is through lot of at least one acres	
Project area includes design site(s) which do(es) not front onto an existing public street, within a parcel of at least three acres	Compliance with the requirements in Figure 3.020.1 (Applying Design Sites on Existing Right of Way Network)
Project area includes design site(s) which front(s) onto an existing public street, within a parcel of less than three acres	
Project area includes design site(s) which do(es) not front onto an existing public street, within a parcel of less than three acres	
	Compliance with the requirements in Figure 3.020.2 (Applying Design Sites on a Pedestrian Circulation Network)

Figure 3.020.1 Applying Design Sites on Existing Right of Way Network

1 Identify District(s)

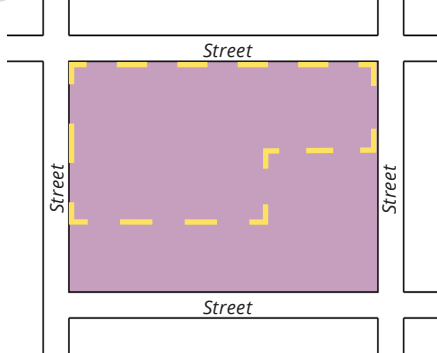

1. Identify District(s)
 - A. See Form-Based District Map.
 - B. See Chapter 3 (Districts) for design site requirements.

2 Apply Design Sites

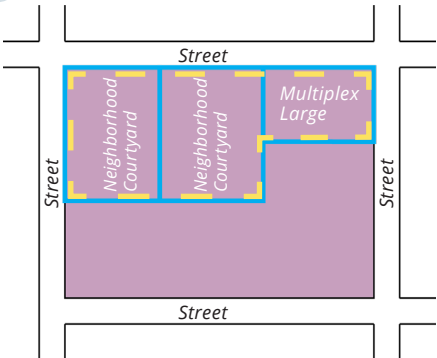

2. Apply Design Sites
 - A. Each design site is required to front onto the adjacent street.
 - B. As required in Chapter 9 (Specific to Large Sites), the applicable public frontage assembly identified by Section 4.060 (Public Frontage Standards) shall be provided along front and secondary front yard edges of design sites.
 - C. Select only 1 building type for each design site from the allowed building types for the district and apply the required dimensional standards. (See Subsection 3 of each district in Chapter 3).

3 Place Buildings

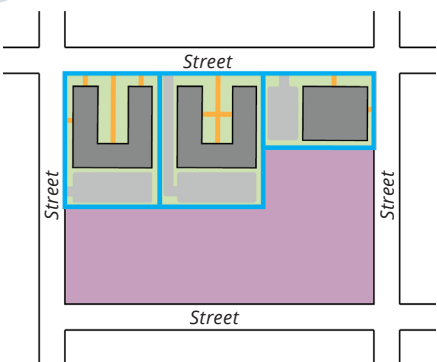

3. Place Buildings
 - A. Place each primary building on its design site in compliance with the required setbacks and other standards of the district (see Chapter 3).
 - B. Each building is required to front onto the adjacent street or open space.
 - C. Select and apply frontage types to each building/unit entry (see Subsection 8 of the district).

Key

- | | | | |
|------------------|------------------|--------------------------|-------------|
| Project Area | Primary Building | Vehicle Access & Parking | Landscaping |
| Design Site Line | Example District | Pedestrian Circulation | |

Missed Edit:
Fixed text overlapping line above key

Figure 3.020.2 Applying Design Sites on a Pedestrian Circulation Network

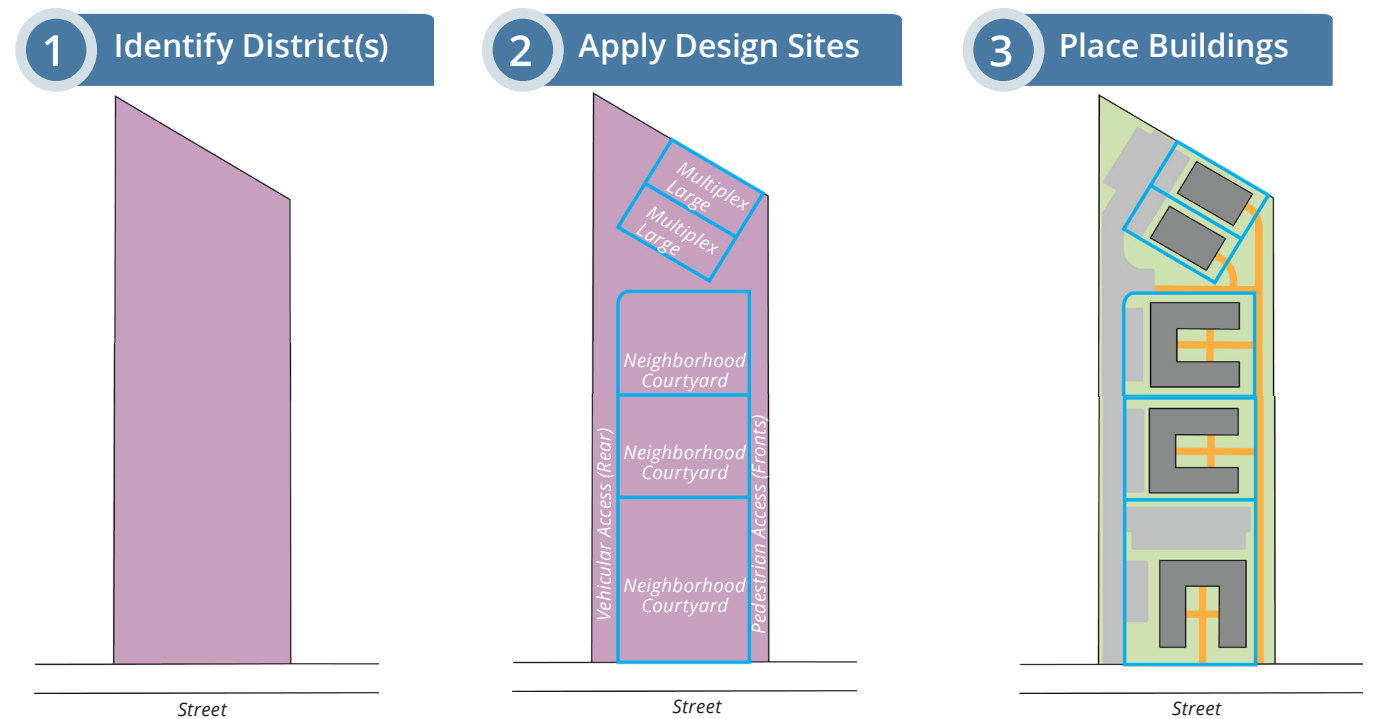

1. Identify District(s)
 - A. See Form-Based District Map.
 - B. See Chapter 3 (Districts) for design site requirements.

2. Apply Design Sites
 - A. Define contiguous internal circulation networks for pedestrians and vehicles, and arrange design sites to front onto the pedestrian network or the public frontage assembly, whichever is closer. The pedestrian circulation network shall be separate from vehicular circulation.
 - B. Select only 1 building type per design site and apply the dimensional standards for the design site of each selected building type in compliance with Subsection 3 of the district.
 - C. Design sites are allowed to occupy some or all of a parcel. Parcel remainder may be added to design sites, or used for parking, circulation, and/or common or open space.

3. Place Buildings
 - A. Place each primary building on its design site in compliance with the required setbacks and other standards of the district (see Chapter 3).
 - B. Parking for a building is not required to be located on the same design site.
 - C. Select and apply frontage types to each building/unit entry (see Subsection 8 of the district).

Key

- | | | |
|------------------|--------------------------|------------------------|
| Primary Building | Vehicle Access & Parking | Landscaping |
| Design Site Line | Example District | Pedestrian Circulation |

This page intentionally left blank

Table A (Districts Overview) provides an overview of each district and its intent. This information is to show how the broader transects in Table P-1F-A (Sebastopol Transect) have been applied, and as qualitative background information on the intended physical character, allowed range of uses, and direction for the detailed standards in each district.

Table 3.020.A: Districts Overview

◀ **Less Urban**

T3 Neighborhood Edge 3.030



District Abbreviation

T3NE

Sub-District(s)

None

Intent

A walkable neighborhood environment of small-to-medium footprint, low-to-moderate-intensity housing choices, supporting and within short walking distance of neighborhood-serving retail and services. See Section 17.20.020 for allowed uses.

Desired Form

House-Scale Buildings
 Primarily Detached Buildings
 Small-to-Medium Building Footprints
 Small-to-Medium Front Setbacks
 Small-to-Medium Side Setbacks
 Up to 2.5 Stories
 House, Duplex Side-by-Side, Cottage Court, Multiplex Small, Neighborhood Townhouse, Side Court, Neighborhood Courtyard, and Pocket Neighborhood
 Porch Projecting, Porch Engaged, and Dooryard Frontage Types

T4 Neighborhood.Small 3.040



District Abbreviation

T4N.S

Sub-District(s)

T4N.S-Open. The open sub-district allows additional building, frontage, and signage types within the same form and character of the T4N.S district.

Intent

A walkable neighborhood environment of small-to-medium footprint, moderate-intensity housing choices, supporting and within short walking distance of neighborhood-serving retail and services. See Sections 17.20.020 and 17.25.020 for allowed uses.

Desired Form

House-Scale Buildings
 Primarily Detached Buildings
 Small-to-Medium Building Footprints
 Small-to-Medium Front Setbacks
 Small-to-Medium Side Setbacks
 Up to 3 Stories
 House, Duplex Side-by-Side, Cottage Court, Multiplex Small, Neighborhood Townhouse, Side Court, Neighborhood Courtyard, Pocket Neighborhood, and Multiplex Medium;
 Main Street Building in Open Sub-District
 Porch Projecting, Porch Engaged, Dooryard, and Stoop Frontage Types; Shopfront, Terrace, and Gallery Frontage Types in Open Sub-District

Table 3.020.A: Districts Overview (Continued)

More Urban 



T4 Main Street.Small 3.050

District Abbreviation

T4MS.S

Sub-District(s)

None

Intent

A walkable district of small-to-medium footprint, moderate intensity, mixed-use buildings and housing choices, supporting neighborhood-serving ground floor retail, food and services. See Section 17.25.020 for allowed uses.

Desired Form

Primarily House-Scale Buildings

Primarily Attached Buildings

Small-to-Medium Building Footprints

None-to-Small Front Setbacks

None-to-Small Side Setbacks

Up to 2.5 Stories

House, Cottage Court, Multiplex Small, Neighborhood Townhouse, Neighborhood Courtyard, Multiplex Medium, and Main Street Building

Porch Projecting, Porch Engaged, Dooryard, Stoop, Forecourt, Shopfront, Terrace, and Gallery Frontage Types; Maker Shopfront Frontage Type on Secondary Front Yard



T4 Main Street.Medium 3.060

District Abbreviation

T4MS.M

Sub-District(s)

None

Intent

A walkable district of medium-to-large footprint, moderate intensity, mixed-use buildings and housing choices, supporting neighborhood-serving ground floor retail, food and services. See Section 17.25.020 for allowed uses.

Desired Form

Block-Scale Buildings

Primarily Attached Buildings

Medium-to-Large Building Footprints

None-to-Small Front Setbacks

None-to-Small Side Setbacks

Up to 3 Stories

Multiplex Medium, Core Townhouse, Core Courtyard, and Main Street Building

Forecourt, Shopfront, Terrace, and Gallery Frontage Types; Dooryard and Maker Shopfront Frontage Types on Secondary Front Yard

This page intentionally left blank



General note: the illustrations above are intended to provide a brief overview of the district and are descriptive in nature.

1. Intent

A walkable neighborhood environment of small-to-medium footprint, low-to-moderate-intensity housing choices, supporting and within short walking distance of neighborhood-serving retail and services. See Section 17.20.020 for allowed uses.

The following are generally appropriate form elements in the district.

House-Scale Buildings

Primarily Detached Buildings

Small-to-Medium Building Footprints

Small-to-Medium Front Setbacks

Small-to-Medium Side Setbacks

Up to 2.5 Stories

House, Duplex Side-by-Side, Cottage

Court, Multiplex Small, Neighborhood

Townhouse, Side Court, Neighborhood

Courtyard, and Pocket Neighborhood

Porch Projecting, Porch Engaged, and Dooryard Frontage Types

2. Sub-District(s)

None

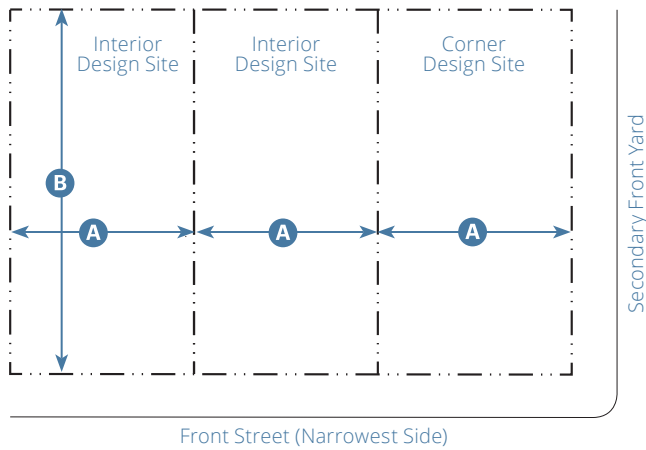

Key

--- ROW/ Design Site Line

3. Building Types and Design Site Size			
Allowed Building Types	Design Site ¹		Standards
	Width A	Depth B	
House-Scale			
House	50' min.	100' min.	5.040
Duplex Side-by-Side	55' min.	100' min.	5.050
Cottage Court	125' min.	130' min.	5.060
Multiplex Small	50' min.	100' min.	5.070
Neighborhood Townhouse	24' min. ²	100' min.	5.080
Side Court	65' min.; 100' max.	100' min. ³	5.090
Neighborhood Courtyard	70' min. ⁴	110' min.	5.100
Pocket Neighborhood	170' min.; 300' max.	260' min.; 500' max.	5.110

Block-Scale

None

¹ See Table 3.020.A for Large Site applicability requirements.

² Represents one townhouse

³ Over 150' requires fire truck turnaround area

⁴ For an L-shaped building; 100' min. for a U-shaped building

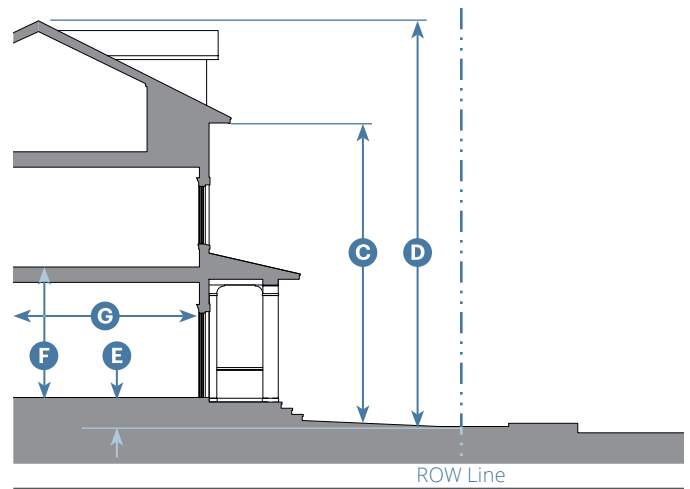

Key

--- ROW Line

4. Building Form		
Height		
Primary Building⁵		
Stories	2.5 max.	
To Highest Eave/Parapet	22' max.	C
Overall	30' max.	D
Ground Floor Finish Level	6" min. ⁶	E
Floor-to-Floor (Ground Floor)	10' min.	F
Footprint		
Max. Design Site Coverage	50% max.	
Depth, Habitable Ground-Floor Space ⁷		G
All Building Types	30' min.	
Cottage Court	12' min.	

⁵ See Chapter 5 (Specific to Building Types) for refinements to massing and height standards.

⁶ Common entries may be set at grade in compliance with local and federal accessibility standards.

⁷ For habitable/occupiable space only, except in the Cottage Court Building Type

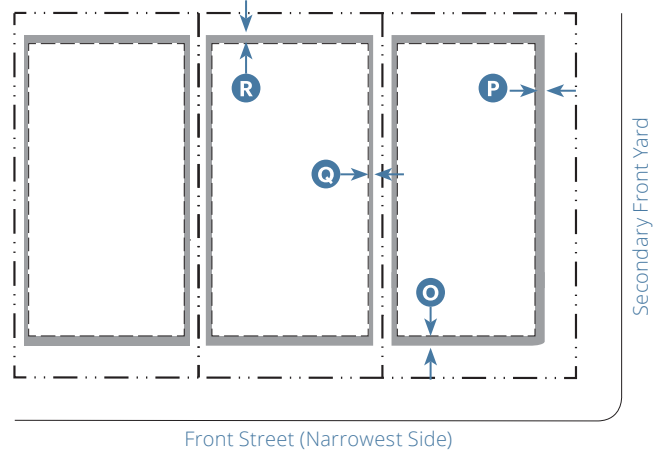
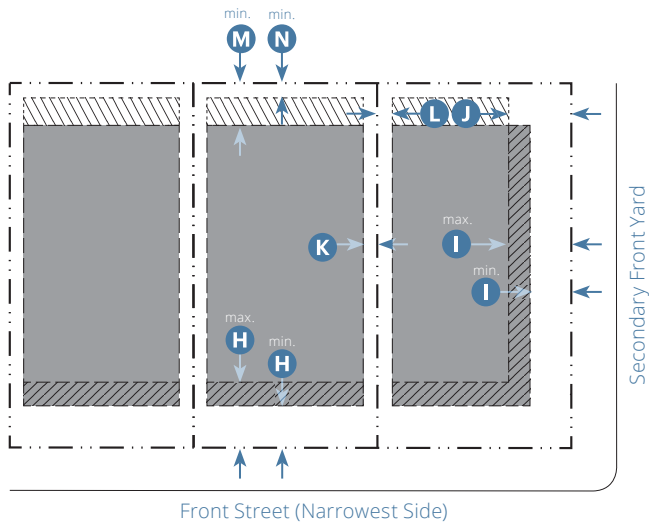

Key	Buildable Area
- - - - -	ROW/ Design Site Line
- - - - -	Building Setback Line
Acc. Structures Only	
Facade Zone	

5. Building Placement

Setback (Distance from ROW/ Design Site Line)⁸

Front (Facade Zone)		H
Interior Design Site	15' min.; 25' max.	
Corner Design Site	15' min.; 25' max.	
Secondary Front Yard (Facade Zone)		
Primary Building	10' min.; 20' max.	I
Accessory Structure(s)	20' min.	J
Side		
Primary Building	10' min.	K
Accessory Structure(s)	5' min.	L
Rear		
Primary Building	20' min.; 30' max.	M
Accessory Structure(s)	5' min.	N

Building Facade

Facade Zone	Front St.	S.F.Y.
Facade Zone Defined by Primary Building/Frontage (Subsection 11.030.2)	60% min.	50% min.

Facade Design

All building facades shall be designed in compliance with Chapter 7 (Specific to Architectural Design).

⁸Design sites with slopes ≥ 6% shall be designed in compliance with Section 4.050 (Slope Standards).

Key	Encroachment Area
- - - - -	ROW/ Design Site Line
- - - - -	Setback Line

6. Encroachments

Encroachments into Minimum Setbacks

Encroachment Type	Front O	S.F.Y. P	Side Q	Rear R
Private Frontages	10' max.	10' max.	---	---
Architectural Features	4' max.	4' max.	3' max.	8' max.
Patio Covers	---	---	3' max.	8' max.
Stairs/Ramps ⁹	4' max.	4' max.	3' max.	8' max.
Decks (24" Tall Max.)	---	5' max.	5' max.	20' max.

Ramps providing ADA or FHA visitability are allowed within setbacks but shall not encroach within public ROWs.

Fences, hedges, and other screen devices are allowed within setbacks as identified in Section 4.020 (Screening).

Encroachments into Public Right of Ways (ROW)

Encroachments are not allowed into a street ROW, alley ROW, or across a design site line.

No encroachment allowed for Accessory Structures

⁹Stairs that are part of a private frontage may encroach into the setback an additional 3' beyond the allowed encroachment of the private frontage but not into the public ROW.

Key	--- = Not Allowed	N/A = Not Applicable
	S.F.Y. = Secondary Front Yard	

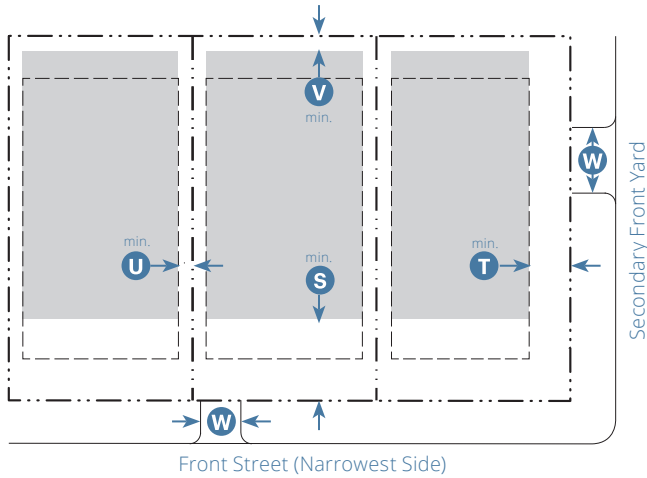

Key

- · - · - ROW/ Design Site Line
- - - Building Setback Line
- Parking Area

7. Parking		
Setback (Distance from ROW/ Design Site Line)		
Front	45' min.	S
Secondary Front Yard	10' min. beyond 45' of front design site line	T
Side	5' min.	U
Rear	5' min.	V
Driveway ¹⁰		
Curb Cut/Width	See Resolution No. 6371-2021 (Street Standards)	W

¹⁰ See Subsection 22.05.040.8.B for additional standards.

8. Frontages	
Allowed Private Frontage Types	Standards
Porch Projecting	6.040
Porch Engaged	6.050
Dooryard	6.060
Allowed Public Frontage Types	Standards
Neighborhood Street	4.060.C.1
9. Signage	
Allowed Sign Types	Standards
None	



General note: the illustrations above are intended to provide a brief overview of the district and are descriptive in nature.

1. Intent

A walkable neighborhood environment of small-to-medium footprint, moderate-intensity housing choices, supporting and within short walking distance of neighborhood-serving retail and services. See Sections 17.20.020 and 17.25.020 for allowed uses.

The following are generally appropriate form elements in the district.

House-Scale Buildings

Primarily Detached Buildings

Small-to-Medium Building Footprints

Small-to-Medium Front Setbacks

Small-to-Medium Side Setbacks

Up to 3 Stories

House, Duplex Side-by-Side, Cottage

Court, Multiplex Small, Neighborhood

Townhouse, Side Court, Neighborhood

Courtyard, Pocket Neighborhood, and

Multiplex Medium

Porch Projecting, Porch Engaged,

Dooryard, and Stoop Frontage Types

2. Sub-District(s)

T4N.S-Open. The open sub-district allows additional building, frontage, and signage types within the same form and character of the T4N.S district.

Main Street Building

Shopfront, Terrace, and Gallery

Frontage Types

Projecting, Awning/Canopy, Wall,

Window, Sidewalk, and Directory

Signage Types

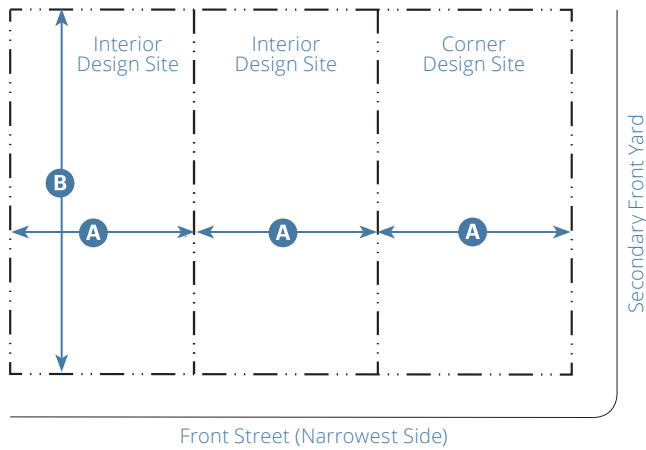

Key

--- ROW/ Design Site Line

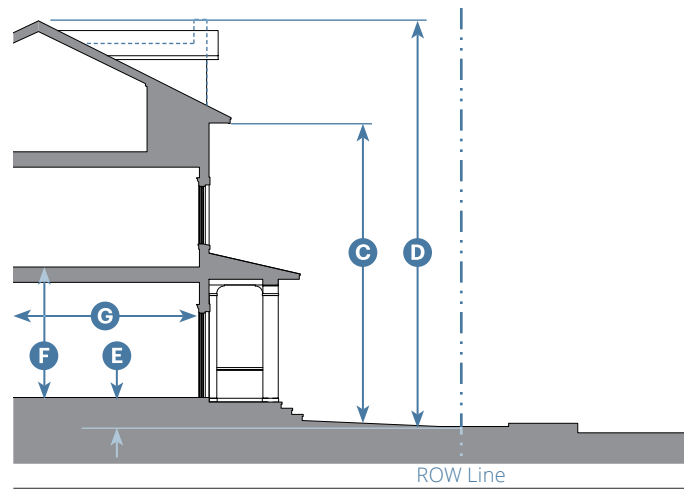

Key

--- ROW Line

3. Building Types and Design Site Size			
Allowed Building Types	Design Site ¹		Standards
	Width A	Depth B	
House-Scale			
House	50' min.	100' min.	5.040
Duplex Side-by-Side	50' min.	100' min.	5.050
Cottage Court	90' min.	120' min.	5.060
Multiplex Small	50' min.	100' min.	5.070
Neighborhood Townhouse	18' min. ²	100' min.	5.080
Side Court	65' min.; 100' max.	100' min. ³	5.090
Neighborhood Courtyard	70' min. ⁴	110' min.	5.100
Pocket Neighborhood	170' min.; 300' max.	260' min.; 500' max.	5.110
Multiplex Medium	75' min.	125' min.	5.120
Block-Scale			
Main Street Building ⁵	25' min.; 50' max.	100' min	5.150

¹ See Table 3.020.A for Large Site applicability requirements.

² Represents one townhouse

³ Over 150' requires fire truck turnaround area

⁴ For an L-shaped building; 100' min. for a U-shaped building

⁵ Allowed only in the T4N.S-Open Sub-district

4. Building Form	
Height	
Primary Building⁵	
Stories	3 max.
To Highest Eave	24' max. C
Top of Parapet/Overall	35' max. ⁶ D
Ground Floor Finish Level	E
Residential	6" min. ⁷
Non-Residential	6" max.
Floor-to-Floor (Ground Floor)	F
Residential	10' min.
Non-Residential	12' min.
Footprint	
Max. Design Site Coverage	50% max.
Depth, Habitable Ground-Floor Space ⁸	G
All Building Types	20' min.
Cottage Court	12' min.

⁵ See Chapter 5 (Specific to Building Types) for refinements to massing and height standards.

⁶ See Subsection 17.100.020.A for requirements for elements that may exceed overall height.

⁷ Common entries may be set at grade in compliance with local and federal accessibility standards.

⁸ For habitable/occupiable space only, except in the Cottage Court Building Type

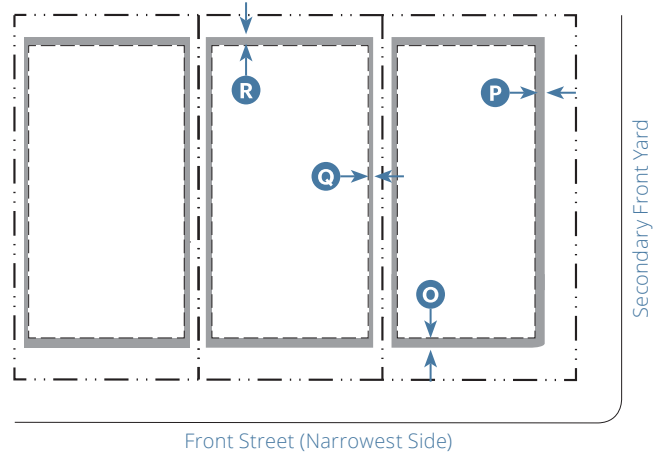
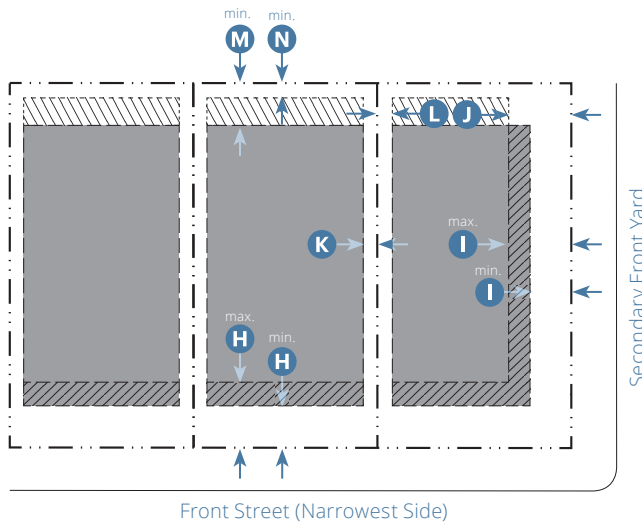

Key	Buildable Area
- · - · - ROW/ Design Site Line	Acc. Structures Only
- - - Building Setback Line	Facade Zone

Key	Encroachment Area
- · - · - ROW/ Design Site Line	
- - - Setback Line	

5. Building Placement

Setback (Distance from ROW/ Design Site Line)⁹

Front (Facade Zone)		H
Interior Design Site	10' min.; 20' max. ¹⁰	
Corner Design Site	10' min.; 20' max. ¹⁰	
Secondary Front Yard (Facade Zone)		
Primary Building	10' min.; 20' max. ¹⁰	I
Accessory Structure(s)	20' min.	J
Side		
Primary Building	See underlying zone	K
Accessory Structure(s)	5' min.	L
Rear		
Primary Building	20' min.	M
Accessory Structure(s)	5' min.	N

Building Facade

Facade Zone	Front St.	S.F.Y.
Facade Zone Defined by Primary Building/Frontage (Subsection 11.030.2)	65% min.	55% min.

Facade Design

All building facades shall be designed in compliance with Chapter 7 (Specific to Architectural Design).

⁹ Design sites with slopes ≥ 6% shall be designed in compliance with Section 4.050 (Slope Standards).

¹⁰ 3' min.; 10' max., for non-residential uses in T4N.S-O

6. Encroachments

Encroachments into Minimum Setbacks

Encroachment Type	Front O	S.F.Y. P	Side Q	Rear R
Private Frontages	10' max.	10' max.	---	---
Architectural Features	3' max.	3' max.	3' max.	5' max.
Patio Covers	---	---	3' max.	5' max.
Stairs/Ramps ¹⁰	3' max.	3' max.	3' max.	5' max.
Decks (24" Tall Max.)	---	5' max.	5' max.	20' max.

Ramps providing ADA or FHA visitability are allowed within setbacks but shall not encroach within public ROWs.

Fences, hedges, and other screen devices are allowed within setbacks as identified in Section 4.020 (Screening).

Encroachments into Public Right of Ways (ROW)

Encroachments are not allowed into a street ROW, alley ROW, or across a design site line.

No encroachment allowed for Accessory Structures

¹⁰ Stairs that are part of a private frontage may encroach into the setback an additional 3' beyond the allowed encroachment of the private frontage but not into the public ROW.

Key	--- = Not Allowed	N/A = Not Applicable
	S.F.Y. = Secondary Front Yard	

Missed Edit(s):
Added Footnote 10; footnote numbering to be updated in Adoption Hearing Draft

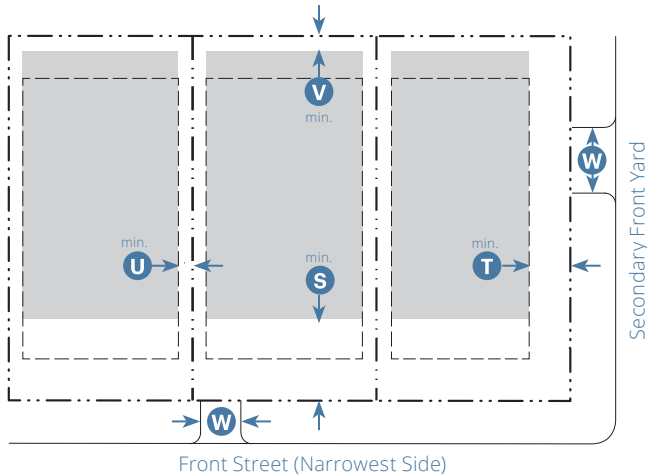

Key

- - - - ROW/ Design Site Line ■ Parking Area
- - - - Building Setback Line

7. Parking		
Setback (Distance from ROW/ Design Site Line)		
Front	30' min.	S
Secondary Front Yard	5' min. beyond 30' of front design site line	T
Side	5' min.	U
Rear	5' min.	V
Driveway ¹¹		
Curb Cut/Width	See Resolution No. 6371-2021 (Street Standards)	W

¹¹ See Subsection 22.05.040.8.B for additional standards.

8. Frontages	
Allowed Private Frontage Types	Standards
Porch Projecting	6.040
Porch Engaged	6.050
Dooryard	6.060
Stoop	6.070
Shopfront ¹²	6.100
Terrace ¹²	6.110
Gallery ¹²	6.120
Allowed Public Frontage Types	Standards
Neighborhood Street	4.060.C.1

¹² Open sub-district only

9. Signage	
Allowed Sign Types	Standards
Yard/Porch Sign	8.040
Projecting Sign ¹³	8.050
Awning/Canopy Sign ¹³	8.060
Wall Sign ¹³	8.070
Window Sign ¹³	8.090
Sidewalk Sign ¹³	8.100
Directory Sign ¹³	8.110

¹³ Open sub-district only



General note: the illustrations above are intended to provide a brief overview of the district and are descriptive in nature.

1. Intent

A walkable, vibrant district of small-to-medium footprint, moderate intensity, mixed-use buildings and housing choices, supporting neighborhood-serving ground floor retail, food and services. See Section 17.25.020 for allowed uses.

The following are generally appropriate form elements in the district.

Primarily House-Scale Buildings	House, Cottage Court, Multiplex
Primarily Attached Buildings	Small, Neighborhood Townhouse,
Small-to-Medium Building Footprints	Neighborhood Courtyard, Multiplex
None-to-Small Front Setbacks	Medium, and Main Street Building
None-to-Small Side Setbacks	Porch Projecting, Porch Engaged,
Up to 2.5 Stories	Dooryard, Stoop, Forecourt,
	Shopfront, Terrace, and Gallery
	Frontage Types; Maker Shopfront
	Frontage Type on Secondary Front
	Yard

2. Sub-District(s)

None.

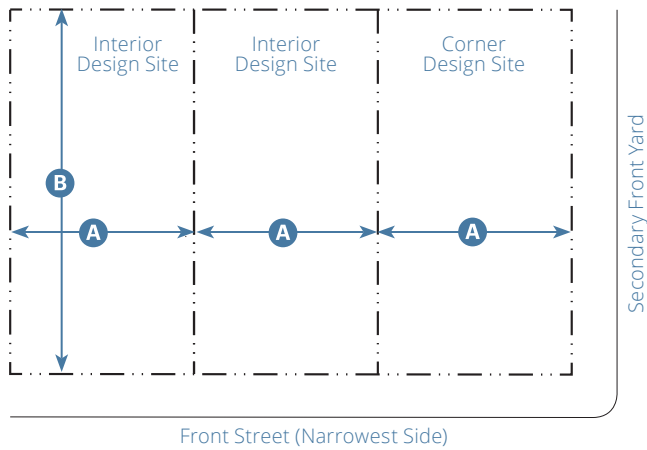

Key

--- ROW/ Design Site Line

3. Building Types and Design Site Size

Allowed Building Types	Design Site ¹		Standards
	Width A	Depth B	
House-Scale			
House	50' min.	100' min.	5.040
Cottage Court	90' min.	120' min.	5.060
Multiplex Small	50' min.	100' min.	5.070
Neighborhood Townhouse	18' min. ²	100' min.	5.080
Neighborhood Courtyard	70' min. ³	110' min.	5.100
Multiplex Medium	60' min.	110' min.	5.120

Block-Scale

Main Street Building	25' min.	100' min.	5.150
----------------------	----------	-----------	-------

¹ See Table 3.020.A for Large Site applicability requirements.

² Represents one townhouse

³ For an L-shaped building; 100' min. for a U-shaped building

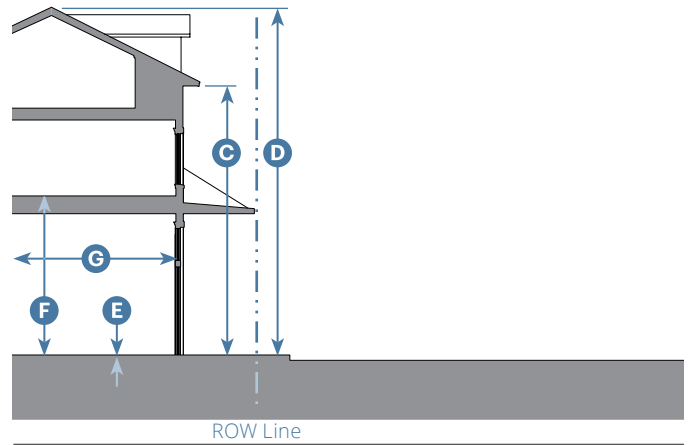

Key

--- ROW Line

4. Building Form

Height

Primary Building⁴

Stories	2.5 max.	
To Highest Eave	24' max.	C
Top of Parapet/Overall	32' max. ⁵	D
Ground Floor Finish Level		E
Residential	6" min. ^{6,7}	
Non-Residential	6" max. ⁹	
Floor-to-Floor (Ground Floor)		F
Residential	12' min.	
Non-Residential	14' min.	

Footprint

Max. Design Site Coverage	See standards in Chapter 5 (Specific to Building Types)	
Depth, Ground-Floor Space	30' min. ⁸	G

⁴ See Chapter 5 (Specific to Building Types) for refinements to massing and height standards.

⁵ See Subsection 17.100.020.A for requirements for elements that may exceed overall height.

⁶ Common entries may be set at grade in compliance with local and federal accessibility standards.

⁷ Only on secondary front yard and at least 60' from front of design site

⁸ Only for non-residential uses as allowed by underlying zone

⁹ Non-residential uses allowed by the underlying zoning are required within 50' of a street corner along South Main Street or Petaluma Avenue.

Missed Edit(s):
 Added Footnote 9; footnote numbering to be updated in Adoption Hearing Draft

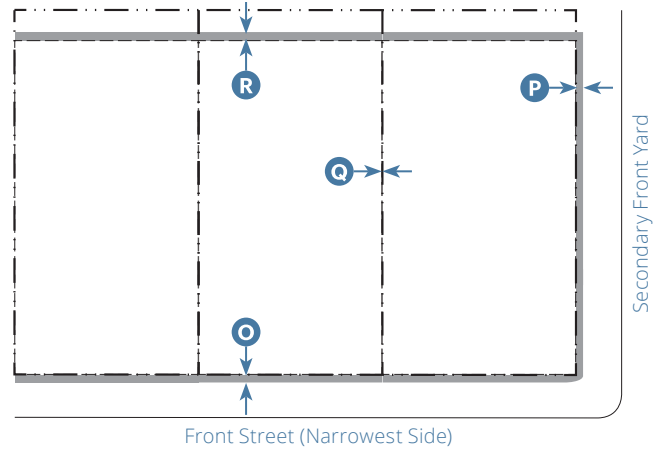
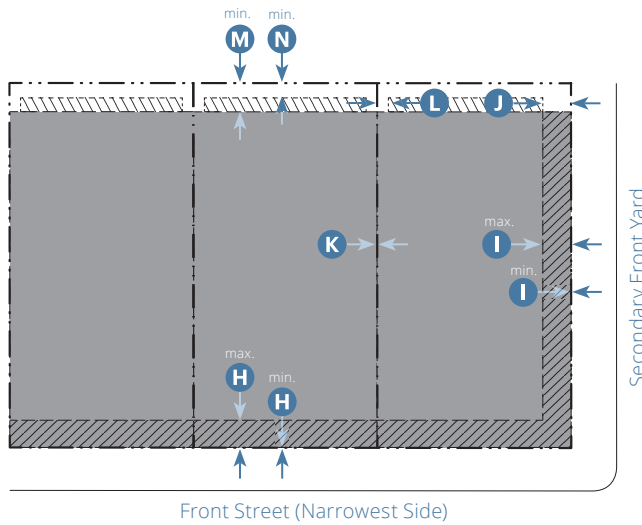

Key	Buildable Area
- - - - ROW/ Design Site Line	Acc. Structures Only
- - - - Building Setback Line	Facade Zone

5. Building Placement

Setback (Distance from ROW/ Design Site Line)⁹

Front (Facade Zone)		H
Interior Design Site	0' min.; 10' max. ¹⁰	
Corner Design Site	0' min.; 10' max. ¹⁰	
Secondary Front Yard (Facade Zone)		
Primary Building	0' min.; 10' max.	I
Accessory Structure(s)	10' min.	J
Side		
Primary Building	0' min.	K
Adjacent to T3NE or Res'I Zone	10' min.	
Accessory Structure(s)	5' min.	L
Rear		
Primary Building	20' min.	M
Adjacent to T3NE or Res'I Zone	20' min.	
Accessory Structure(s)	5' min.	N

Building Facade

Facade Zone	Front St.	S.F.Y.
Facade Zone Defined by Primary Building/Frontage (Subsection 11.030.2)	65% min.	55% min.

Facade Design

All building facades shall be designed in compliance with Chapter 7 (Specific to Architectural Design).

⁹Design sites with slopes \geq 6% shall be designed in compliance with Section 4.050 (Slope Standards).

¹⁰ 10' min., 20' max. on west side of South Main Street

Key	Encroachment Area
- - - - ROW/ Design Site Line	
- - - - Setback Line	

6. Encroachments

Encroachments into Minimum Setbacks

Encroachment Type	Front O	S.F.Y. P	Side Q	Rear R
Private Frontages	---	---	---	---
Architectural Features	3' max.	3' max.	---	5' max.
Patio Covers	---	---	---	5' max.
Stairs/Ramps ¹¹	3' max.	3' max.	---	5' max.
Decks (24" Tall Max.)	---	5' max.	5' max.	20' max.

Ramps providing ADA or FHA visitability are allowed within setbacks but shall not encroach within public ROWs.

Fences, hedges, and other screen devices are allowed within setbacks as identified in Section 4.020 (Screening).

Encroachments into Public Right of Ways (ROW)

Upper story encroachments on Front Street and Secondary Front Yard require 7' min. clearance.

No encroachment allowed for Accessory Structures

¹¹ Stairs that are part of a private frontage may encroach into the setback an additional 3' beyond the allowed encroachment of the private frontage but not into the public ROW.

Key	--- = Not Allowed	N/A = Not Applicable
	S.F.Y. = Secondary Front Yard	

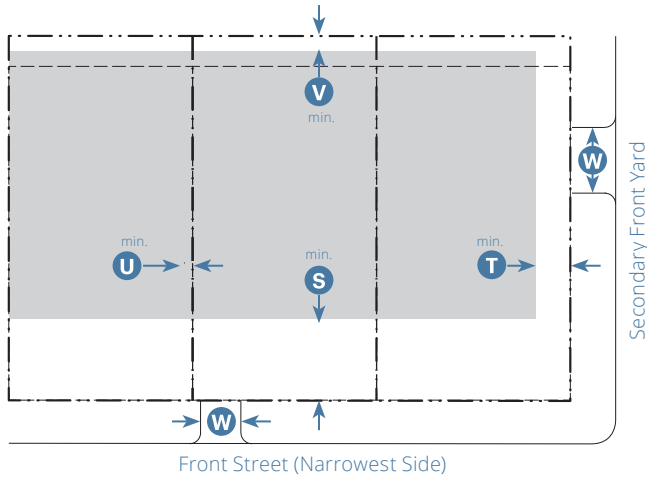

Key

- - - - ROW/ Design Site Line ■ Parking Area
- - - - Building Setback Line

7. Parking		
Setback (Distance from ROW/ Design Site Line)		
Front	30' min.	S
Secondary Front Yard	10' min. beyond 30' front design site line	T
Side	0' min.	U
Rear	5' min.	V
Driveway ¹²		
Curb Cut/Width	See Resolution No. 6371-2021 (Street Standards)	W

¹² See Subsection 22.05.040.8.B for additional standards.

8. Frontages	
Allowed Private Frontage Types	Standards
Porch Projecting	6.040
Porch Engaged	6.050
Dooryard	6.060
Stoop	6.070
Forecourt	6.080
Maker Shopfront ¹³	6.090
Shopfront	6.100
Terrace	6.110
Gallery	6.120
Allowed Public Frontage Types	Standards
Main Street	4.060.C.2

¹³ Only on secondary front yard and not within 50' of a street corner

9. Signage	
Allowed Sign Types	Standards
Yard/Porch Sign	8.040
Projecting Sign	8.050
Awning/Canopy Sign	8.060
Wall Sign	8.070
Painted Wall Sign	8.080
Window Sign	8.090
Sidewalk Sign	8.100
Directory Sign	8.110



General note: the illustrations above are intended to provide a brief overview of the district and are descriptive in nature.

1. Intent

A walkable, vibrant district of medium-to-large footprint, moderate intensity, mixed-use buildings and housing choices, supporting neighborhood-serving ground floor retail, food and services. See Section 17.25.020 for allowed uses.

The following are generally appropriate form elements in the district.

Block-Scale Buildings

Primarily Attached Buildings

Medium-to-Large Building Footprints

None-to-Small Front Setbacks

Up to 3 Stories

Multiplex Medium, Core Townhouse,

Core Courtyard, and Main Street

Building

Forecourt, Shopfront, Terrace, and Gallery Frontage Types; Dooryard and Maker Shopfront Frontage Types on Secondary Front Yard

2. Sub-District(s)

None.

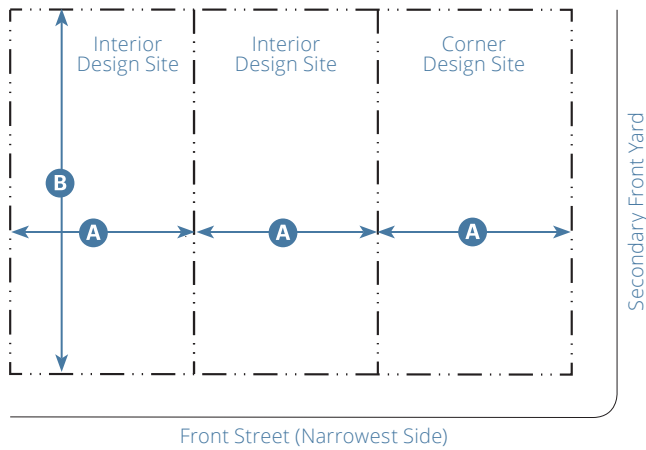

Key

--- ROW/ Design Site Line

3. Building Types and Design Site Size			
Allowed Building Types	Design Site ¹		Standards
	Width A	Depth B	
House-Scale			
Multiplex	60' min.	120' min.	5.120
Medium			
Block-Scale			
Core Townhouse	18' min. ²	100' min.	5.130
Core Courtyard	75' min. ³	120' min.	5.140
Main Street Building	25' min.	100' min.	5.150

¹ See Table 3.020.A for Large Site applicability requirements.

² Represents up to 2 stacked units

³ For an L-shaped building; 100' min. for a U- or O-shaped building

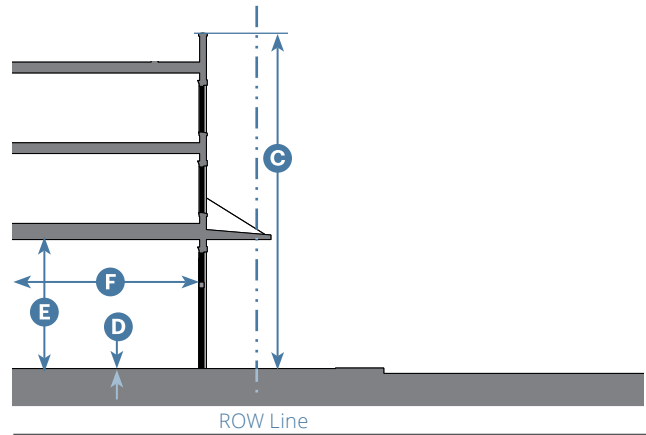

Key

--- ROW Line

4. Building Form		
Height		
Primary Building⁴		
Stories	3 max.	
Overall	40' max. ⁵	C
Ground Floor Finish Level D		
Residential	6" min. ^{6,7}	
Non-Residential	6" max.	
Floor-to-Floor (Ground Floor) E		
Residential	12'; Not allowed on ground floor within 30' of front of building	
Non-Residential	14' min.	
Footprint		
Max. Design Site Coverage	See standards in Chapter 5 (Specific to Building Types)	
Depth, Ground-Floor Space	30' min. ⁸	F

⁴ See Chapter 5 (Specific to Building Types) for refinements to massing and height standards.

⁵ See Subsection 17.100.020.A for requirements for elements that may exceed overall height.

⁶ Common entries may be set at grade in compliance with local and federal accessibility standards.

⁷ Only on secondary front yard and at least 60' from front of design site

⁸ Only for non-residential uses as allowed by underlying zone

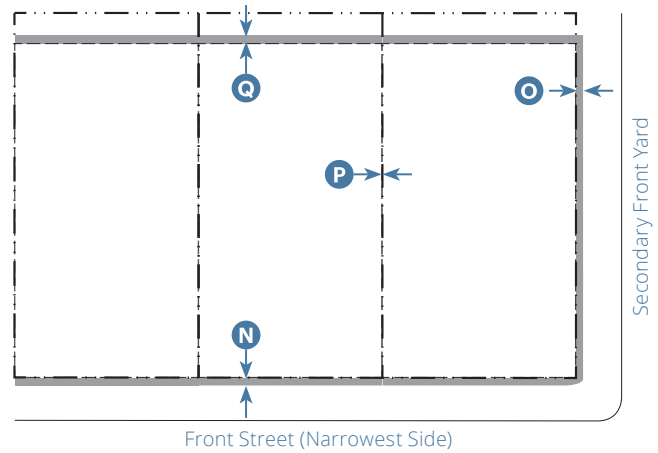
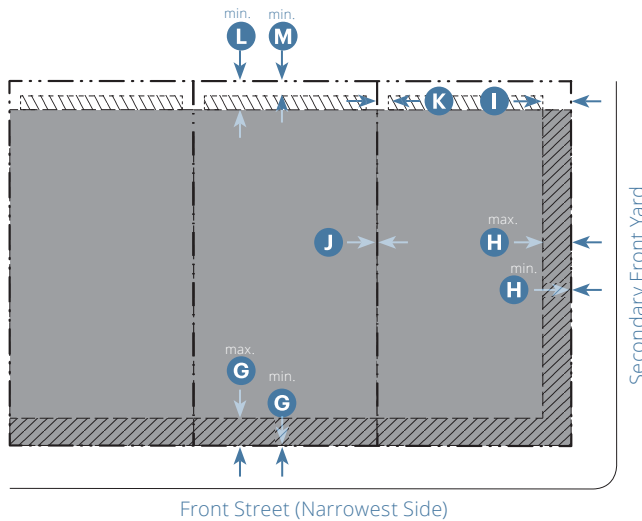

Key	Buildable Area
- · · · ROW/ Design Site Line	Acc. Structures Only
- - - Building Setback Line	Facade Zone

5. Building Placement

Setback (Distance from ROW/ Design Site Line)⁸

Front (Facade Zone)		G
Interior Design Site	0' min.; 10' max.	
Corner Design Site	0' min.; 10' max.	
Secondary Front Yard (Facade Zone)		
Primary Building	0' min.; 10' max.	H
Accessory Structure(s)	10' min.	I
Side		
Primary Building	0' min.	J
Adjacent to T3NE or Res'I Zone	10' min.	
Accessory Structure(s)	5' min.	K
Rear		
Primary Building	10' min.	L
Adjacent to T3NE or Res'I Zone	20' min.	
Accessory Structure(s)	5' min.	M

Building Facade

Facade Zone	Front St.	S.F.Y.
Facade Zone Defined by Primary Building/Frontage (Subsection 11.030.2)	80% min.	70% min.

Facade Design

All building facades shall be designed in compliance with Chapter 7 (Specific to Architectural Design).

⁸Design sites with slopes $\geq 6\%$ shall be designed in compliance with Section 4.050 (Slope Standards).

Key	Encroachment Area
- · · · ROW/ Design Site Line	
- - - Setback Line	

6. Encroachments

Encroachments into Minimum Setbacks

Encroachment Type	Front N	S.F.Y. O	Side P	Rear Q
Private Frontages	---	---	N/A	N/A
Architectural Features	3' max.	3' max.	---	2' max.
Patio Covers	---	---	---	2' max.
Stairs/Ramps ⁹	3' max.	3' max.	---	2' max.
Decks (24" Tall Max.)	---	5' max.	5' max.	20' max.

Ramps providing ADA or FHA visitability are allowed within setbacks but shall not encroach within public ROWs.

Fences, hedges, and other screen devices are allowed within setbacks as identified in Section 4.020 (Screening).

Encroachments into Public Right of Ways (ROW)

Upper story encroachments on Front Street and Secondary Front Yard require 7' min. clearance.

No encroachment allowed for Accessory Structures

⁹Stairs that are part of a private frontage may encroach into the setback an additional 3' beyond the allowed encroachment of the private frontage but not into the public ROW.

Key	--- = Not Allowed	N/A = Not Applicable
	S.F.Y. = Secondary Front Yard	

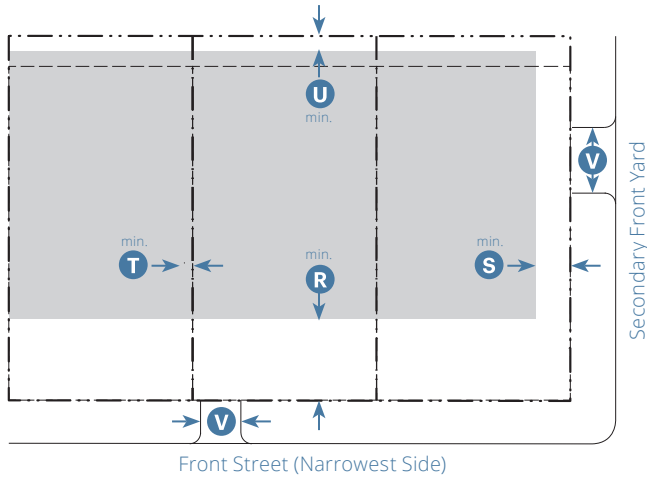

Key

- - - - ROW/ Design Site Line
- - - - Building Setback Line
- Parking Area

7. Parking		
Setback (Distance from ROW/ Design Site Line)		
Front	30' min.	R
Secondary Front Yard	10' min. beyond 30' from front of design site	S
Side	0' min.	T
Rear	5' min.	U
Driveway ¹⁰		
Curb Cut/Width	See Resolution No. 6371-2021 (Street Standards)	V

¹⁰ See Subsection 22.05.040.8.B for additional standards.

8. Frontages	
Allowed Private Frontage Types	Standards
Dooryard ¹¹	6.060
Forecourt	6.080
Maker Shopfront ¹¹	6.090
Shopfront	6.100
Terrace	6.110
Gallery	6.120
Allowed Public Frontage Types	Standards
Main Street	4.060.C.2

¹¹ Only on secondary front yard and not within 100' of street corner

9. Signage	
Allowed Sign Types	Standards
Projecting Sign	8.050
Awning/Canopy Sign	8.060
Wall Sign	8.070
Painted Wall Sign	8.080
Window Sign	8.090
Sidewalk Sign	8.100
Directory Sign	8.110

3.070 Adjacency Requirements

1. Where a proposed building in an ODS district is within the specified distance of the district(s) or land use(s) identified in Table 3.070.A, adjacency standards shall be applied to the building design to reduce its size in width, height, and volume. The area(s) removed after applying the adjacency standards is not allowed to be added elsewhere.
2. Where a proposed building in an ODS district is adjacent to a physical feature identified in Table 3.070.A, adjacency standards shall be applied to the design of habitable space abutting the feature.

Table 3.070.A: Adjacency Requirements

Applicability	Standard
<p>A Where abutting a residential use</p>	<p>Within 30' of shared property line: Max. 2.5 stories and 35' in overall height</p>
<p>B All building volumes within 30' of a single-family residential land use or a T3N.E or T4N.S district</p>	<p>Max. width per building volume: 50' Min. separation between building volumes: 20'</p>
<p>Where within 100' of a Creek</p>	<p>Ground floor frontage required, using the frontage types allowed by the district. Min. 15' building setback.</p>

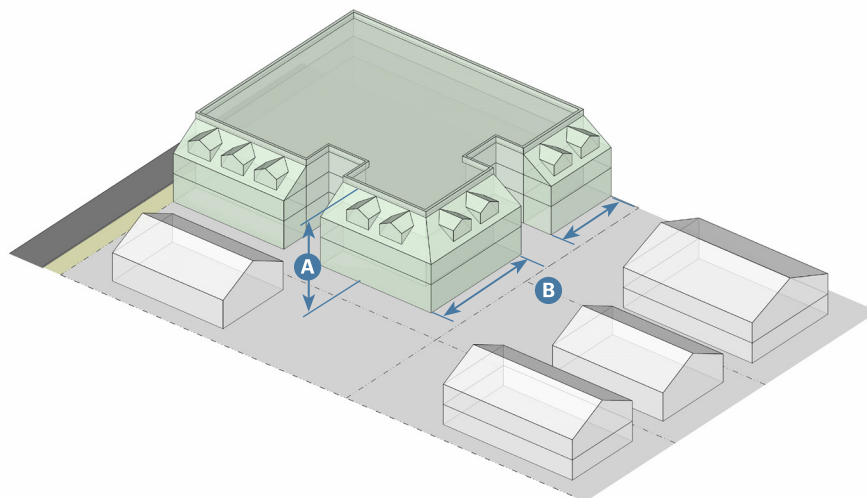

This page intentionally left blank

Chapter 4: General to Design Sites

Sections:

4.010	Purpose
4.020	Screening
4.030	Landscaping and Lighting
4.040	Parking and Loading
4.050	Slope Standards
4.060	Public Frontage Standards

4.010 Purpose

This Chapter provides standards to ensure that new development accomplishes the following:

1. Makes a positive contribution to the development pattern of the area;
2. New or altered structures are compatible with the design and use of existing structures on neighboring properties;
3. Respects the existing conditions of neighboring properties; and
4. Does not adversely affect neighboring properties, with "adversely affect" meaning to impact in a substantial, negative manner the habitability of these properties.

4.020 Screening

1. **Intent.** This Section provides standards for screening, fences, and walls for the protection of property, the enhancement of privacy, the attenuation of noise, and the improvement of the visual environment.
2. **Design Standards for Screening.** Except for wall- and ground-mounted equipment that is not visible from the public right-of-way or abutting design sites, all equipment shall comply with the following:
 - A. **Screening Height Maximums.** Screening shall not exceed the maximums identified in Table A (Maximum Screening Height).

Table 4.020.A: Maximum Screening Height					
District	Item	Maximum Height Allowed			
		Front	Side St.	Side	Rear
T3NE	Fences	3.5' max.	3.5' max.	8' max.	8' max.
	Free Standing Walls	3.5' max.	3.5' max.	8' max.	8' max.
	Landscaping ¹	3.5' max.	3.5' max.	8' max.	8' max.
T4N.S	Fences	3.5' max.	3.5' max.	8' max.	8' max.
	Free Standing Walls	3.5' max.	3.5' max.	8' max.	8' max.
	Landscaping ¹	3.5' max.	3.5' max.	8' max.	8' max.
T4MS.S, T4MS.M	Fences	---	---	8' max.	8' max.
	Free Standing Walls	---	---	8' max.	8' max.
	Landscaping ¹	3.5' max.	3.5' max.	8' max.	8' max.

¹Excludes trees

--- = Not Allowed

- B. **Screening Height Measurement.** Screening height shall be measured as the vertical distance between the finished grade at the base of the screen and the top edge of the screen material.
 - C. **Screening Opacity.** The first six feet measured from grade may be 100 percent opaque. Any screening greater than six feet up to the maximum allowed height shall have an opacity no greater than 50 percent.
 3. **Courtyard Screening**
 - A. Fences, walls and other screening installed to create a courtyard without a roof shall not exceed five feet in height and shall be set back a minimum of 10 feet from the front property line or back of sidewalk, whichever is the least.
 - B. Landscaping installed in compliance with Section 4.030 (Landscaping and Lighting).
 4. **Screening on Retaining Walls.** The total height of screens and the retaining walls they are mounted on or attached to shall not exceed six feet.

5. Mechanical Equipment Screening

- A. The following mechanical equipment is exempt from screening:
 - (1) Free-standing or roof-mounted solar equipment; and
 - (2) Vents less than two feet in height.
- B. For new installation or relocation of existing mechanical equipment, the equipment shall be screened.
 - (1) **Roof-Mounted Equipment.** Building parapets or other architectural elements in the building's architectural style shall screen roof-mounted equipment.
 - (a) New buildings shall be designed to provide a parapet or other architectural element that is as tall or taller than the highest point on any new mechanical equipment to be located on the roof of the building; and
 - (b) For existing buildings with no parapet less than two feet in height, mechanical equipment shall be surrounded on all sides by an opaque screen wall as tall as the highest point of the equipment. The wall shall be architecturally consistent with the building.
 - (2) **Wall- and Ground-Mounted Equipment**
 - (a) Equipment is not allowed between front or secondary front yard facades and the street.
 - (b) All screen devices shall be as high as the highest point of the equipment being screened.
 - (c) Equipment and screening shall be in compliance with the setbacks of the district.
 - (d) Screening shall be architecturally compatible and include matching paint, finish, and trim cap of the building.
 - (e) Plant materials, when used as a visual screen, shall consist of evergreen plants, planted in a minimum three-foot-wide planting strip. They shall be of a kind, or used in such a manner, so as to provide screening which meets the requirements in Section 4.030 (Landscaping and Lighting).
- 6. **Temporary Fencing.** Temporary fencing may be used to provide security for approved special events, construction sites, or vacant structures and land, which cannot otherwise be secured.
- 7. **Barbed Wire and Razor Wire.** Barbed wire and razor wire screening are not allowed.
- 8. **Safety.** Fences, walls, and other screening and landscaping, whether provided in compliance with the provisions of this Subsection or provided in addition to those provisions, are subject to review by the Traffic Engineer in the following areas to ensure that visibility is maintained:
 - A. Within 10 feet of the point of intersection of:
 - (1) A vehicular access way or driveway and a street; and/or
 - (2) A vehicular access way or driveway and a sidewalk.
 - B. Within 20 feet of the point of intersection of two or more vehicular access ways, including driveways, alleys, or streets.
 - C. As used in this Subsection, "point of intersection" is measured from the face of curb or if none, from the edge of pavement.

4.030 Landscaping and Lighting

1. **Intent.** This Section prescribes landscaping and lighting standards for protection and enhancement of the environmental and visual quality of the community, enhancement of privacy, and the control of dust.
2. **Required Landscaping.** The landscaping required by this Section shall be installed as part of the development or improvement(s) requiring the landscaping. Standards for landscaping in parking areas shall be in combination with Section 4.040 (Parking and Loading).
 - A. Landscaping materials shall be integrated into the required setbacks, stream and wetland buffers, and design of the selected private frontage type(s).
 - B. Landscape materials shall be applied to the planting areas identified for public frontage type(s).
3. **Required Lighting**
 - A. Site improvements, including lighting, shall be consistent with the selected Architectural Style for the primary building.
 - B. Lighting shall be provided in compliance with the following:
 - (1) All exterior lighting shall be designed, located, and lamped in order to prevent overlighting and light trespass.
 - (2) All parking lot lights shall be full cutoff luminaires, as certified by the manufacturer, with the light source directed downward and away from adjacent residences.
 - (3) Bollard lighting may be used to light walkways and other landscape features, but shall cast its light downward.
 - (4) Internally illuminated fascia, wall, roof, awning or other building parts are prohibited.
 - (5) All nonessential exterior lighting associated with non-residential uses shall be turned off within ½ hour after the close of business or when the non-residential use is not in use in all areas exempt Downtown. Exterior lighting in Downtown shall be turned off by 3:00 am.
4. **Design Standards**
 - A. **Allowed Landscaping Materials**
 - (1) Landscaping materials shall comply with the following:
 - (a) Shrubs, of at least one-gallon size;
 - (b) Ground cover instead of grass/turf; and/or
 - (c) Decorative nonliving landscaping materials including, but not limited to, sand, stone, gravel, wood or water may be used to satisfy a maximum of 25 percent of the required landscaping area.
 - (2) Street trees, of at least 15-gallon size, double-staked, planted between the curb and the back of the sidewalk.
 - B. **Species Selection**
 - (1) Native and drought tolerant species are required to meet the minimum standards, in conformance with Chapter 15.36 (Water Efficient Landscape Program).

- (2) Landscape selection shall include native vegetation, applicable to Sebastopol, in compliance with Chapter 15.36 (Water Efficient Landscape Program).
 - (3) Landscaping shall be in compliance with Chapter 15.36 (Water Efficient Landscape Program).
- C. **Existing Vegetation.** On-site protected native trees shall be incorporated into the landscape. See Section 8.12.040 (Definitions).
- D. **Retaining Walls**
- (1) Grading. Retaining walls shall comply with Section 4.050 (Slope Standards).
 - (2) Height.
 - (a) Retaining walls within the front street and/or secondary front yard façade zone(s) or visible from the public sidewalk adjoining the design site shall not exceed four feet as measured to the adjacent finished grade or sidewalk whichever is nearest.
 - (b) Retaining walls along the interior design site line that are beyond the front street and/or secondary front yard façade zone(s) shall not exceed three feet as measured to the adjacent finished grade.
 - (c) Retaining walls along the rear design site line that are beyond the front street and/or secondary front yard façade zone(s) shall not exceed eight feet as measured to the adjacent finished grade;
 - (3) Design Standards. All retaining walls shall:
 - (a) Comply with the building setbacks of the district; and
 - (b) Provide one-foot additional sidewalk width when retaining wall abuts front property line; and
 - (c) Include articulation, such as buttress or pilasters, if over 50 feet in length; and
 - (d) Include a landscape planter in front of the wall when not within the building. The planter shall be at least three feet deep measured perpendicular to the wall; and/or
 - (e) When not within the building, be finished with allowable wall material(s) of the selected architectural style for the primary building, or natural cut stone with matching mortar.
 - (4) Terraced Retaining Walls. Up to two terraced retaining walls are allowed, with a single retaining wall being no more than the maximum height allowed in Subsection (2) above, and in compliance with the following:
 - (a) Measure no more than 12 cumulative feet as measured from the lowest finished grade to the top of the upper wall for fill or cut slope retaining walls; and
 - (b) Have a minimum horizontal distance, as measured perpendicular to the walls, that is at least equal to the average height of the vertical walls; and
 - (c) Include landscape in the entire horizontal area between retaining walls.
- E. **Maintenance.** Required landscaping shall be maintained in a clean and healthy condition. This includes pruning, weeding, removal of litter, fertilizing, replacement of plants when necessary, and the appropriate watering of all landscaping.

4.040 Parking and Loading

1. **Intent.** This Section prescribes standards for motor vehicle and bicycle parking areas, loading and access drives, and standards for reducing motor vehicle trips per capita to and from development. These standards are intended to ensure that new development accomplishes the following:
 - A. Consistency with the intended physical character of walkable environments;
 - B. Provision of bicycle parking to increase bicycle trips and reduce motor vehicle trips per capita; and
 - C. Appropriately limits, screens, and landscapes motor vehicle parking areas to protect and enhance the environmental and visual quality of the community, enhance privacy, attenuate noise, and control dust.
2. **On-site parking.** On-site parking is allowed in all districts subject to the standards in this Section.
3. **Bicycle Parking Standards.** Bicycle parking shall be provided in compliance with the standards of the district.
4. **General Vehicular Parking Standards**
 - A. **Sharing of On-Site Parking.** Sharing of parking between different uses and developments is allowed.
 - B. **Sharing of Non-Residential Parking Required.** If on-site parking spaces for non-residential uses are provided, such spaces shall be made available for use by the general public during at least one of the following time periods:
 - (1) Monday through Friday, 8 AM to 5 PM; or
 - (2) Monday through Friday, 5 PM to 11 PM and all day on Saturday and Sunday.
 - C. ~~Larger Vehicle Parking~~
 - (1) ~~Trucks, tractors or tractor-trailers having a capacity of more than a 1.5-ton load, front- and rear-end loaders, or any kind of commercial, industrial, agricultural, or transportation vehicles/ equipment used primarily for business purposes, shall not be parked or stored in any district for purposes other than unloading, loading, or delivery services.~~
 - (2) ~~Automobiles, small trucks, vans, and vehicle trailers allowed in conjunction with an approved home occupation (one per home occupation), and recreational vehicles are excluded from the provisions of this Subsection.~~
 - D. **Storage of Unregistered or Inoperable Motor Vehicles.** Automotive vehicles, trailers, or vehicles of any kind or type, requiring licenses that are without current license plates or are inoperable shall only be parked within completely enclosed buildings.
 - E. **Cargo or Freight Container.** Portable cargo or freight storage containers in any district for purposes of loading or unloading may be parked or stored on-premise for a period not to exceed 10 days in any one calendar year.
5. **Number of Motor Vehicle Parking Spaces Required**
 - A. **Required Spaces.** See parking requirements in Section 17.110.020 (Off-street Parking Required).

Missed Edit:

Delete Subsection
4.040.4.C

6. **Parking Spaces, Design and Layout**

- A. **Parking Facilities.** If off-street parking is located within a carport or garage, it shall be designed in compliance with the selected Architectural style of the primary building.
- B. **Access.** On-site parking areas shall be accessed per the following:
 - (1) On-site parking shall be designed with an appropriate means of vehicular access to a street or to an alley to cause the least interference with traffic flow.
 - (2) Ingress to and egress from parking spaces shall be from an on-site aisle or driveway, directly from the front, secondary front yard, public alley, or rear lane.
 - (3) On-site loading space(s) is not required.
- C. **Driveways**
 - (1) Access to Driveways
 - (a) Driveway access to and from developments of two or fewer dwelling units onto public streets shall be by forward or reverse motion of the vehicle; and
 - (b) Driveway access to and from developments of three or more dwelling units onto public streets shall be by forward motion of the vehicle.
 - (c) Minimum 30 feet separation between driveways for all uses except developments of two or fewer dwelling units.
 - (2) Number of Driveways. Table A (Number of Driveways) specifies the maximum number of driveways for a development site.
 - (3) Driveways shall be setback from design site lines as follows:
 - (a) For front access, minimum two feet from side design site lines; and/or
 - (b) For secondary front yard access, no less than the minimum rear parking setback per the district; and/or
 - (c) Where driveway access is shared by abutting design sites, Subsections (a) and (b) above do not apply; minimum two feet from building(s), and in compliance with Subsection 17.110.010.I (Improvements).
 - (4) Driveways shall extend to and include the area between the design site line and the edge of the street pavement.
 - (5) The design and construction of all on-site parking access drives shall be in compliance with Subsection 17.110.010.I (Improvements).

Table 4.040.A: Number of Driveways	
Lot Frontage (Corner Parcel Applies Same Requirements as Secondary Front Yard)	Maximum Number of Driveways
Up to 150'	1
150' to 299'	2
Each additional 300' over 299'	1

- D. **Parking Techniques.** In compliance with Subsection 7 of the district, the following techniques may be applied individually or in combination:
- (1) **Tandem Parking.** Parking spaces are arranged in a series up to three spaces. Tandem parking is allowed in all districts for all uses.
 - (2) **Parking Court.** Parking spaces in groupings of covered or uncovered spaces or individual garages not in a podium configuration shared between two design sites. The maximum width of the parking court is 65 feet measured parallel to the adjacent street/right-of-way. The parking court is accessed from the adjacent street/right-of-way and the maximum width of the entrance to the parking court is determined by Subsection 7 of the district. See Figure 1 (Parking Court).
 - (3) **Podium Parking.** Parking spaces are located in an at-grade garage under the rear and/or interior side of the building or under all of the building except for the required ground floor habitable space. Occupiable space is along the edges of and/or above the garage level. The podium is not visible or exposed along the front and secondary front yard building facades.
 - (4) **Subterranean Parking.** Parking spaces are located below the adjacent finished grade of the building. The subterranean garage is allowed to be up to 5 feet above the adjacent finished grade of the building in compliance with the building form (Subsection 3 of the district) and frontage standards (Chapter 6).
 - (5) **Stacked Parking System.** Parking spaces are arranged in a system that provides two to three spaces in the horizontal area of one space. This type of system is within a podium parking garage.

Figure 4.040.1: Parking Court

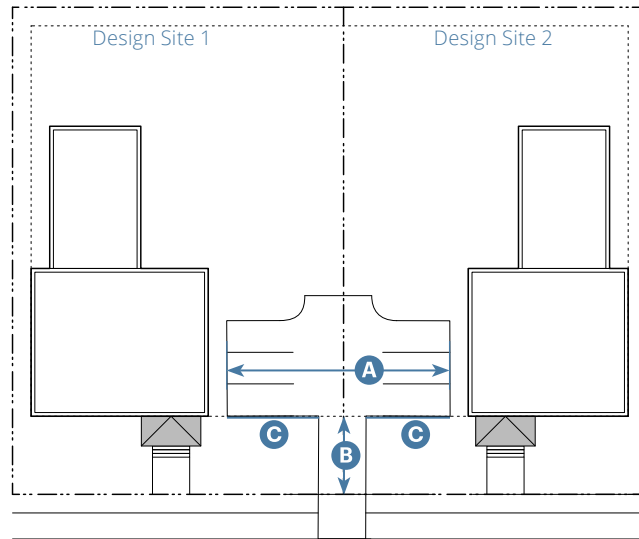

- -	Design Site Line		
----	Building Setback Line		
A	Width 65' max.		
B	Parking Court Setback:	Small Parking Court (6 or fewer spaces)	15' min.
		Large Parking Court (7 or more spaces)	Behind required ground floor habitable space required in Subsection 4 of the district
C	Decorative wall and landscaping	36" max. height in compliance with Section 4.030 (Landscaping and Lighting)	

- E. **Identification as to Purpose and Location.** On-site parking areas of four or more spaces shall include painted lines, wheel stops, or other methods of identifying individual parking spaces and loading areas, while distinguishing such spaces from aisle and other circulation features.

F. Materials

- (1) All on-site parking areas and driveways shall be surfaced only with materials identified in Chapter 17.110 (Off-street Parking Regulations).
- (2) Parking area surfacing materials shall consist of the following materials, in compliance with Chapter 17.110 (Off-street Parking Regulations):
 - (a) Gravel, crushed granite, "grasscrete";
 - (b) Recycled materials including, but not limited to, glass, rubber, used asphalt, brick, block and concrete; or
 - (c) A combination of the above materials.
- (3) A minimum of 20 percent of the parking area shall be improved with impervious materials, exclusive of required landscaping in Table E (Required Parking Lot Landscaping). See California Green Building Standards Code, Title 24.

G. Landscaping. The landscaping standards identified in Table B (Required Parking Lot Landscaping) shall be applied with the standards of Section 4.020 (Screening) and Section 4.030 (Landscaping and Lighting).

- (1) Parking and loading areas shall be screened from adjacent residential zones by a six foot wall, fence, or evergreen.
- (2) Screening is not required when parking area(s) is adjacent to an alley.
- (3) Landscaping areas shall integrate stormwater management features per Chapter 15.36 (Water Efficient Landscape Program).
- (4) For portions of parking areas covered by photo-voltaic solar collectors that also function as shade structures, the minimum standard for trees does not apply.

H. Location

- (1) Location of on-site parking is regulated by the required setbacks in Subsection 7 of the district and the following:
 - (a) Parking lots with 11-20 spaces shall be separated at least by five feet from buildings to make room for a sidewalk, landscaping, and/or other planting between the building and the parking area;
 - (b) Parking lots with more than 20 spaces shall be separated by at least 12 feet from buildings to make room for a sidewalk, landscaping, and other planting between the building and the parking area; and
 - (c) The required separation may be eliminated to the rear of buildings in areas designed for unloading and loading of materials.

Table 4.040.B: Required Parking Lot Landscaping

Number of Parking Spaces	Percent of Gross Parking Area Required to be Landscaped¹
10 or fewer	None
11 to 20	5' min. wide planter along property line
21 to 50	5%; 5' min. wide planter between every 5 spaces, property line, and building(s)
51 and over	10%; 5' min. wide planter between every 5 spaces, property line, and building(s)

General Landscaping

Perimeter Planter	5' wide min. or 10' wide min. if adjacent to a State highway
Required Border	6" high curb or equivalent
Border and Stormwater	Curb or equivalent shall include breaks every 4" to provide drainage to retention and filtration areas.
Car Overhangs	Shall be prevented by stops or curbs
Required Quantity	1 tree per every 5 parking spaces, beginning at 6 total spaces
Tree Well Size ²	5' min. in any direction
Tree Can Size	15 gallon min.
Tree Box Size	20% of required trees shall be 24" min.
Tree Caliper	1" min.
Tree Height at Installation	7' min. vertical clearance
Tree Characteristics	Tree canopy
Location	Evenly spaced throughout parking lot to provide uniform shade

¹Solar carports are allowed in lieu of required landscaping except for required perimeter planter. Carports and solar equipment shall be in compliance with the requirements.

²Any vehicle overhang requires the minimum planter area width to be expanded by an equivalent dimension.

- I. **Size of Parking Lot.** Parking lots larger than 10,000 square feet in size shall be broken down into smaller parking areas with planted landscape areas with a minimum width of 15 feet between them to minimize the perceived scale of the total field of stalls.

4.050 Slope Standards

1. **Intent.** This Section provides the standards for development in all districts on design sites with sloped topography. For the purposes of this Section, sloped topography is any slope of at least six percent.
 - A. Table A (Maximum Amount of Sloped Areas Allowed to be Developed) identifies the amount of developable area for sloped portions of design sites. This, in combination with the standards in this Section and the maximum allowed building footprint shall be applied to the design of the sloped portions of design sites.
 - B. Developments subject to Chapter 9 (Specific to Large Sites) requiring new streets shall be in compliance with maximum grade standards in Section 16.40.040 (Circulation).

Table 4.050.A: Maximum Amount of Sloped Areas Allowed to be Developed

Portions of Design Site with Existing Slope	Development Site ^{1,2}			Previously Developed >1 acre
	Greenfield			
	Up to 1 acre	1 to 3 acres	>3 acres	
0–5.99%	100% max.	100% max.	100% max.	No. to exceed previously developed footprint
6–9.99%	100% max.	70% max.	70% max.	
10–14.99%	100% max.	50% max.	25% max.	
15–19.99%	75% max.	25% max.	10% max.	
20–29.99%	25% max.	5% max.	0% max.	
> 30%	0% max.	0% max.	0% max.	

Missed Edit:
Deleted column "Previously Developed" in Table 4.050.A

¹ In compliance with the setbacks of the district, required on-site open space, this Section, and the maximum building footprint standards in Chapter 5 (Building Type Standards).

² In compliance with required amount of open space identified in Subsection 9.020.3.B.

2. **Building Height**
 - A. **Maximum Building Height.** Building height is regulated by Subsection 4 of the district. The maximum allowed height of a building shall follow the existing topography of the design site to ensure that each building is in compliance with the allowed building height.
 - (1) Figure 1 (Site Grading for Small-to-Medium Detached and Attached Building Forms) and Figure 2 (Site Grading for Large or Attached Building Forms) in this Section illustrate allowed and non-allowed site grading methods.
 - B. **Exposed Basements.** Basements do not count toward the maximum stories allowed in the district if exposed less than half of the basement's story height below the average adjacent finished grade.

3. **Topography and Required Location of Primary Building.** Sloped topography can present issues with locating the primary building on a design site in compliance with Subsection 5 of the district. Section 10.030 (Adjustments to Standards) identifies allowed administrative variations for issues arising from sloped topography, subject to the required findings in these Tables.
4. **Grading or Regrading of Design Sites.** When existing design site topography is proposed to be changed, grading shall not result in any of the following:
 - A. Creation of retaining walls or blank walls taller than four feet within required front or secondary front yard facade zones;
 - B. Retaining walls on side design site lines taller than three feet;
 - C. Retaining walls on rear design site lines not within the building footprint, taller than 10 feet;
 - D. Building(s) that do not reflect the existing topography of the design site;
 - E. Terraced design sites that result in a vertical difference of more than 4 feet between the adjacent right-of-way and the finished grade of the design site;
 - F. Grading beyond the building pad(s) and the required access drive(s);
 - G. Cut exceeding 16 feet in height from top to toe;
 - H. Cut slope exceeding two horizontal to one vertical;
 - I. Graded slopes exceeding 30%;
 - J. Graded slopes not contoured to blend with existing terrain, such that proposed cuts and fills exceed one foot of added/subtracted rise for each one and one-half feet of run;
 - K. Graded slopes not screened from view under or behind buildings with landscaping or natural topographic features; or
 - L. Graded slopes not revegetated with a mixture of grass seed or shrubs as identified by the USDA Soil Conservation Service.
 - M. Grading exceeding a total of 2,000 cubic yards per acre.
5. **Streets**
 - A. New roads, including parking access and drive aisles, shall not intrude into locations where slopes exceed 15%, or with identified seismic or geologic hazards, or within 50 feet of creek centerline, except where necessary to access a one-acre or larger developable area that would be otherwise inaccessible..
6. **Drainage Facilities.** All proposed drainage facilities shall preserve major drainage channels in their natural state and be designed in such a manner as to minimize soil erosion and to otherwise preserve the public health, safety, and welfare.

7. **Massing.** Buildings on sloped design sites shall reflect the existing topography of the design site.
 - A. Buildings with footprints 36 feet wide or less shall have a simple water table element or change in material between the basement and the ground floor.
 - B. Buildings with footprints wider than 36 feet and 2.5 stories or taller shall have a minimum of one story tall defined base. The base shall be defined through the use one of the following methods:
 - (1) Change in material;
 - (2) A continuous horizontal band between the base and upper floors; and/or.
 - (3) Use of a continuous shopfront frontage.
 - C. All design shall be in compliance with the selected style for the building(s) in Chapter 7 (Specific to Architectural Design).
8. **Frontage.** Along front and secondary front yard building facades, the primary building on each design site shall be designed in compliance with the standards for ground floor private frontage as required by Subsection 8 of the district.
9. **Administrative Relief.** Section 10.030 (Adjustments to Standards) provides for administrative variations from the standards in this Section due to topographic constraints.

This page intentionally left blank

Figure 4.050.1: Site Grading for Small-to-Medium Detached and Attached Building Forms

Allowed Site Grading. The following examples apply to the House, Duplex Side-by-Side, Cottage Court, Multiplex Small, Neighborhood Townhouse, Multiplex Medium, Pocket Neighborhood, and Neighborhood Courtyard Building Types.

Allowed. Grading that results in each new modified building stepping and reflecting the topography of the parcel or design sites, and that connects each building with the adjacent street and public realm.

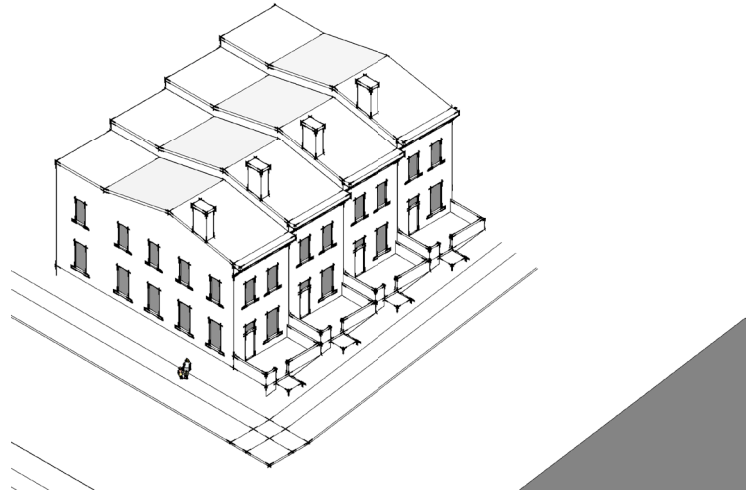
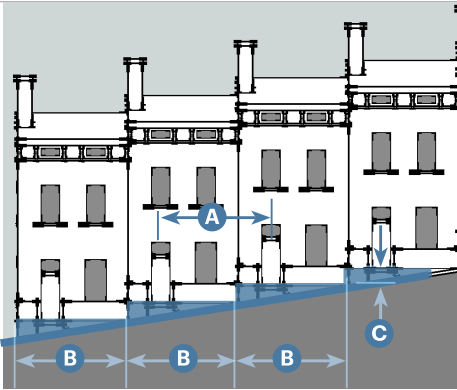

- Distance between building entries on slopes greater than 10% shall not exceed 50'. A
- Building footprint width steps with slope. B
- Finished grade of terraced design site is less than 4 feet from the adjacent street/right-of-way. C

Not Allowed. Grading that results in each new or modified building not following and reflecting the topography of the parcel or design sites, and disconnects each building from the adjacent street and public realm.

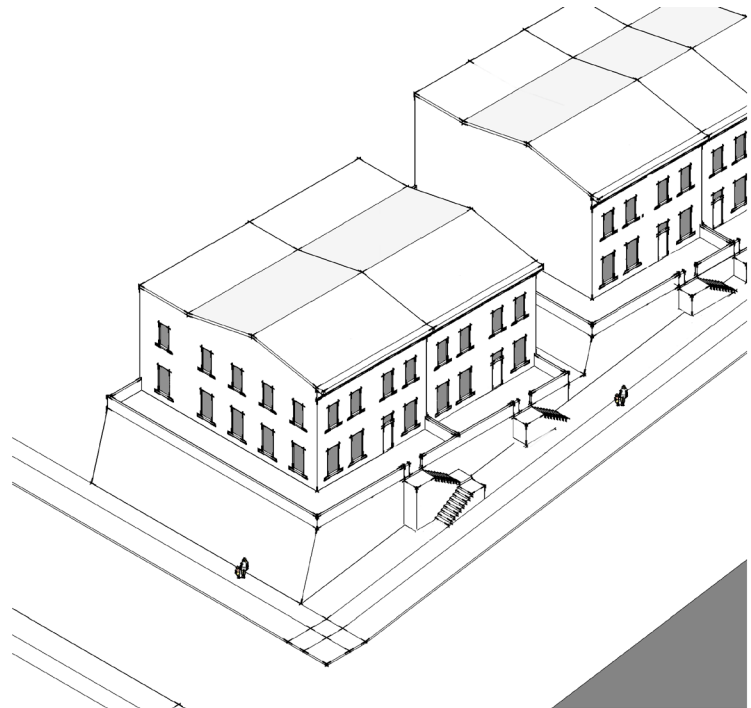
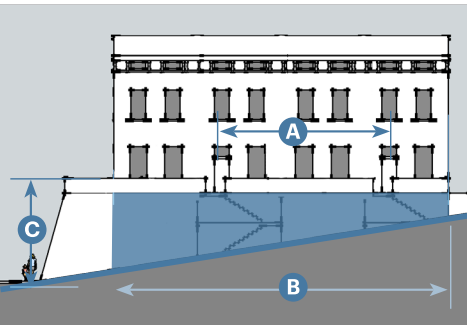

- Distance between building entries on slopes greater than 6% exceeds 50'. A
- Building footprint width does not step with slope. B
- Finished grade of terraced design site is more than 4 feet from the adjacent street/right-of-way. C

Figure 4.050.2: Site Grading for Large or Attached Building Forms

Allowed Site Grading. The following examples apply to the Core Townhouse, Core Courtyard, Multiplex Medium, and Main Street Building Types.

Allowed. Grading that results in each new or modified building fronting on the adjacent street(s), and that connects the building facades to the adjacent street and public realm, and avoids large blank retaining walls.

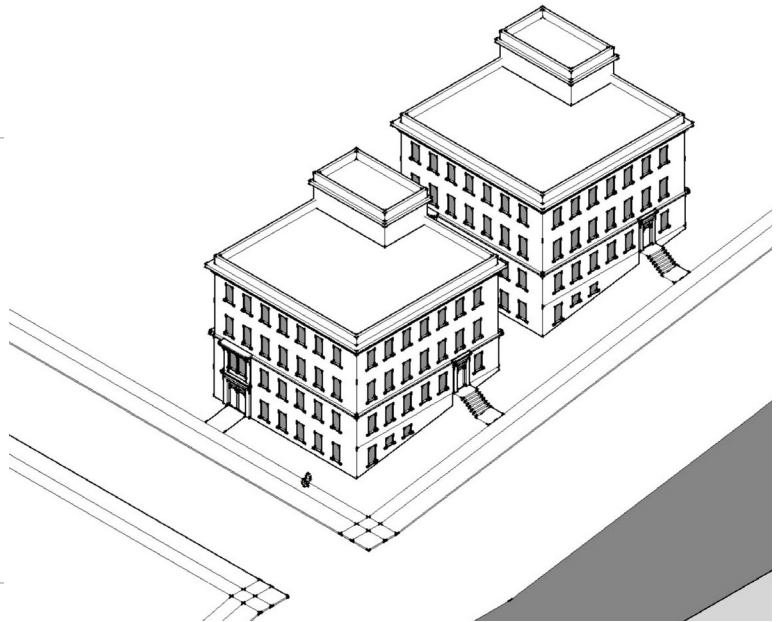
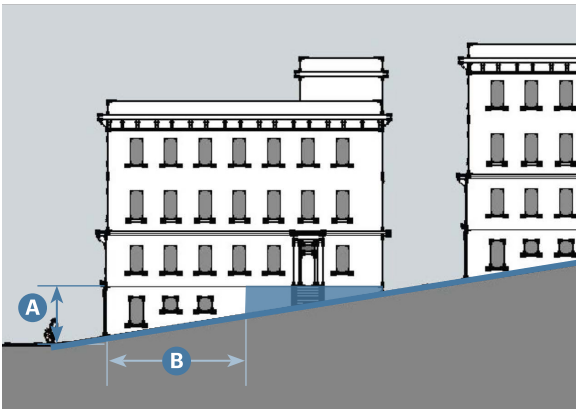

Slope is used to create a ground floor along street or open space. Finished grade of terraced design site is less than 4 feet from the adjacent street/right-of-way. **A**

Building footprint steps with slope through a partial ground story. **B**

Not Allowed. Grading that disconnects new and modified building facades from the adjacent public realm, and results in large retaining walls.

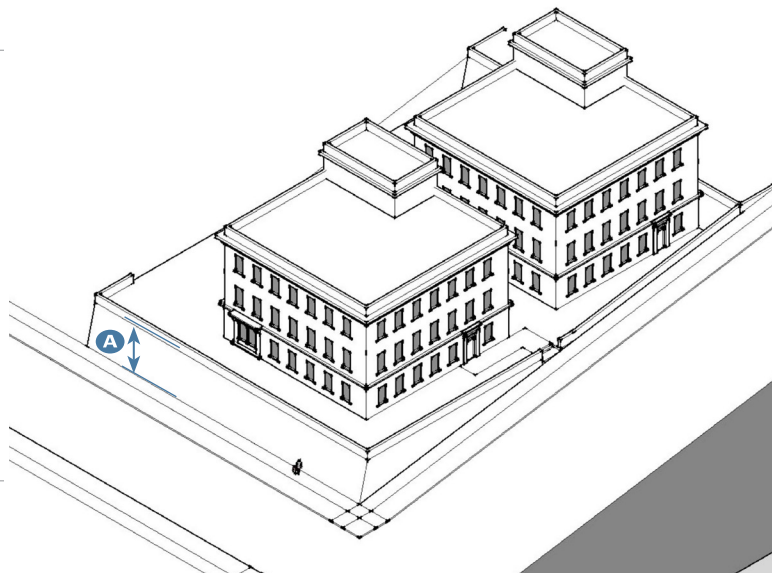
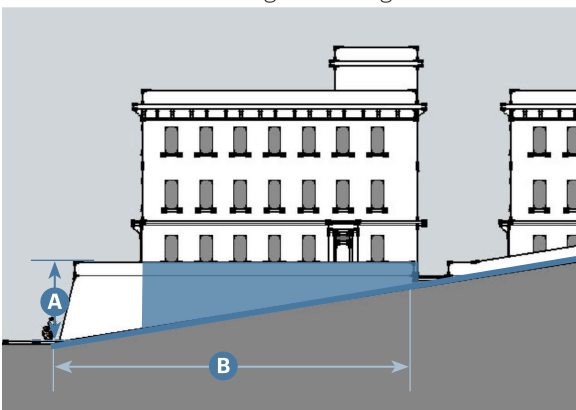

Height does not create building with frontage and entries along adjacent streets; terraced design site is more than 4 feet from adjacent sidewalk/street/right-of-way. **A**

Building footprint does not step with slope. **B**

4.060 Public Frontage Standards

1. **Intent.** Public frontage types provide a coordinated approach to design standards for the area between each design site's private frontage(s) and the adjoining right-of-way or private driveway easement. Public frontage types consist of planters, walkways, curbs, planters, planting and lighting, as illustrated in Table B (Public Frontage Types Overview).
2. **Required Improvements.** The public frontage along the design site(s) shall be improved per Table A (Required Improvements) and the development scenario that applies to the project.

Table 4.060.A: Required Improvements

Required Improvements	Development Scenario			
	Infill Design Site on Existing Block	Two or More Design Sites on Existing Block	More Than Half of Existing Block	New Block(s)
	Development consists of one design site.	Development consists of two or more design sites that are less than half of the block face.	Development consists of two or more design sites that are more than half of the block face.	Development creates one or more new blocks.
a. Sidewalk. Add missing segment(s) along abutting front street and/or secondary front yard.	R	R	R	R
b. Sidewalk. Repair uneven segments along abutting front street and/or secondary front yard.	R	R	R	N/A
c. Street trees. Add street trees along abutting front street and/or secondary front yard where there is adequate room to also maintain sufficient width for traffic lanes, pedestrian sidewalks, and bicycle facilities.	R	R	R	R
d. Crosswalk improvements. Add crosswalk as needed to maintain pre-project Pedestrian Level of Traffic Stress (PLTS).	---	---	---	R [Including adjacent and new intersection(s)]
e. Bicycle facilities. Add bicycle facilities required in the Bicycle and Pedestrian Master Plan.	---	---	R	R [Including bike lanes]
f. Curb and Gutter. Replace broken and damaged curb and gutter.	R	R	R	N/A

Key R = Required --- = Not Required

3. **Design Standards for Public Frontages.** Public frontages shall be designed and maintained in compliance with the following standards:
 - A. For new streets or new blocks, the required elements are identified in and shall be configured according to Table C (Public Frontage Assemblies) and in compliance with Section 16.40.040 (Circulation).
 - B. For infill projects, the required elements shall be configured consistent with those existing on immediately adjacent parcels, along the subject parcel's front street and secondary front yard frontage. Where the configuration differs on adjacent parcels, the design site shall transition dimensions of required elements between those existing on adjacent parcels.
 - C. Planting and landscape selection shall be in compliance with Chapter 15.36 (Water Efficient Landscape Program).
4. **Pedestrian Crossings**
 - A. **Curb Ramps.** Perpendicular corner curb ramps with a separate ramp installed in each direction are required.
 - B. **Crosswalks.** Crosswalks shall be designed per the Sebastopol's applicable standards and applicable State guidelines and standards.
 - (1) Standard Crosswalk.

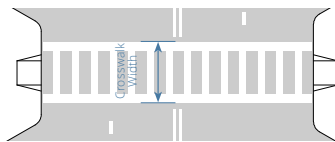

5. **Allowed Public Frontage Types**
 - A. **Neighborhood Street.** The Street Frontage includes raised curbs drained by inlets with sidewalks separated from vehicular lanes by individual or continuous planters. Landscaping consists of street trees of a single or alternating species aligned and spaced at 35' intervals on average.
 - B. **Main Street.** The Main Street Frontage includes raised curbs drained by inlets with very wide sidewalks along both sides separated from the vehicular lanes by individual tree wells with grates. Landscaping consists of a single tree species aligned and spaced at 35' intervals on average.

Table 4.060.B: Public Frontage Types Overview

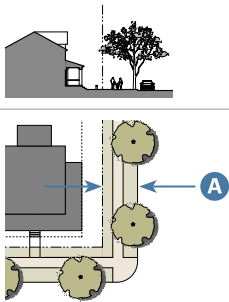
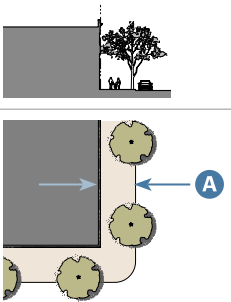

Table B (Public Frontage Types Overview) provides an overview of the allowed public frontage types in or abutting each district.

Public Frontage Types	Specific Standards	Districts			
		T3		T4	
		NE	N.S	MS.S	MS.M
Neighborhood Street	4.060.C.1	P	P	---	---
Main Street	4.060.C.2	---	---	P	P

Key P = Allowed --- = Not Allowed

Table 4.060.C: Public Frontage Assemblies

Table C (Public Frontage Assemblies) identifies the required elements and dimensions of each public frontage type.

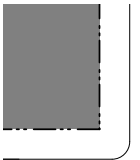
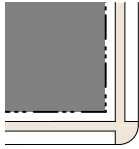
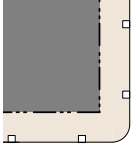
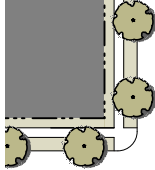
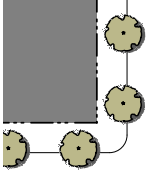
	Neighborhood Street 4.060.C.1	Main Street 4.060.C.2
Assembly. The type and dimension of curbs, walkways, and planters.		
Total Width	A 11' min.	A 16' min.
Note: See below for required elements of each assembly		
a. Curb. The detailing of the edge of the vehicular pavement, incorporating drainage.		
i. Type	Raised Curb	Raised Curb
b. Walkway. The pavement dedicated exclusively to pedestrian activity.		
i. Type	Walkway	Walkway
ii. Width	6' min.	12' min.
Note: Placement of curb ramps shall match the desired path of pedestrian travel. See Resolution No. 6371-2021 (Street Standards) for curb ramp design.		
c. Planter. The area that accommodates street trees and other landscaping.		
Arrangement	Regular	Regular
Types	Planting Strips along curb edge and R.O.W. edge	Tree Wells (must be located between walkway and curb)
Width	5' min.	4' min.

Chapter 5: Specific to Building Types

Sections:

5.010	Purpose
5.020	Building Types
5.030	Overview of Building Types
5.040	House
5.050	Duplex Side-by-Side
5.060	Cottage Court
5.070	Multiplex Small
5.080	Neighborhood Townhouse
5.090	Side Court
5.100	Neighborhood Courtyard
5.110	Pocket Neighborhood
5.120	Multiplex Medium
5.130	Core Townhouse
5.140	Core Courtyard
5.150	Main Street Building
5.160	Massing Compositions

5.010 Purpose

This Chapter provides the standards for development of individual building types to achieve the intended physical character of each district, offer housing choices and affordable housing opportunities, and incubate small businesses as amenities within walkable neighborhoods.

5.020 Building Types

1. Building types are used to articulate size, scale, and intensity according to the intent of each district.
2. Building types are categorized into two groups: House-Scale Buildings and Block-Scale Buildings. See Figure 1 (Example of House-Scale and Block-Scale Buildings) for examples.
 - A. **House-Scale Buildings.** Buildings that are the size of a house, typically ranging in footprint from as small as 25 feet up to 80 feet overall; and
 - B. **Block-Scale Buildings.** Buildings that are individually as large as most or all of a block or, when arranged together along a street, appear as long as most or all of a block.

3. Design sites are used to achieve pedestrian-scaled buildings. Each design site shall have only one primary building type, except as follows, and in compliance with all standards:
 - A. The Cottage Court (Section 5.080) may consist of up to nine individual buildings;
 - B. The Pocket Neighborhood (Section 5.120) may consist of up to 10 individual buildings; and
 - C. The Core Courtyard (Section 5.150) may consist of up to two buildings.
4. In T4NS-O, T4MS.S and T4MS.M, detached buildings are allowed to be connected in compliance with the following:
 - A. The connection is at least 30 feet behind the building façade nearest to the street;
 - B. The area of connection is at least 15 feet and up to 30 feet wide;
 - C. The building façade nearest to the street is in compliance with the required façade zone;
 - D. Upper story connections are at least 10 feet above the finished grade of the building and at least 13 feet, 6 inches above if the area below accommodates vehicle access.
5. On-site open space. The standards identify only the required type (private or common) and amount. For example, if the type only has standards for private open space, common open space is not required for that building type. The identified amount is for the entire building unless specified otherwise.
6. Parking may be designed as tuck-under, detached garage(s), podium or subterranean, in compliance with the district standards for parking placement.
7. Wings are allowed for certain building types to allow an increase in building square footage without increasing the maximum allowed footprint of the main body.
 - A. Wings are required to be smaller in footprint, one story less and 10 feet less to highest eave/parapet than the main body to visually reduce the overall size of a building.
 - B. The building type standards specify the amount that wings are required to be offset from the main body so that their facades are not aligned.
 - C. Wing offset from Main Body required only on facades along Front, Secondary Front Yard, or Open Space.
8. The maximum number of units identified for each building type is dependent on the design site being large enough to accommodate the district's standards (e.g., parking).
9. Individual designs may vary from the diagrams for each building type in compliance with the standards of this Chapter and Chapter 7 (Specific to Architectural Design).
10. New buildings and their improvements are subject to Sebastopol's local standards for Fire Safety and Building Safety.

Figure 5.020.1 Example of House-Scale and Block-Scale Buildings

House-Scale Buildings

Main body only

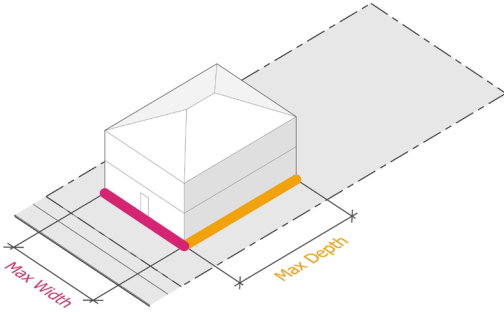

Main body only

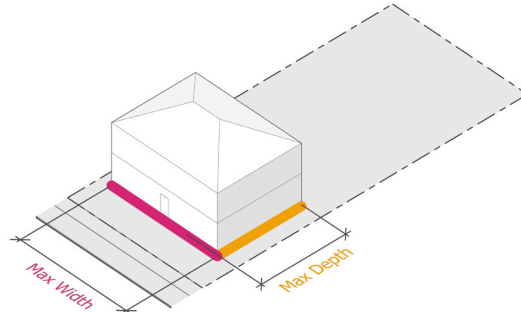

Main body with side and rear wings

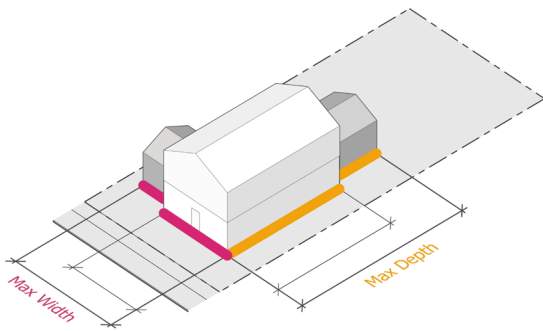

Main body with rear wing

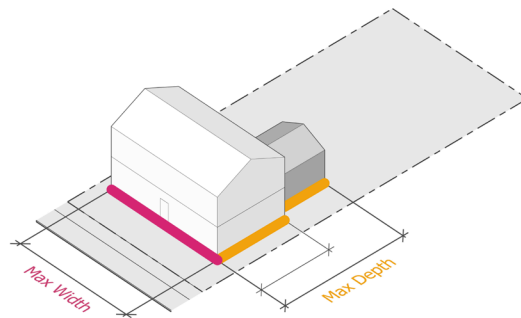

Block-Scale Buildings

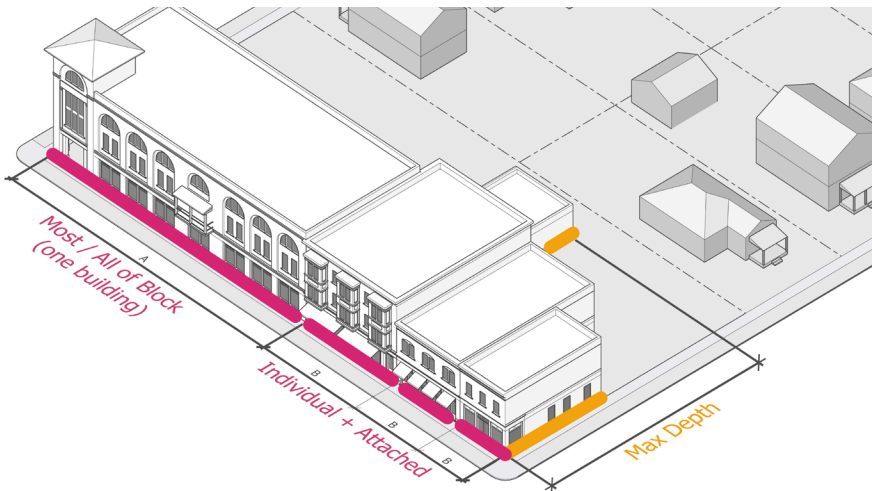

5.030 Overview of Building Types

Table A (Building Types Overview) provides an overview of the allowed building types in each district. The names of the building types are not intended to limit uses within a building type. For example, a Duplex may have non-residential uses within it as allowed by the district.

Table 5.030.A: Building Types Overview					
	Specific Standards	Districts			
		T3	T4		
		NE	N.S	MS.S	MS.M
House Scale					
House	5.050	P	P	P	---
Duplex Side-by-Side	5.060	P	P	---	---
Cottage Court	5.070	P	P	P	---
Multiplex Small	5.080	P	P	P	---
Neighborhood Townhouse	5.090	P	P	P	---
Side Court	5.100	P	P	---	---
Neighborhood Courtyard	5.110	P	P	P	---
Pocket Neighborhood	5.120	P	P	---	---
Multiplex Medium	5.130	---	P	P	P
Block Scale					
Core Townhouse	5.140	---	---	---	P
Core Courtyard	5.150	---	---	---	P
Main Street Building	5.160	---	O	P	P

Key P = Allowed --- = Not Allowed O = Open Sub-District Only

This page intentionally left blank

5.040 House



Example of House



Example of House



Example of House

1. Description

A small-to-medium-sized, detached, House-Scale Building with one unit, small-to-medium setbacks, a rear setback, and located within a low-intensity, walkable neighborhood.

2. Number of Units

Units per Building	1 max.
Buildings per Design Site	1 max. ¹

¹ Not including ADU

General Note: Photos on this page are illustrative, not regulatory.

Alley access required if alley exists

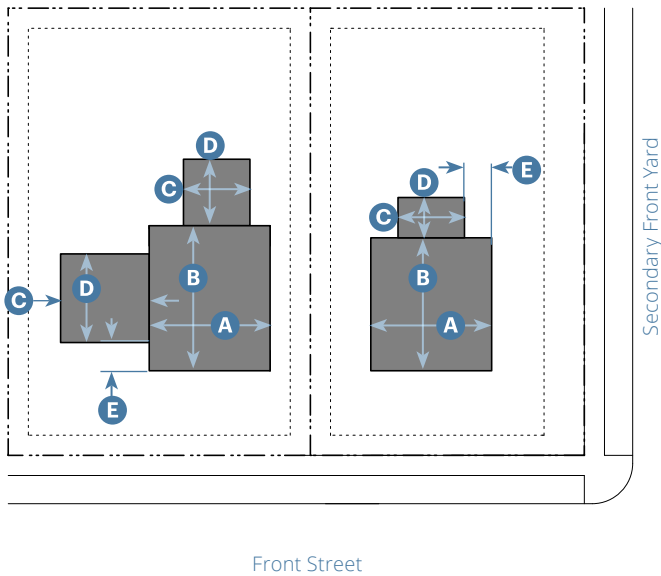

Alley access required if alley exists

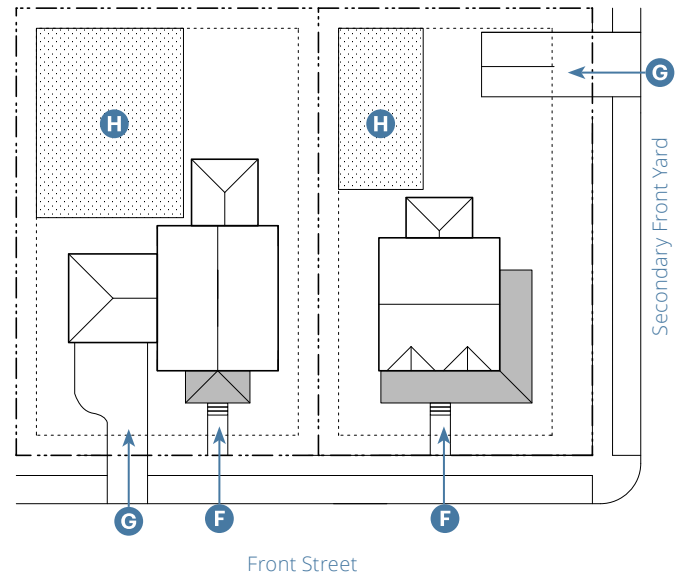

Key

- ROW/ Design Site Line
- Building Setback Line
- Building

3. Building Size and Massing

Height

Stories 2.5 max.

Main Body²

Width 36' max. **(A)**

Depth 48' max. **(B)**

Wing(s)²

Width 20' max. **(C)**

Depth 20' max. **(D)**

Separation between Wings on Same Facade 15' min.

Offset from Main Body 5' min. **(E)**

Massing Types

Sloped Roof Box	Subsection 5.160.1.A
Sloped Roof Bar	Subsection 5.160.1.B
Sloped Roof L	Subsection 5.160.1.C

²In compliance with Subsection 5 of the district.

Key

- ROW/ Design Site Line
- Building Setback Line
- Frontage
- ▨ Private Open Space

4. Pedestrian Access

Main Entrance Location Front Street **(F)**

5. Vehicle Access and Parking

Driveway and parking location shall comply with standards in Subsection 7 of the district. **(G)**

Parking may be covered, uncovered, or in a garage.

6. Open Space

Private Open Space

Area 300 sf min. **(H)**

Required setbacks and driveways do not count toward open space.

Required private open space shall be located behind the main body of the building.

5.050 Duplex Side-by-Side



Example of Duplex Side-by-Side



Example of Duplex Side-by-Side



Example of Duplex Side-by-Side

1. Description

A small-to-medium-sized, detached, House-Scale Building with small-to-medium setbacks and a rear setback. The building consists of two side-by-side units, both facing the street and within a single Building massing. The type has the appearance of a medium-to-large, single-unit house and is scaled to fit within lower-intensity neighborhoods.

2. Number of Units

Units per Building	2 max.
Buildings per Design Site	1 max.

General Note: Photos on this page are illustrative, not regulatory.

Alley access required if alley exists

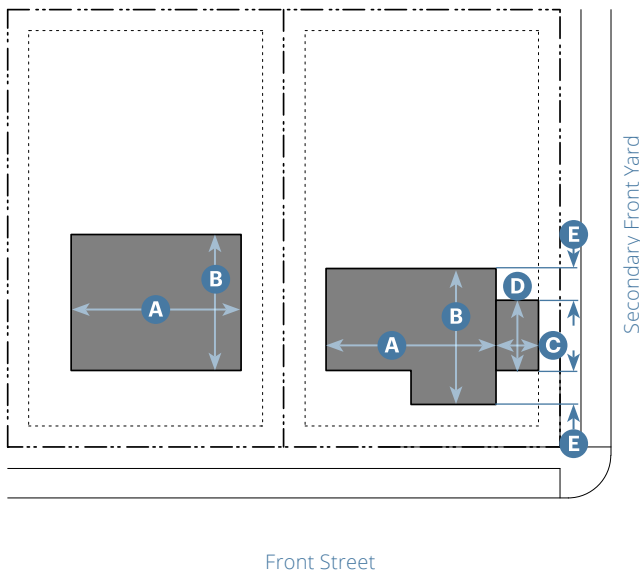

Alley access required if alley exists

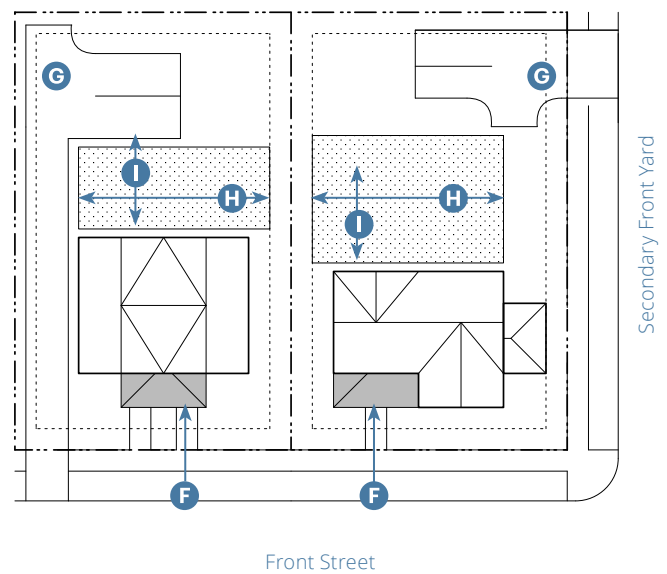

Key

- - - - ROW/ Design Site Line
- Building Setback Line
- Building

3. Building Size and Massing

Height	
Stories	2.5 max.
Main Body ¹	
Width	48' max. (A)
Depth	36' max. (B)
Wing(s) ¹	
Width	15' max. (C)
Depth	24' max. (D)
Separation between Wings on Same Facade	15' min.
Offset from Main Body	5' min. (E)
Massing Types	
Sloped Roof Bar	Subsection 5.160.1.B
Sloped Roof L	Subsection 5.160.1.C
Sloped Roof Forecourt	Subsection 5.160.1.E

¹ In compliance with Subsection 5 of the district.

Key

- - - - ROW/ Design Site Line
- Building Setback Line
- Frontage
- ▨ Private Open Space

4. Pedestrian Access

Main Entrance Location Front Street² **(F)**

Each unit shall have an entry facing the street on or within 15' of the front facade.

² On corner design sites, each unit shall front a different street.

5. Vehicle Access and Parking

Driveway and parking location shall comply with standards in Subsection 7 of the district. **(G)**

Parking may be covered, uncovered, or in a garage.

6. Open Space

Common Open Space	
Width	15' min. (H)
Depth	15' min. (I)

Required setbacks and driveways do not count toward open space.

Required private open space shall be located behind the main body of the building.

5.060 Cottage Court



Example of Cottage Court



Example of Cottage Court



Example of Cottage Court

1. Description

A group of up to nine small, detached, House-Scale Buildings arranged to define a shared court open to and visible from the street. The shared court is common open space and takes the place of a private rear setback, thus becoming an important community-enhancing element. The type is scaled to fit within low-to-moderate-intensity neighborhoods and in non-residential contexts.

Synonym: Bungalow Court

2. Number of Units

Units per Building	1 max.
Buildings per Design Site	3 min.; 9 max. ¹

¹ In the T3NE and T4N.S districts, the rearmost Cottage may contain up to 2 units, for a total of 10 units.

General Note: Photos on this page are illustrative, not regulatory.

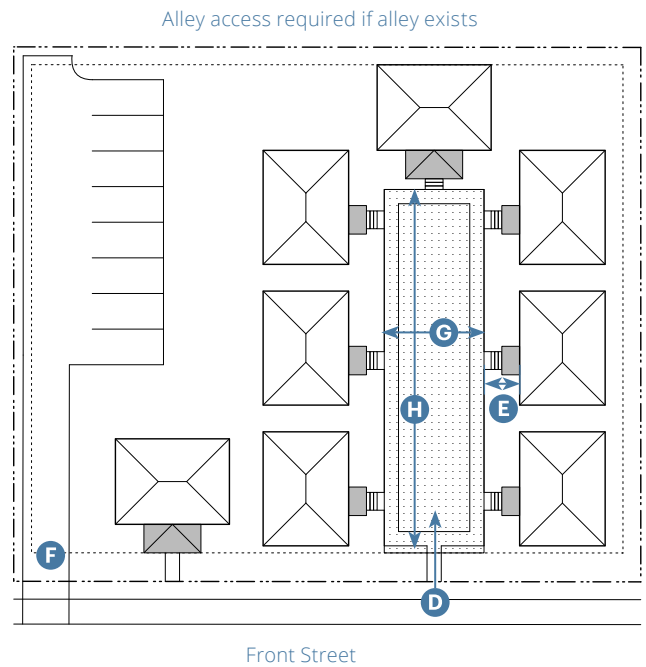
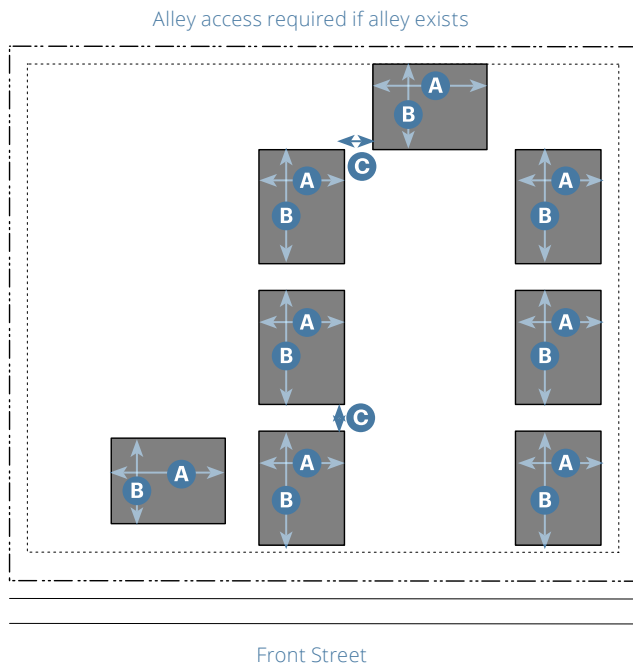

Key

- ROW/ Design Site Line ■ Building
- Building Setback Line

3. Building Size and Massing

Height

Stories	1.5 max.
To Highest Eave/parapet	18' max.

Main Body (per Cottage)²

Width	32' max.	(A)
Depth	32' max.	(B)
Separation between Cottages	7' min.	(C)

Wing(s)

Not Allowed

Massing Types (per Cottage)

Sloped Roof Box	Subsection 5.160.1.A
Sloped Roof L	Subsection 5.160.1.C

4. Pedestrian Access

Shared court shall be accessible from front street. (D)

Pedestrian Path Setbacks

From Building Entrance	6' min.	(E)
------------------------	---------	-----

Main entrance to units required from shared court.

Units on a corner may enter from the secondary front yard.

Pedestrian connections shall connect all buildings to the public ROW, shared court, and parking areas.

²In compliance with Subsection 5 of the district.

Key

- ROW/ Design Site Line ■ Frontage
- Building Setback Line □ Common Open Space

5. Vehicle Access and Parking

Driveway and parking location shall comply with standards in Subsection 7 of the district. (F)

Parking may be covered, uncovered, or in a garage.

Spaces may be individually accessible by the units and/or common parking area(s) at rear or side of design site.

6. Open Space

Common Open Space

Width	20' min. clear	(G)
Depth	75' min. (3-4 units)	(H)
	90' min. (5-9 units)	

Required setbacks and driveways do not count as open space.

Up to 1/3 of the shared court(s) may be used for stormwater management if designed as a rain garden or bioswale.

7. Miscellaneous

Fencing

Fencing only allowed around or between individual buildings and shall not exceed 36" in height.

Visibility shall be maintained through the fencing.

5.070 Multiplex Small



Example of Multiplex Small



Example of Multiplex Small



Example of Multiplex Small

1. Description

A small-sized, detached, House-Scale Building that consists of two to four attached and/or stacked units, typically with one shared entry or individual entries along the front. The type has the appearance of a medium-sized, single-unit house and is scaled to fit within low- to moderate-intensity neighborhoods.

2. Number of Units

Units per Building	2 min.; 4 max.
Buildings per Design Site	1 max.

General Note: Photos on this page are illustrative, not regulatory.

Alley access required if alley exists

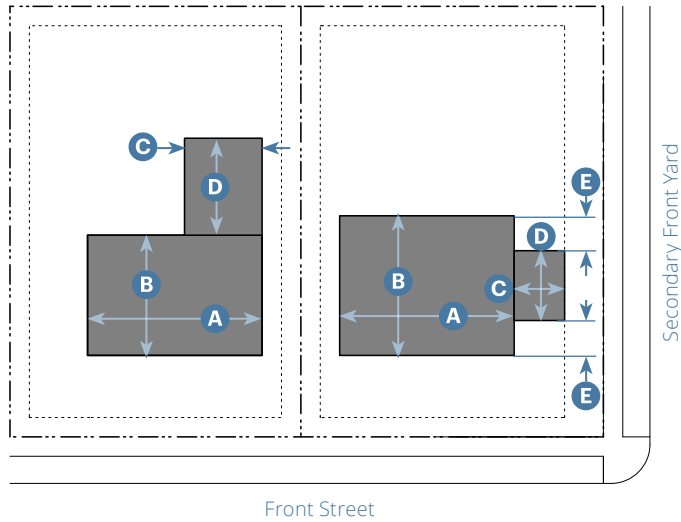

Alley access required if alley exists

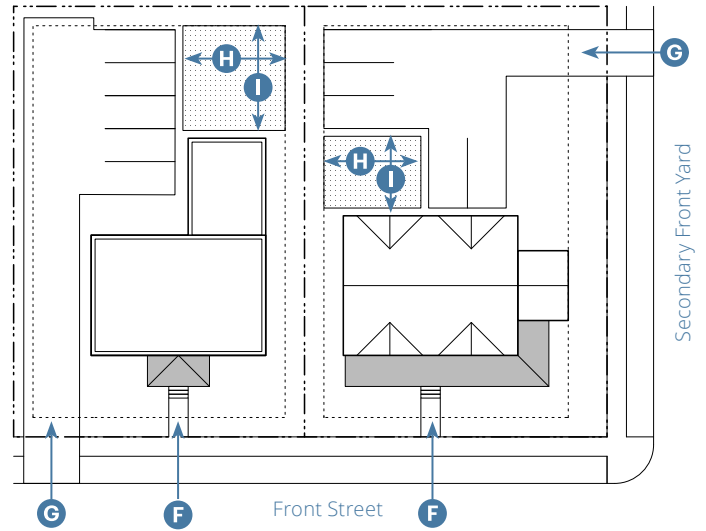

Key

- - - - ROW/ Design Site Line
- Building Setback Line
- Building

3. Building Size and Massing

Height

Stories 2.5 max.

Main Body¹

Width 48' max. **A**

Depth 48' max. **B**

Wing(s)¹

Width 15' max. **C**

Depth 20' max. **D**

Separation between Wings on Same Facade 15' min.

Offset from Main Body 5' min. **E**

Massing Types

Sloped Roof Box	Subsection 5.160.1.A
Sloped Roof Bar	Subsection 5.160.1.B
Sloped Roof L	Subsection 5.160.1.C
Sloped Roof Forecourt	Subsection 5.160.1.E

¹ In compliance with Subsection 5 of the district.

Key

- - - - ROW/ Design Site Line
- Building Setback Line
- Frontage
- Common Open Space

4. Pedestrian Access

Main Entrance Location Front Street **F**

Each unit may have an individual entry.

5. Vehicle Access and Parking

Driveway and parking location shall comply with standards in Subsection 7 of the district. **G**

Parking may be covered, uncovered, or in a garage.

6. Open Space

Common Open Space²

Width 15' min. **H**

Depth 15' min. **I**

Required setbacks and driveways do not count toward open space.

Required common open space shall be located behind the main body of the building.

² None is required if the building is within 800' of open space.

5.080 Neighborhood Townhouse



Example of Neighborhood Townhouse



Example of Neighborhood Townhouse



Example of Neighborhood Townhouse

1. Description

A small-sized, typically attached, House-Scale Building (up to four units side-by-side) with a rear setback. Each Neighborhood Townhouse consists of one unit. As allowed by the district, the type may also be detached with minimal separations between buildings. The type is typically located within low-to-moderate-intensity neighborhoods.

Synonym: Rowhouse

2. Number of Units

Units per Building	1 max. (up to 4 side-by-side)
Buildings per Design Site	1 max.

General Note: Photos on this page are illustrative, not regulatory.

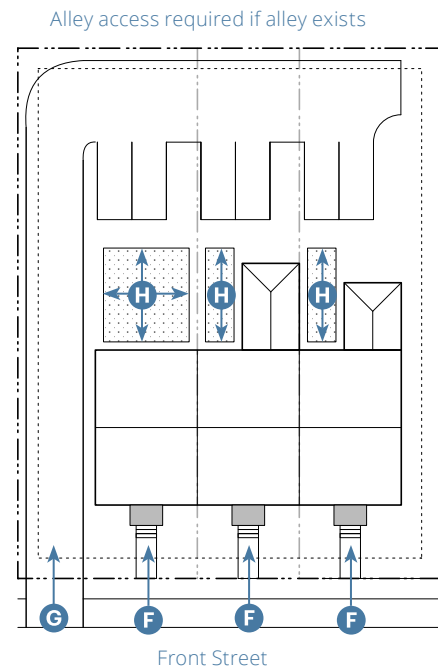
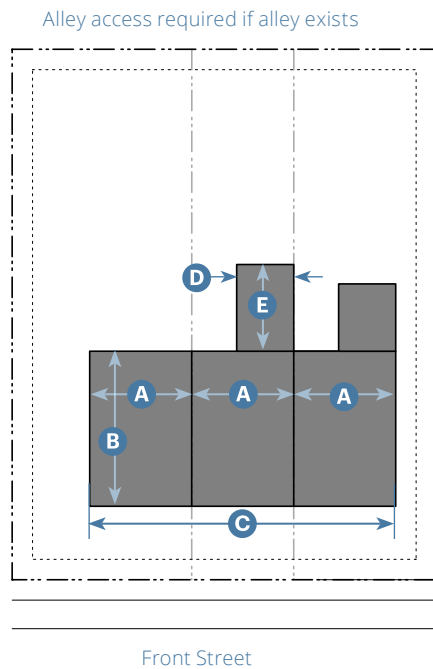

Key

- - - - ROW/ Design Site Line
- Building Setback Line
- Building

3. Building Size and Massing

Height	T3NE	T4N.S T4MS.S
--------	------	-----------------

Stories — 2.5 max. —

Main Body (per Townhouse)¹

Width per Unit 24' min.; 18' min. **A**
30' max.

Depth per Unit — 40' max. — **B**

Width per Building 100' max. 120' max. **C**

Wing(s)¹

Width — 14' max. — **D**

Depth — 25' max. — **E**

Separation between Wings on — 15' min. —

Same Facade

Massing Types (per Run)

Sloped Roof Bar	Subsection 5.160.1.B
Sloped Roof T	Subsection 5.160.1.D
Sloped Roof Forecourt	Subsection 5.160.1.E

¹ In compliance with Subsection 5 of the district.

Key

- - - - ROW/ Design Site Line
- Building Setback Line
- Frontage
- ▨ Private Open Space

4. Pedestrian Access

Main Entrance Location Front Street **F**

Each unit shall have an individual entry facing a street.

5. Vehicle Access and Parking

Driveway and parking location shall comply with standards in Subsection 7 of the district. **G**

Parking may be covered, uncovered, or in a garage.

6. Open Space

Private Open Space

Width 8' min. **H**

Depth 8' min. **H**

Required setbacks and driveways do not count toward open space.

Required private open space shall be located behind the main body of the building.

5.090 Side Court



Example of a Side Court (image source: Google)



Example of a Side Court (Image source: Google)



Example of a Side Court (image source: Realtor.com)

1. Description

A series of house-scale buildings fronting a shared "parking court" that doubles as a driveway and outdoor space for the units. The foremost building faces the street and the shared court; the rearmost building is parallel with the rear parcel line. This type is intended for narrow and deep mid-block parcels and is typically located within low-to-moderate-intensity neighborhoods.

2. Number of Units

Units per Design Site	As allowed by General Plan maximum density
-----------------------	--

Buildings per Design Site	3 max.
---------------------------	--------

General Note: Photos on this page are illustrative, not regulatory.

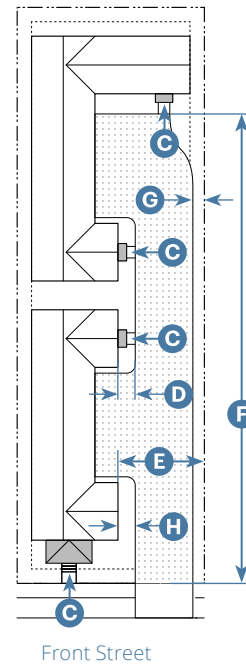
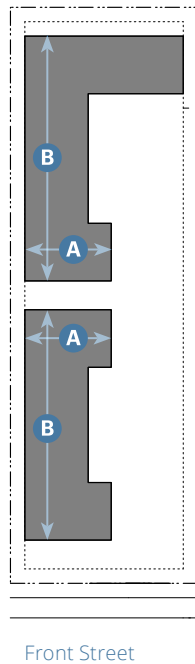

Key

- - - - ROW/ Design Site Line
- Building Setback Line
- Building

3. Building Size and Massing

Height

Stories 2.5 max.

Main Body (per Building)¹

Width 48' max.² **A**

Overall Length 85' max. **B**

Massing Types (per Building)

Sloped Roof Box	Subsection 5.160.1.A
Sloped Roof L	Subsection 5.160.1.C
Sloped Roof Forecourt	Subsection 5.160.1.E
Sloped Roof L Courtyard	Subsection 5.160.1.F

Façades shall be designed in compliance with Chapter 7 (Specific to Architectural Design).

At least 50% of ground floor space shall be habitable. Habitable space shall not include garage or parking.

4. Pedestrian Access

The frontmost unit shall be accessed from the street; **C**
 other units shall be accessed from the parking court.
 Each primary entrance shall include a frontage type, as **D**
 allowed in Table 6.030.A, within an area at least 7' deep.

¹ In compliance with Subsection 5 of the district.

² No max. within 50' of rear design site line.

Key

- - - - ROW/ Design Site Line
- Building Setback Line
- Frontage
- ▨ Parking Court

5. Vehicle Access and Parking

Driveway and parking location shall comply with standards in Subsection 7 of the district.

Parking Court

Width 26' min. (building façade to property line) **E**

Depth Up to rearmost building, in compliance **F**
 with fire access requirements.

6. Open Space

Landscaping

The area between the parking court pavement and the **G**
 property line shall be landscaped, averaging at least 4
 feet in width along the length of the parking court.

The area between all habitable space and the parking **H**
 court pavement shall be landscaped, averaging at least 2
 feet in width along each façade.

Paving

Parking court surface may be stamped concrete, pavers,
 brick, and/or grasscrete. No more than 20% of the surface
 area may be asphalt or untextured poured concrete.
 The edges of the parking court pavement shall not be
 composed exclusively of straight lines.

5.100 Neighborhood Courtyard



Example of Neighborhood Courtyard



Example of Neighborhood Courtyard



Example of Neighborhood Courtyard

1. Description

A detached, House-Scale Building that consists of multiple attached and/or stacked units, accessed from a shared courtyard. The shared court is common open space and takes the place of a rear setback. The type is typically integrated as a small portion of lower-intensity neighborhoods or more consistently into moderate-intensity neighborhoods.

Synonym: Courtyard Apartment

2. Number of Units

Units per Design Site	As allowed by General Plan maximum density
-----------------------	--

Buildings per Design Site	1 max.
---------------------------	--------

General Note: Photos on this page are illustrative, not regulatory.

Alley access required if alley exists

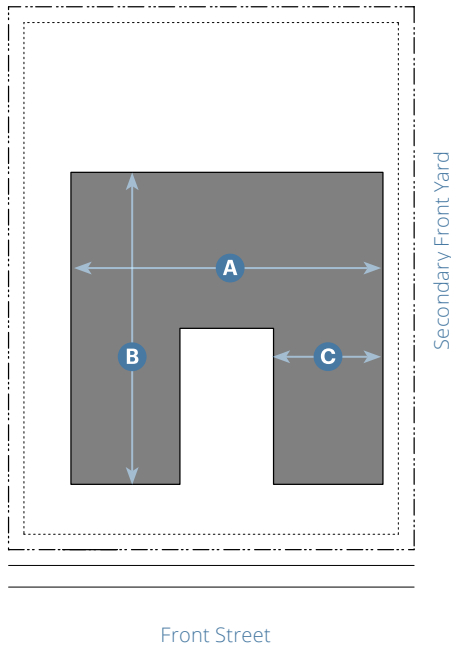

Alley access required if alley exists

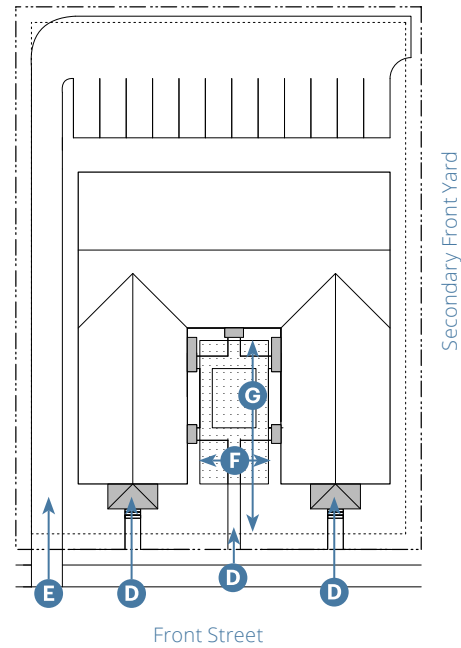

Key

- - - - ROW/ Design Site Line ■ Building
- Building Setback Line

3. Building Size and Massing

Height

Stories 2.5 max.

Main Body¹

Width Overall 100' max. **(A)**

Depth Overall 100' max. **(B)**

 45' max. **(C)**

Massing Types

Sloped Roof L (L shaped) Subsection 5.160.1.F
Courtyard

Sloped Roof Front (U-shaped) Subsection 5.160.1.G
Courtyard

Building may be designed in an L-shape or U-shape.

¹ In compliance with Subsection 5 of the district.

Key

- - - - ROW/ Design Site Line ■ Frontage
- Building Setback Line ▨ Common Open Space

4. Pedestrian Access

Main Entrance Location² Courtyard or Street **(D)**

²The main entry of ground floor units shall be directly off of a courtyard or street, whichever is closer.

5. Vehicle Access and Parking

Driveway and parking location shall comply with standards in Subsection 7 of the district. **(E)**

Parking may be covered, uncovered, or in a garage.

6. Open Space

Common Open Space	L-shaped	U-shaped	
Width	20' min.	25' min.	(F)
Depth	30' min.	60' min.	(G)

Courtyard(s) shall be accessible from the front street.

Multiple courtyards are required to be connected via a Passage through or between buildings.

Building shall define at least three walls of the courtyard.

Up to 1/3 of the shared court(s) may be used for stormwater management if designed as a rain garden or bioswale.

Front of courtyard not defined by building shall be defined by 2'-6" to 5' tall wall with entry gate/door.

This page intentionally left blank



Source: Starr Hill Vision Plan

Example of Pocket Neighborhood



Source: Ross Chapin

Example of Pocket Neighborhood



Source: Ross Chapin

Example of Pocket Neighborhood

1. Description

A group of 5 to 10 detached, House-Scale Buildings each containing one to four units, arranged to define a shared open space. The shared open space is common open space and takes the place of a private rear setback, trees become an important community-enhancing element. The type is scaled to fit within low-to-moderate intensity neighborhoods.

2. Number of Units¹

	T3NE	T4N.S
Units per Building	3 max.	4 max.
Buildings per Design Site	5 min.;	5 min.;
	6 max.	10 max.

¹ In compliance with General Plan maximum density.

General Note: Photos on this page are illustrative, not regulatory.

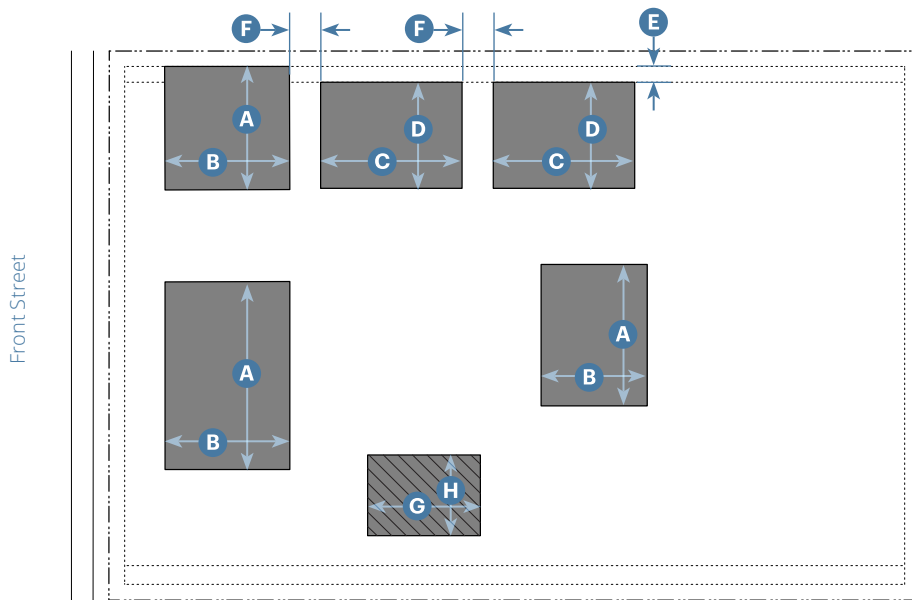

Key

- - - - ROW/ Design Site Line
- Building Setback Line
- Building
- ▨ Community Building

3. Building Size and Massing

Main Body (per Building)²

Stories	2.5 max.	
Buildings along Front Street and Secondary Front Yard		
Width	60' max.	A
Depth	40' max.	B
Buildings along Side and Rear		
Width	36' max.	C
Depth	48' max.	D
Side Setback in Addition to District Setback	5' min.	E
Building Separation ³		
Between 1-story Buildings	10' min.	F
Between Buildings > 1-story	15' min.	

Community Building^{2,4}

Stories	2.5 max.
Width	40' max. G

3. Building Size and Massing (Continued)

Depth 30' max. **H**

Massing Composition Types (per Building)

Sloped Roof	1-4 Units per Building	Subsection 5.160.1.A
Box	Building	
Sloped Roof	1-4 Units per Building	Subsection 5.160.1.B
Bar	Building	
Sloped Roof L	1-4 Units per Building	Subsection 5.160.1.C
Sloped Roof	2-4 Units per Building	Subsection 5.160.1.E
Forecourt	Building	

No single-unit buildings allowed along the front street or secondary front yard.

² In compliance with Subsection 5 of the district.

³ Including community building.

⁴ Shall front on common open space and is not allowed along front street or secondary front yard.

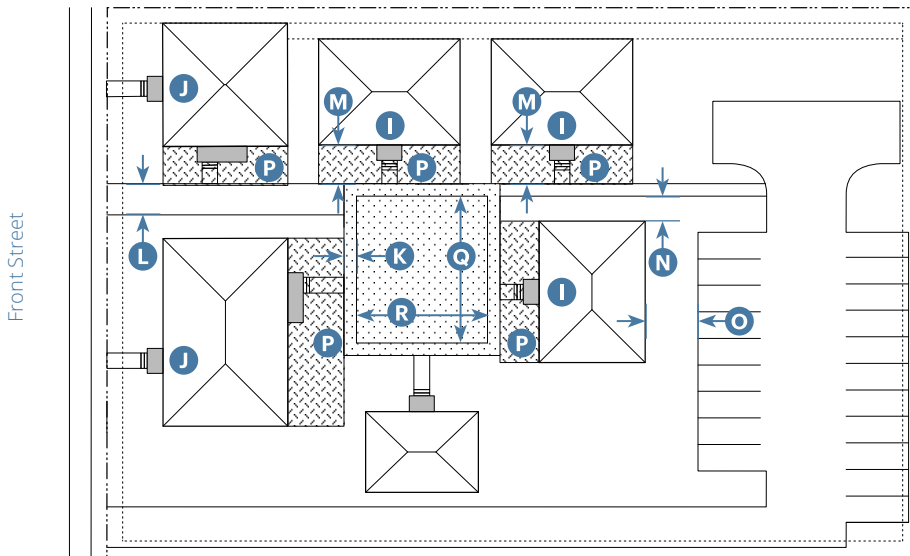

Key

- - - - ROW/ Design Site Line
- Building Setback Line
- Frontage

4. Pedestrian Access

Main Entrance Location		
Buildings with 1 Unit ⁵	At Common Open Space	I
Buildings with 2 or more Units	At Front Street or Secondary Front Yard	J
Pedestrian Path Width		
Along Buildings and Open Space	5' min.	K
At Front Street or Secondary Front Yard Connection	10' min.	L
Pedestrian Path Setbacks		
From Building Entrance	12' min.	M
From Side of Building	8' min.	N

⁵Max. 40' from edge of common open space.

5. Vehicle Access and Parking

Offset from Buildings	5' min.	O
-----------------------	---------	----------

Driveway and parking location shall comply with standards in Subsection 7 of the district.

Parking not allowed along private or common open space.

Parking may be covered, uncovered, or in a garage.

Key

- Private Open Space
- ▨ Common Open Space

Turnaround access required in compliance with Fire Department standards.

6. Open Space

Private Open Space per Building

Required for full length of building at all facades adjacent or abutting a pedestrian path or common open space. **P**

Common Open Space⁶	5 Bldgs.⁷	6-10 Bldgs.⁷
Width	30' min.	50' min. Q
Depth	40' min.	100' min. R

7. Miscellaneous

Fencing

Fencing only allowed around or between individual buildings and shall not exceed 36" in height.

Visibility shall be maintained through the fencing.

⁶Shall provide access from front street or secondary front yard.

⁷Not including community building.

5.120 Multiplex Medium



Example of Multiplex Medium



Example of Multiplex Medium



Example of Multiplex Medium

1. Description

A medium-to-large-sized, detached, House-Scale Building that consists of multiple side-by-side and/or stacked units, typically with one shared entry. The type is scaled to fit within moderate-intensity neighborhoods.

Synonym: Mansion Apartment

2. Number of Units

Units per Design Site	As allowed by General Plan maximum density
Buildings per Design Site	1 max.

General Note: Photos on this page are illustrative, not regulatory.

Alley access required if alley exists

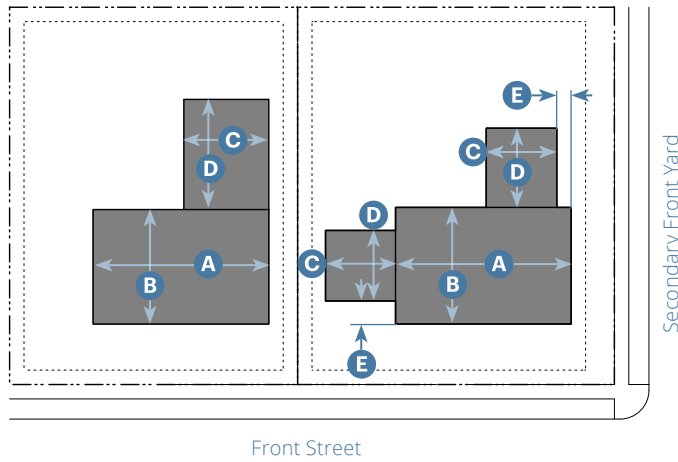

Alley access required if alley exists

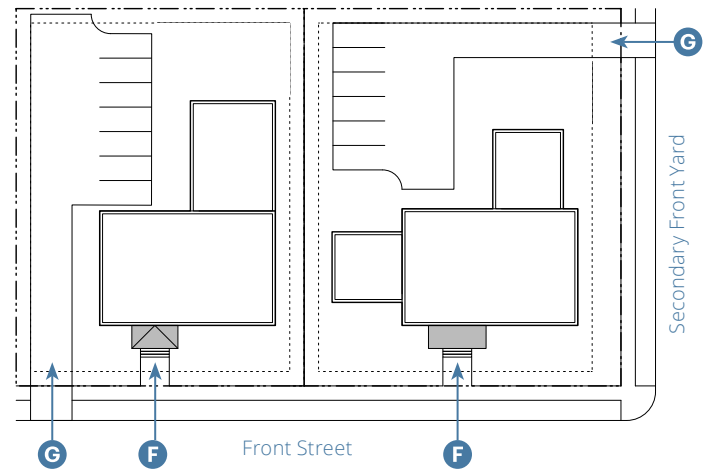

Key

- - - ROW/ Design Site Line
- Building Setback Line
- Building

3. Building Size and Massing

Height	T4N.S	T4MS.M	T4MS.S
Stories	2.5 max.	3 max.	
Main Body¹			
Width	60' max.		A
Depth	60' max.		B
Wing(s)¹			
Width	24' max.		C
Depth	40' max.		D
Separation between Wings on Same Facade	15' min.		
Offset from Main Body	5' min.		E

Massing Types

Sloped Roof Bar	Subsection 5.160.1.B
Sloped Roof L	Subsection 5.160.1.C
Sloped Roof T	Subsection 5.160.1.D
Sloped Roof Forecourt	Subsection 5.160.1.E

¹ In compliance with Subsection 5 of the district.

Key

- - - ROW/ Design Site Line
- Building Setback Line
- Frontage

4. Pedestrian Access

Main Entrance Location Front Street **F**

Units located in the main body shall be accessed by a common entry along the front street.

On corner design sites, units in a wing may enter from the secondary front yard.

5. Vehicle Access and Parking

Driveway and parking location shall comply with standards in Subsection 7 of the district. **G**

Parking may be covered, uncovered, or in a garage.

6. Open Space

Common or private open space is not required.

5.130

Core Townhouse



Example of Core Townhouse



Example of Core Townhouse



Example of Core Townhouse

1. Description

A large-sized, typically attached, Block-Scale Building with a rear setback. Each Core Townhouse consists of up to two stacked units. As allowed by the district, the type may also be detached with minimal separations between buildings. The type is typically located within high-intensity neighborhoods or on, or near, a neighborhood main street.

Synonym: Rowhouse

2. Number of Units

Units per Townhouse	2 stacked units max.
Townhouses per Design Site	1 max.
Townhouses per Run	In compliance with Subsection 5.130.3 (Building Size and Massing)

General Note: Photos on this page are illustrative, not regulatory.

Alley access required if alley exists

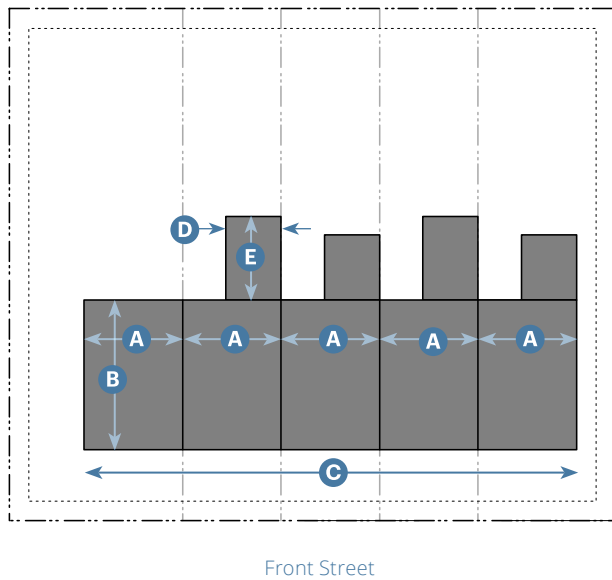

Alley access required if alley exists

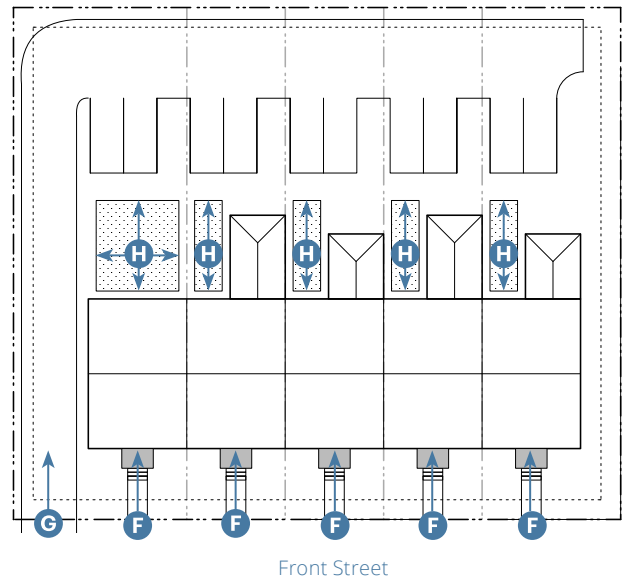

Key

- - - ROW/ Design Site Line
- Building Setback Line
- Building

3. Building Size and Massing

Height

Stories 3 max.¹

Main Body²

Width per Unit³ 18' min. **A**

Depth per Unit³ 48' max. **B**

Width per Building 200' max **C**

Wing(s)²

Width 14' max. **D**

Depth 25' max. **E**

Separation between Wings on Same Facade 15' min.

Massing Types (per Building)⁴

Sloped Roof Bar Subsection 5.160.1.B

Flat Roof Box Subsection 5.160.1.J

¹ Reflects 2 stacked units.

² In compliance with Subsection 5 of the district.

³ Includes stacked units.

⁴ Fronts of buildings within a run may be offset by 3 feet max.

Key

- - - ROW/ Design Site Line
- Building Setback Line
- Frontage
- ▨ Private Open Space

4. Pedestrian Access

Main Entrance Location Front Street **F**

Each unit shall have an individual entry facing a street or be perpendicular to a street within an alcove facing a street.

5. Vehicle Access and Parking

Driveway and parking location shall comply with standards in Subsection 7 of the district. **G**

Parking may be covered, uncovered, or in a garage.

6. Open Space

Private Open Space

Width 8' min. **H**

Depth 8' min. **H**

Required setbacks and driveways do not count toward open space.

Required private open space shall be located behind the main body of the building.

5.140 Core Courtyard



Example of Core Courtyard



Example of Core Courtyard



Example of Core Courtyard

1. Description

A detached or attached, Block-Scale Building that consists of multiple attached and/or stacked units, accessed from one or more shared courtyards. The shared court is common open space. The type is typically integrated into moderate-to-high-intensity neighborhoods and on main streets with a non-residential ground floor along the adjacent street.

Synonym: Courtyard Apartment

2. Number of Units

Units per Design Site	As allowed by General Plan maximum density
Buildings per Design Site	2 max.

General Note: Photos on this page are illustrative, not regulatory.

5.150 Main Street Building



Example of Main Street Building



Example of Main Street Building



Example of Main Street Building

1. Description

A small-to-large-sized, Block-Scale Building, typically attached, but may be detached. The type is intended to provide a vertical mix of uses with ground-floor retail, office, or service uses and upper-floor service or residential uses. The type makes up the primary component of neighborhood and downtown main streets, therefore being a key component to providing walkability.

2. Number of Units

Units per Design Site	As allowed by General Plan maximum density
Buildings per Design Site	1 max.

General Note: Photos on this page are illustrative, not regulatory.

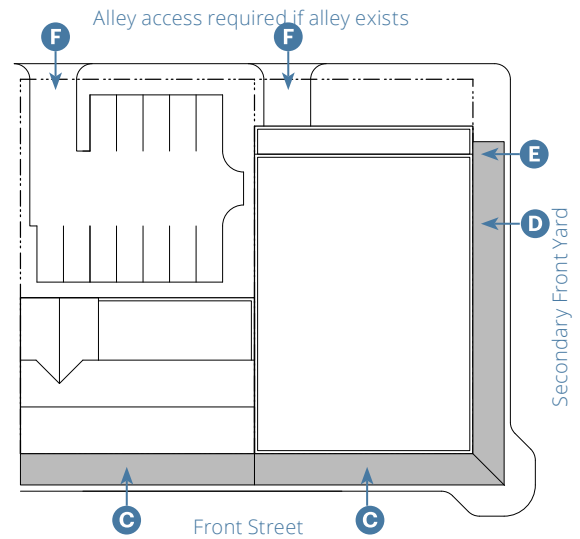
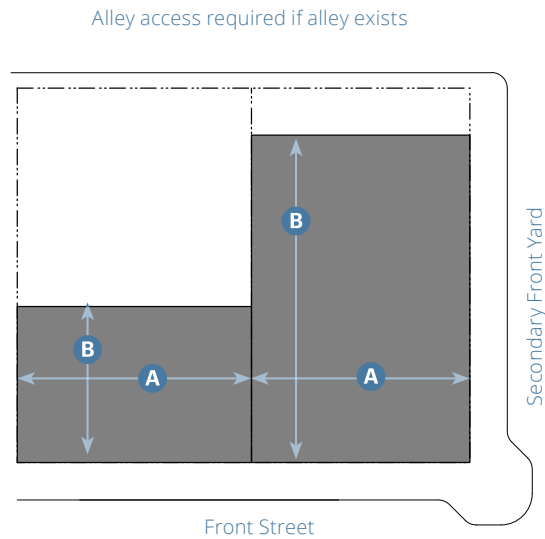

Key

- - - - ROW/ Design Site Line
- Building Setback Line
- Building

3. Building Size and Massing

Height	T4MS.S	T4MS.M
Stories	2.5 max.	3 max.
Main Body¹		
Width	100 max.	150 max. A
Depth	90 max.	120 max. B
Massing Types		
Sloped Roof Bar	Subsection 5.160.1.B	
Sloped Roof T	Subsection 5.160.1.D	
Flat Roof Box	Subsection 5.160.1.J	
Flat Roof L	Subsection 5.160.1.K	
Flat Roof T	Subsection 5.160.1.L	
Flat Roof Front Courtyard	Subsection 5.160.1.M	
Flat Roof Rear Courtyard	Subsection 5.160.1.N	
Flat Roof Closed Courtyard	Subsection 5.160.1.O	

¹ In compliance with Subsection 5 of the district.

Key

- - - - ROW/ Design Site Line
- Building Setback Line
- Frontage
- Outline of Building above

4. Pedestrian Access

- Distance between Entries to Ground Floor Shops 50' max.
- Upper floor units shall be accessed by a common entry along the front street. **C**
- Ground floor shops shall have individual entries along the adjacent street. **D**
- Ground floor units allowed along secondary front yard at least 60' from front of design site.
- On corner design sites, units in a wing or accessory structure may enter from the secondary front yard. **E**

5. Vehicle Access and Parking

- Driveway and parking location shall comply with standards in Subsection 7 of the district. **F**
- Parking may be covered, uncovered, or in a garage.

6. Open Space

Common or private open space is not required.

Missed Edit:

In Subsection 5.160.1, added text to end of first sentence ", as specified in Subsection 7.050.5 (Bay Composition)."

5.160 Massing Compositions

1. **Bay Composition.** Each façade shall be arranged according to a pattern of bays, as specified in Subsection 7.050.5 (Bay Composition). See Subsection 11.030.4 (Measuring Bays) for details on the application of bays to façades.

1. Main Body Massing Types

For each building type, select from the allowed massing types and apply the standards to the main body width facades along a street or open space in compliance with **the following standards. Façades of intersecting volumes shall be offset by a minimum of 3 feet.**

A. Sloped Roof Box

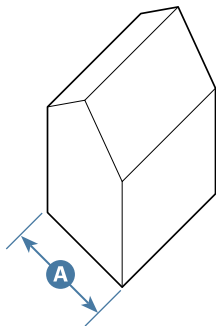

This massing type is a simple rectilinear form that is deeper than it is long. The roof is sloped and may be either hipped or gabled.

Main Body

Main Body Width	Max. allowed by Subsection 3 A of the building type
Roof Form	Gable, Hip, Shed

B. Sloped Roof Bar

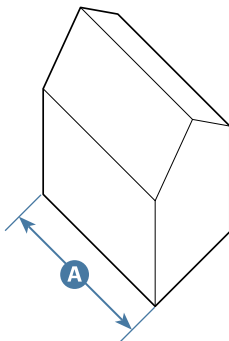

This massing type is a simple rectilinear form that is longer than it is deep. The roof is sloped and may be either hipped or gabled.

Main Body

Main Body Width	Max. allowed by Subsection 3 A of the building type
Roof Form	Gable, Hip, Shed

1. Main Body Massing Types (Continued)

C. Sloped Roof L

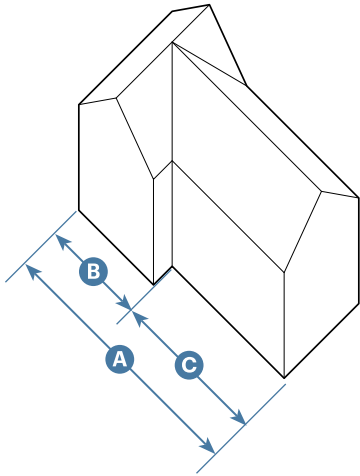

This massing type divides the façade into two parts, with one part projecting and one part set back to create a shallow forecourt. The roof is sloped, with a gable or hipped roof on each volume.

Main Body	
Main Body Width	Max. allowed by Subsection 3 A of this building type
Projecting Volume	1 bay min.; 5 bays max. B
Recessed Façade	1 bay min.; 7 bays max. C
Roof Form	Gable, Hip, Shed

D. Sloped Roof T

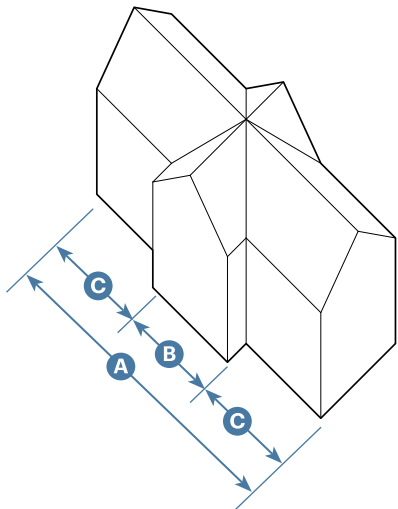

This massing type divides the façade into three parts, with the middle part projecting. The roof is sloped and may be either hipped or gabled.

Main Body	
Main Body Width	Max. allowed by Subsection 3 A of this building type
Projecting Volume	1 bay min.; 5 bays max. B
Recessed Façade	1 bay min.; 7 bays max. C
Roof Form	Gable, Hip, Shed

Missed Edit:
Added diagram label "C"

E. Sloped Roof Forecourt

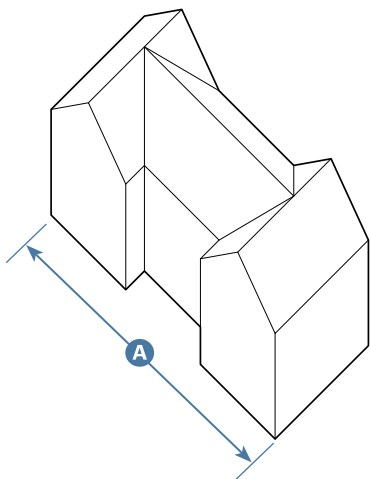

This massing type divides the façade into three parts, with the middle part set back slightly to create a shallow open space. The roof is sloped and may be either hipped or gabled.

Main Body	
Main Body Width	Max. allowed by Subsection 3 A of this building type
Projecting Volume	1 bay min.; 5 bays max.
Recessed Façade	1 bay min.; 9 bays max.
Roof Form	Gable, Hip, Shed

1. Main Body Massing Types (Continued)

F. Sloped Roof L Courtyard

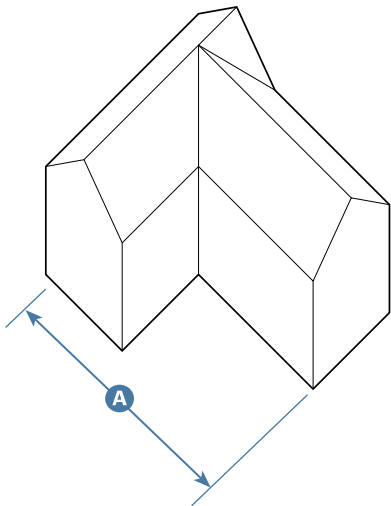

This massing type divides the façade into two parts, with one part set back substantially to create a deep open space. The roof is sloped and may be either hipped or gabled.

Main Body

Main Body Width	Max. allowed by Subsection 3 A of this building type
Projecting Volume	1 bay min.; 5 bays max.
Recessed Façade	1 bay min.; 9 bays max.
Roof Form	Gable, Hip, Shed

G. Sloped Roof Front Courtyard

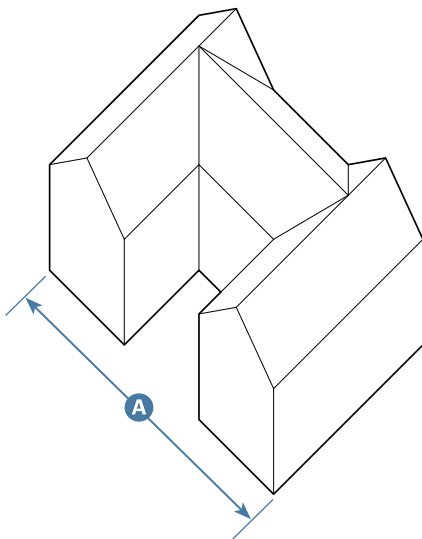

This massing type divides the façade into three parts, with the middle part set back substantially to create a deep open space. The roof is sloped and may be either hipped or gabled.

Main Body

Main Body Width	Max. allowed by Subsection 3 A of this building type
Projecting Wing	1 bay min.; 5 bays max.
Center Façade	1 bay min.; 7 bays max.
Roof Form	Gable, Hip, Shed

1. Main Body Massing Types (Continued)

H. Sloped Roof Rear Courtyard

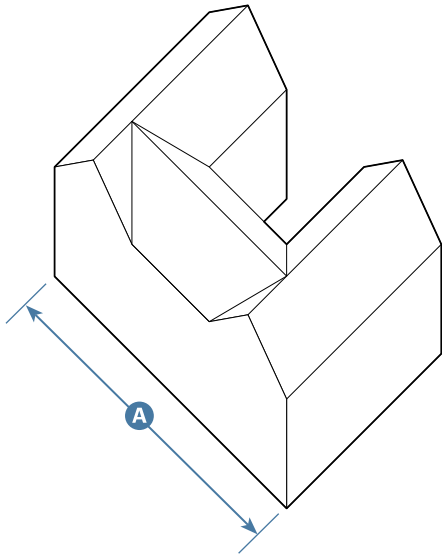

This massing type divides the rear façade into three parts, with the middle part set back substantially to create a deep courtyard not visible from the street. The roof is sloped and may be either hipped or gabled.

Main Body

Main Body Width	Max. allowed by Subsection 3 A of this building type
Roof Form	Gable, Hip, Shed

I. Sloped Roof Closed Courtyard

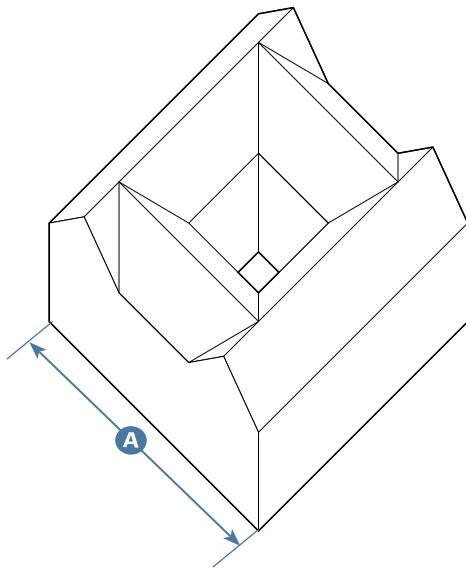

This massing type fronts a courtyard with building façades in all 4 sides. Courtyard not visible from the street. The roof is sloped and may be either hipped or gabled.

Main Body

Main Body Width	Max. allowed by Subsection 3 A of this building type
Roof Form	Gable, Hip, Shed

1. Main Body Massing Types (Continued)

J. Flat Roof Box

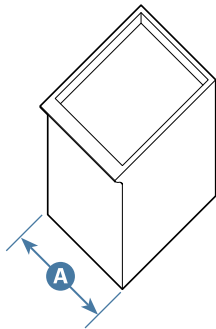

This massing type is a simple rectilinear form with a flat roof.

Main Body

Main Body Width	Max. allowed by Subsection 3 A of this building type
Roof Form	Flat

K. Flat Roof L

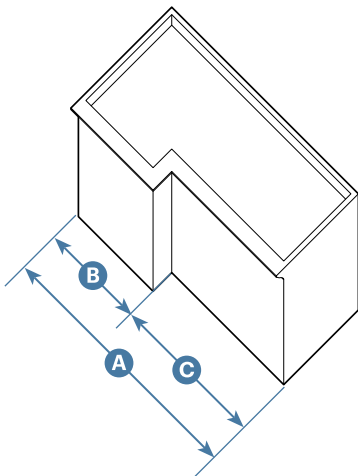

This massing type divides the façade into two parts, with one part projecting and one part set back to create a shallow forecourt. The roof is flat.

Main Body

Main Body Width	Max. allowed by Subsection 3 A of this building type
Projecting Volume	2 bays min.; 5 bays max. B
Recessed Façade	1 bay min.; 7 bays max. C
Roof Form	Flat

L. Flat Roof T

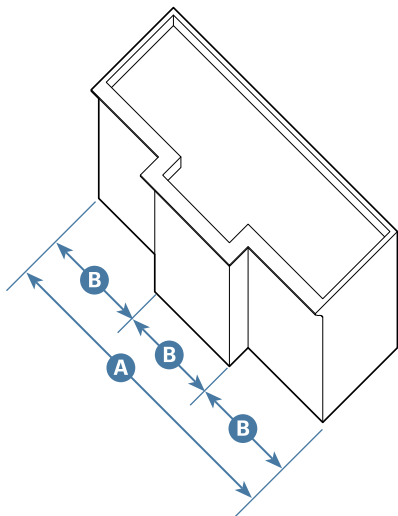

This massing type divides the façade into three parts, with the middle part projecting. The roof is flat.

Main Body

Main Body Width	Max. allowed by Subsection 3 A of this building type
Projecting Volume	2 bays min.; 5 bays max. B
Recessed Façade	1 bay min.; 7 bays max. C
Roof Form	Flat

1. Main Body Massing Types (Continued)

M. Flat Roof Front Courtyard

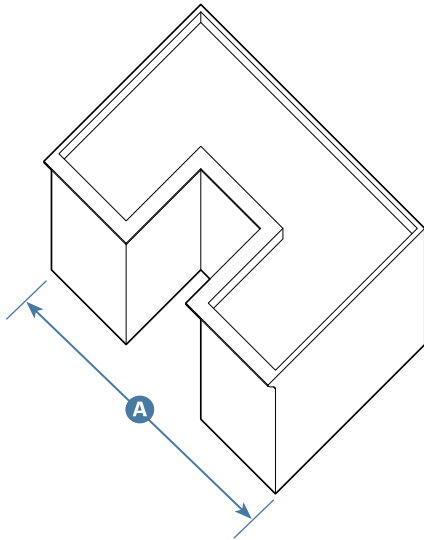

This massing type divides the façade into three parts, with the middle part set back substantially to create a deep open space. The roof is flat.

Main Body

Main Body Width	Max. allowed by Subsection 3 A of this building type
Projecting Volume	1 bay min.; 5 bays max.
Recessed Façade	1 bay min.; 9 bays max.
Roof Form	Flat

N. Flat Roof Rear Courtyard

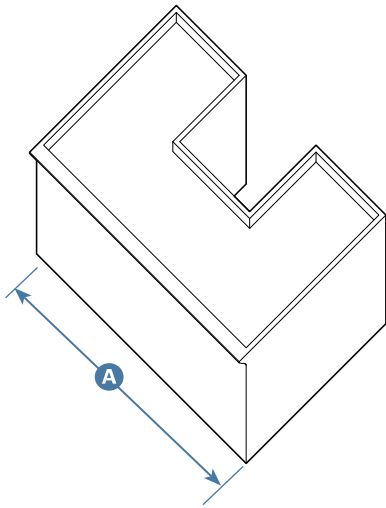

This massing type divides the rear façade into three parts, with the middle part set back substantially to create a deep courtyard not visible from the street. The roof is flat.

Main Body

Main Body Width	Max. allowed by Subsection 3 A of this building type
Roof Form	Flat

1. Main Body Massing Types (Continued)

O. Flat Roof Closed Courtyard

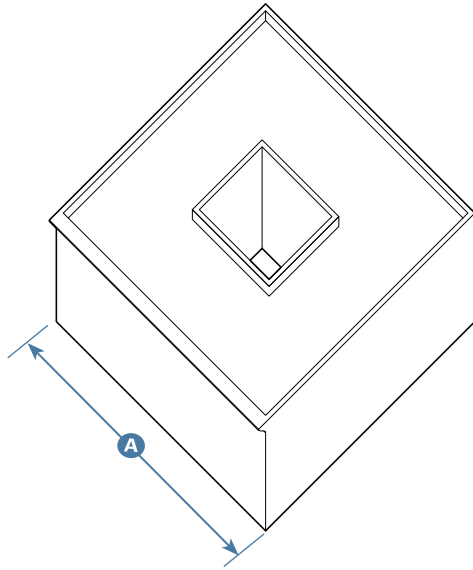

This massing type fronts a courtyard with building façades in all 4 sides. Courtyard not visible from the street. The roof is flat.

Main Body

Main Body Width	Max. allowed by Subsection 3 A of this building type
Roof Form	Flat

Chapter 6: Specific to Private Frontage Types

Sections:

6.010	Purpose
6.020	General Requirements for Private Frontage Types
6.030	Allowed Private Frontage Types
6.040	Porch Projecting
6.050	Porch Engaged
6.060	Dooryard
6.070	Stoop
6.080	Forecourt
6.090	Maker Shopfront
6.100	Shopfront
6.110	Terrace
6.120	Gallery

6.010 Purpose

This Chapter provides the standards for private frontages ("frontages"). Private frontages are the components of a building that provide the transition and interface between the public realm (street and sidewalk) and the private realm (setback or building).

6.020 General Requirements for Private Frontage Types

1. The names of the private frontage types indicate their particular configuration or function and are not intended to limit uses within the associated building. For example, a Porch may be used by non-residential uses including, but not limited to, a restaurant or office, as allowed by the district.
2. Each building is required to include at least one private frontage type along the front street or adjacent open space. Buildings with entries along a secondary front yard are required to include at least one private frontage type on those facades.
3. The ground floor, for a minimum depth as identified in Subsection 4 of the district, is required to be habitable/occupiable space in compliance with this Chapter. Accessibility is provided through the allowed private frontage types for each district.
4. Private frontage types not listed in Subsection 8 of the district are not allowed in that district.
5. Each building may have multiple private frontage types in compliance with the allowed types in Subsection 8 of the district.
6. Each private frontage type shall be located in compliance with the facade zone per Subsection 5 of the district.
7. Access and egress areas which are designed to provide access/egress and remain open and passable such as front porches, landings, stairs, and ramps, or required access/egress paths on a multi-unit or mixed-use development.
8. Standards are stated for the front and secondary front yard facades of a design site.

9. In addition to the district's standards, each private frontage is further refined through these standards to further calibrate the type for its context.
10. Certain types are only allowed in the open sub-district (e.g., T4N.S-O) or on a secondary front yard in the base district (e.g., T4MS.M) to implement the intended physical character.
11. Ramps connecting a private frontage type and ROW shall be designed in compliance with the following:
 - A. Located along the side of the building; and/or
 - B. Parallel to the front facade and not exceed 18 inches in rise; ramp shall include a wall up to 36 inches tall that includes a landscape planter at least 2 feet wide or a bench. The wall shall be designed using any of the wall materials on the main building.

6.030 Allowed Private Frontage Types

Table A (Allowed Private Frontage Types) provides a summary of the allowed private frontage types in each district. See referenced Section(s) for standards. The frontages allowed by district are coordinated with the building types allowed in each district.

Table 6.030.A: Allowed Private Frontage Types

Private Frontage Type	Specific Standards	Districts			
		T3	T4		
		NE	N.S	MS.S	MS.M
Porch Projecting	6.040	P	P	P	---
Porch Engaged	6.050	P	P	P	---
Dooryard	6.060	P	P	P	O
Stoop	6.070	---	P	P	---
Forecourt	6.080	---	P	P	P
Maker Shopfront	6.090	---	P	O	O
Shopfront	6.100	---	O	P	P
Terrace	6.110	---	O	P	P
Gallery	6.120	---	O	P	P

Key P = Allowed O = Allowed Only in Open Sub-District or Secondary Front Yard --- = Not Allowed

This page intentionally left blank

6.040 Porch Projecting



Example of a Projecting Porch



Example of a Projecting Porch

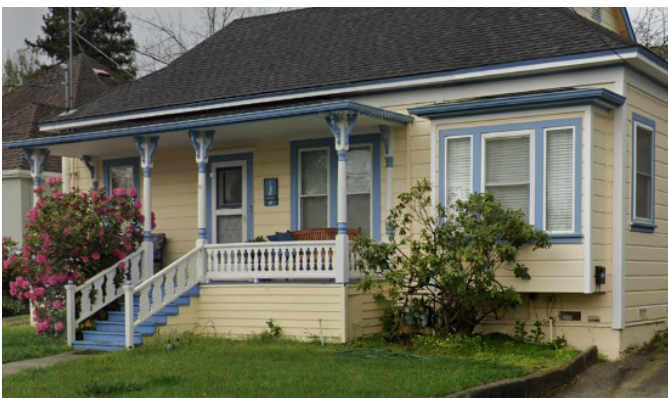

Example of a Projecting Porch

1. Description

The main facade of the building is set back from the front design site line with a covered structure encroaching into the front setback. The resulting setback area may be defined by a fence or hedge to spatially maintain the edge of the street. The Porch may be one or two stories, is open on three sides, with all habitable space located behind the building setback line.

General Note: Photos on this page are illustrative, not regulatory.

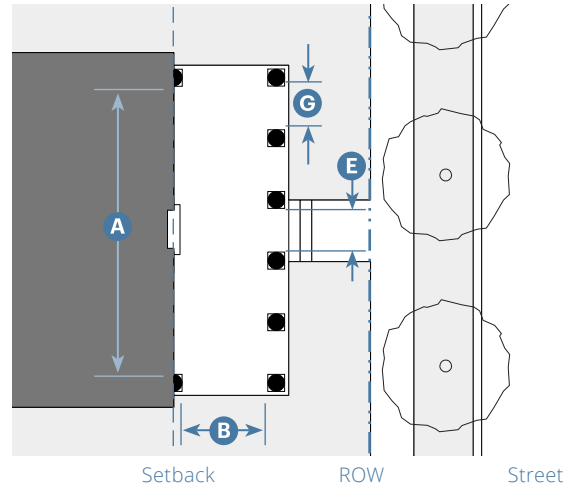
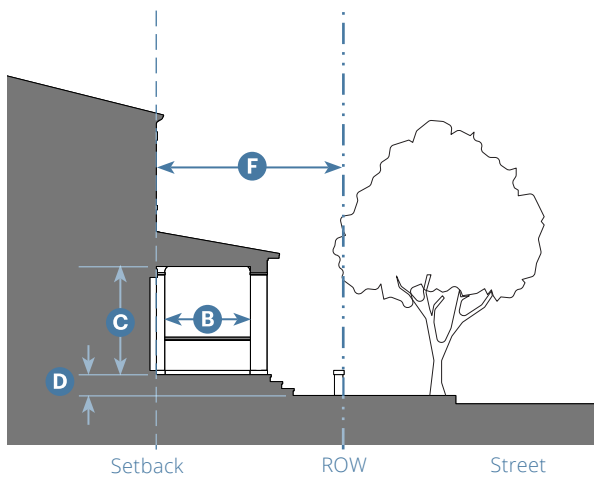

Key

--- ROW/ Design Site Line - - - - - Setback Line

2. Size		
Width, Clear	15' min. ¹	A
Depth, Clear	8' min.	B
Height, Clear	8' min.	C
Stories	2 stories max.	
Finish Level above Sidewalk	12" min. ²	D
Pedestrian Access	3' wide min.	E
Depth	15' min.	F
Distance between Porch columns shall be in compliance with selected architectural style in Chapter 7 (Specific to Architectural Design).		G

¹Reduce to 8' min. and maximum 1 story when applied to Cottage Court Building Type

²Common entries may be set at grade per local and federal accessibility standards.

3. Miscellaneous

Porch shall be open on three sides and have a roof. Clear glass may be installed between the porch columns if the minimum size of individual panes is in compliance with the standards in Chapter 7 (Specific to Architectural Design).

The Porch is allowed to encroach into the front and secondary front yard setbacks in compliance with Subsection 6 of the district.

The Porch shall be designed in compliance with the standards in Chapter 7 (Specific to Architectural Design) for the selected architectural style.

6.050 Porch Engaged



Example of an Engaged Porch



Example of a Engaged Porch



Example of an Engaged Porch

1. Description

A portion of the main facade of the building is set back from the front design site line to create an area for a covered structure that projects from the facade that is set back. The Porch may project into the front setback. The resulting setback may be defined by a fence or hedge to spatially maintain the edge of the street. The Porch may be one or two stories and has two adjacent sides that are engaged to the building, while the other two sides are open.

General Note: Photos on this page are illustrative, not regulatory.

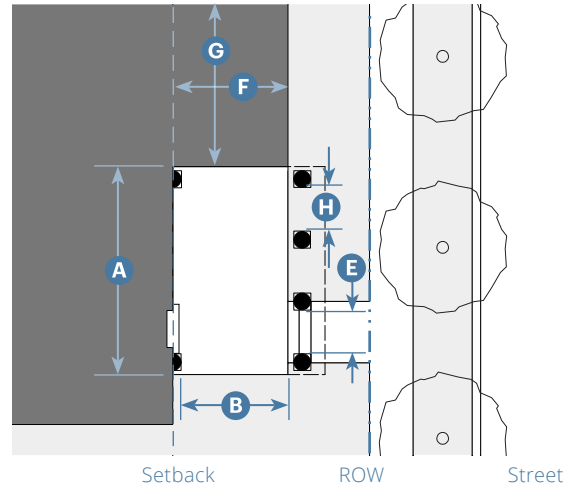
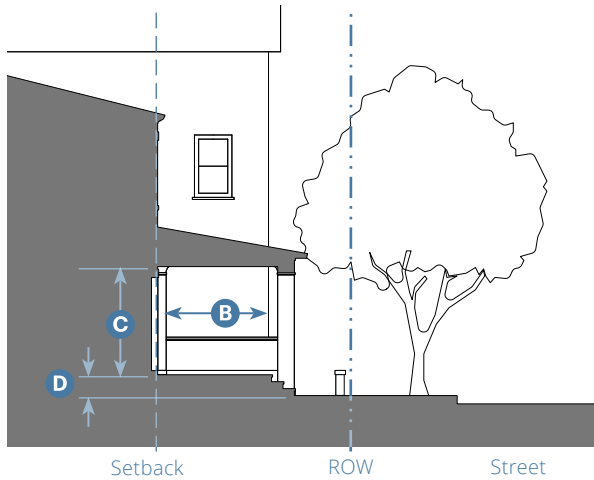

Key

--- ROW/ Design Site Line - - - - - Setback Line

2. Size		
Width, Clear	8' min.	A
Depth, Clear	8' min.	B
Height, Clear	8' min.	C
Stories	2 stories max.	
Finish Level above Sidewalk	12" min. ¹	D
Pedestrian Access	3' wide min.	E
Encroachment Area of Building Facade		
Depth	6' max	F
Width	1/3 min. of overall building facade	G
Distance between Porch columns shall be in compliance with selected architectural style in Chapter 7 (Specific to Architectural Design). H		

¹Common entries may be set at grade per local and federal accessibility standards.

G

3. Miscellaneous

Up to 20% of the building facade and porch(es) may project into the front setback line for the district.

Porch shall be open on two sides and have a roof. Clear glass may be installed between the porch columns if the minimum size of individual panes is in compliance with the standards in Chapter 7 (Specific to Architectural Design).

The Porch is allowed to encroach into the front and secondary front yard setbacks in compliance with Subsection 6 of the district.

The Porch shall be designed in compliance with the standards in Chapter 7 (Specific to Architectural Design) for the selected Architectural Style.

6.060 Dooryard



Example of a Dooryard



Example of a Dooryard

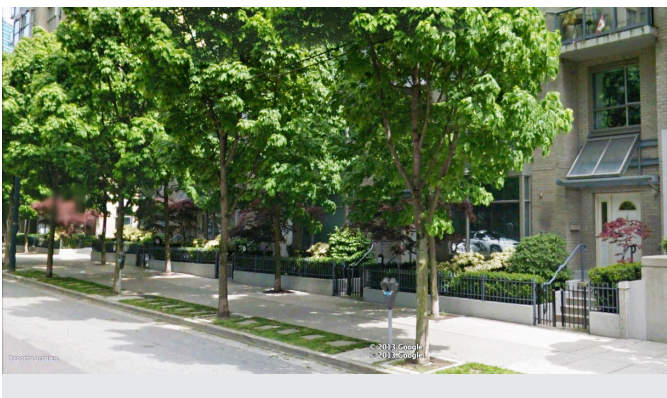

Example of a Dooryard

1. Description

The main facade of the building is set back from the front design site line, which is defined by a low wall or hedge, creating a small private area between the sidewalk and the facade. Each Dooryard is separated from adjacent Dooryards. The Dooryard may be raised or at grade.

General Note: Photos on this page are illustrative, not regulatory.

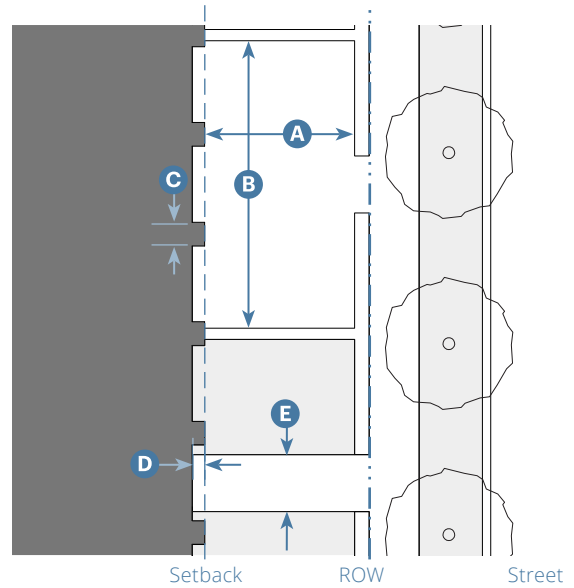
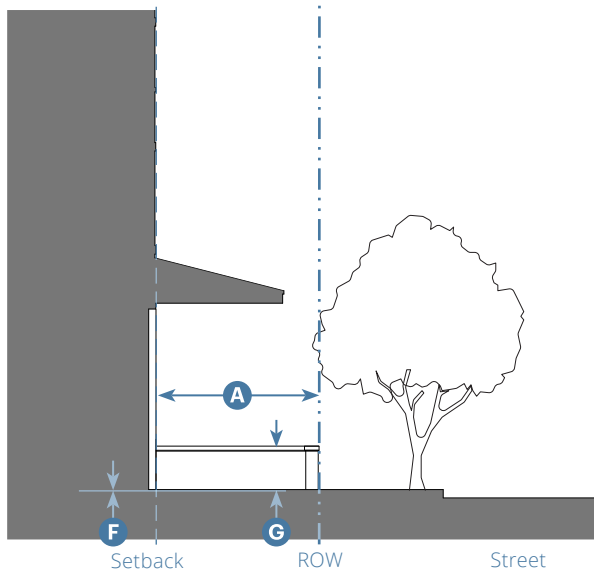

Key

- · - · - ROW/ Design Site Line - - - - - Setback Line

2. Size

Depth, Clear	6' min.	A
Length	15' min.	B
Distance between Glazing	4' max.	C
Depth of Recessed Entries	3' max.	D
Pedestrian Access	3' wide min.	E
Finish Level above Sidewalk	12" max. ¹	F
Height of Dooryard Fence/Wall above Finish Level	36" max.	G

¹Common entries may be set at grade per local and federal accessibility standards.

3. Miscellaneous

For live/work, retail, service, and restaurant uses, the Shopfront Frontage Type (6.100) may be applied.

Each Dooryard shall provide access to only one ground floor entry.

The Dooryard is allowed to encroach into the front and secondary front yard setbacks in compliance with Subsection 6 of the district.

The Dooryard shall be designed in compliance with the standards in Chapter 7 (Specific to Architectural Design) for the selected architectural style.

6.070 Stoop



Example of a Stoop



Example of a Stoop



Example of a Stoop

1. Description

The main facade of the building is near the front design site line with steps to an elevated entry. The Stoop is elevated above the sidewalk to provide privacy along the sidewalk-facing rooms. Stairs or ramps from the Stoop may lead directly to the sidewalk or may be parallel to the sidewalk.

General Note: Photos on this page are illustrative, not regulatory.

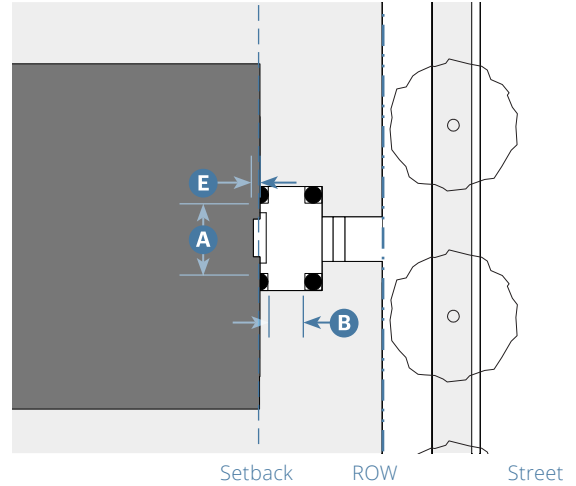
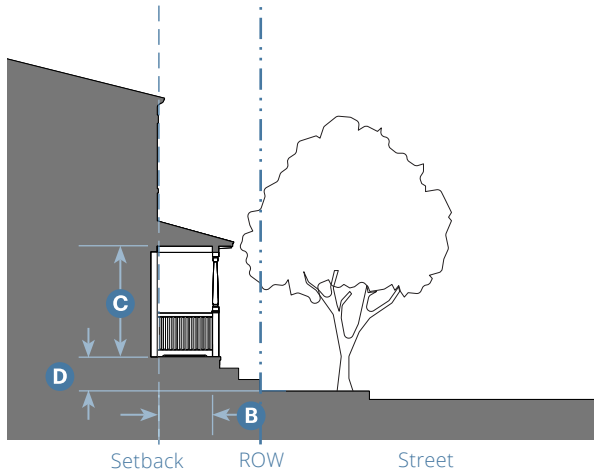

Key

--- ROW/ Design Site Line - - - - - Setback Line

2. Size		
Width, Clear	4' min.	A
Depth, Clear	3' min.	B
Height, Clear	8' min.	C
Stories	1 story max.	
Finish Level above Sidewalk	12" min.	D
Depth of Recessed Entries	8' max.	E

3. Miscellaneous

Stairs may be perpendicular or parallel to the building facade.

Entry doors shall be covered or recessed to provide shelter from the elements.

Gates are not allowed at the top of the stair.

All doors shall face the street.

The Stoop is allowed to encroach into the front and secondary front yard setbacks in compliance with Subsection 6 of the district.

The Stoop shall be designed in compliance with the standards in Chapter 7 (Specific to Architectural Design) for the selected architectural style.

6.080 Forecourt



Example of a Forecourt



Example of a Forecourt



Example of a Forecourt

1. Description

The main facade of the building is at or near the front design site line and a portion is set back, extending the public realm into the design site to create an entry court or shared garden space for housing, or an additional shopping or restaurant seating area within retail and service areas.

General Note: Photos on this page are illustrative, not regulatory.

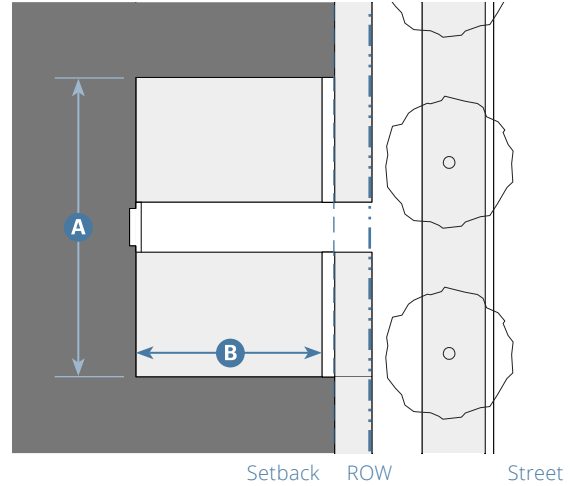
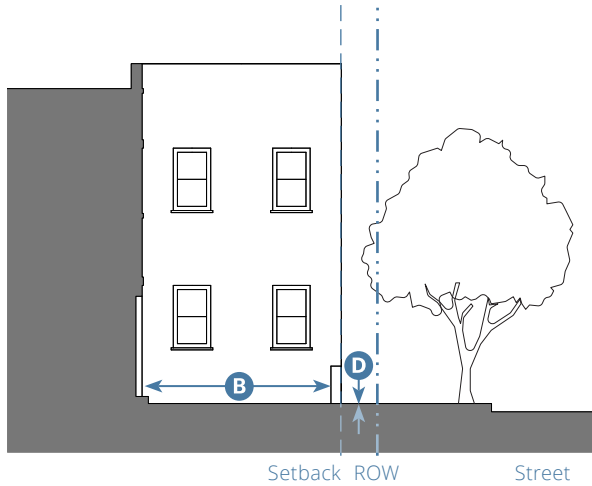

Key

--- ROW/ Design Site Line Setback Line

2. Size		
Width, Clear	15' min.	A
Depth, Clear	15' min.	B
Ratio, Height to Width	2:1 max.	C
Finish Level above Sidewalk	12" max.	D
Gallery frontages, awnings, balconies and porches may encroach into Forecourt on all sides.	Up to 1/4 width or depth max., per Forecourt side	E

3. Miscellaneous

Forecourts may be utilized to group several entries at a common elevation in compliance with the districts' ground floor finish level standards.

The proportions and orientation of a Forecourt shall be in compliance with the diagram below for solar orientation and user comfort.

The Forecourt shall be designed in compliance with the standards in Chapter 7 (Specific to Architectural Design) for the selected architectural style.

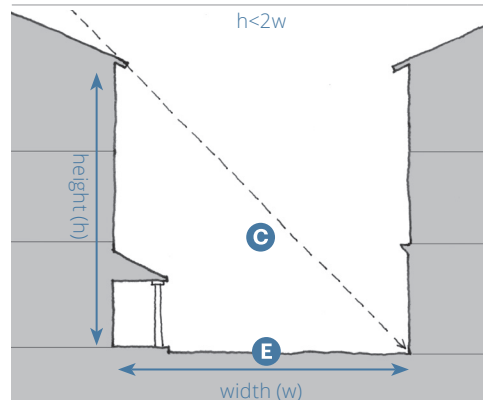

6.090 Maker Shopfront



Example of a Maker Shopfront



Example of a Maker Shopfront



Example of a Maker Shopfront

1. Description

The main facade of the building is at or near the front design site line with an at-grade or elevated entrance from the sidewalk. The type is only allowed on secondary front yards from the adjacent main street and is intended for industrial artisan businesses to show their activity to pedestrians, as well as for retail sales of products made on-site. The Maker Shopfront may include a decorative roll-down or sliding door, including glazing and an awning that overlaps the sidewalk.

General Note: Photos on this page are illustrative, not regulatory.

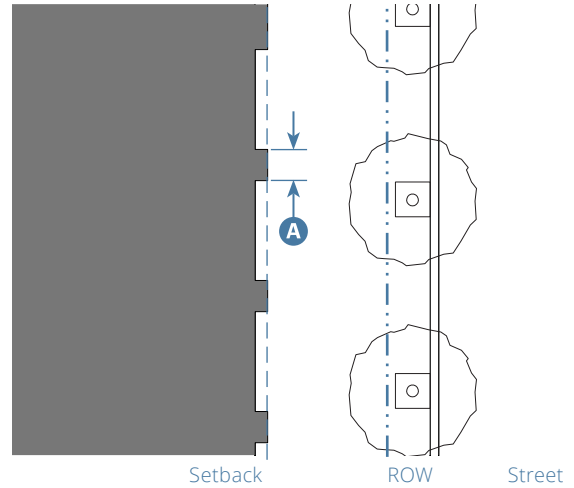
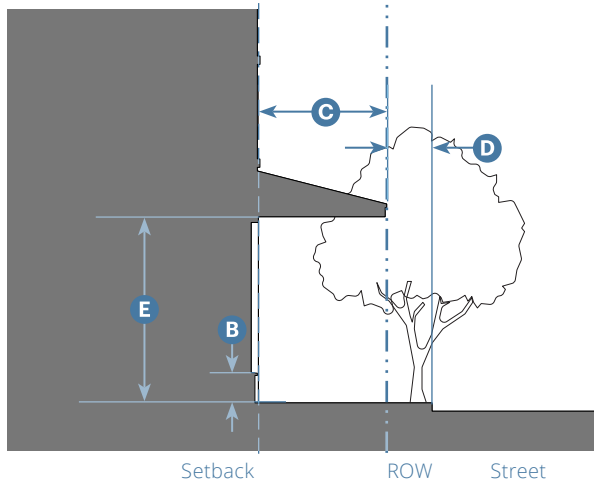

Key

--- ROW/ Design Site Line - - - - - Setback Line

2. Size

Distance between Glazing	10' max.	A
Ground Floor Glazing between Sidewalk and Finished Ceiling Height	30% min.	
Depth of Recessed Entries	No max.	
Shopfront Base (if used)	48" max.	B

3. Awning

Depth	5' min.	C
Setback from Curb	2' min.	D
Height, Clear	8' min.	E

4. Miscellaneous

Decorative accordion-style doors/windows or other operable windows that allow the space to open to the street are allowed in compliance with Chapter 7 (Specific to Architectural Design).

The Maker Shopfront shall be designed in compliance with the standards in Chapter 7 (Specific to Architectural Design) for the selected architectural style.

6.100 Shopfront



Example of Shopfronts



Example of a Shopfront



Example of a Shopfront

1. Description

The main facade of the building is at or near the front design site line with at-grade entrance from the sidewalk. The type is intended for service, retail, or restaurant use and includes substantial glazing between the Shopfront base and the ground floor ceiling. This type may include an awning that overlaps the sidewalk.

General Note: Photos on this page are illustrative, not regulatory.

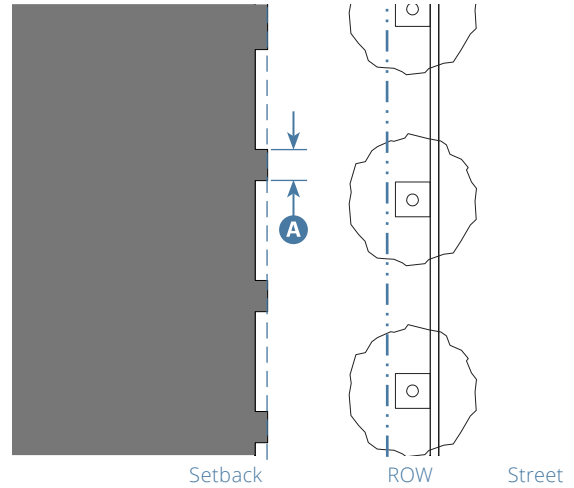
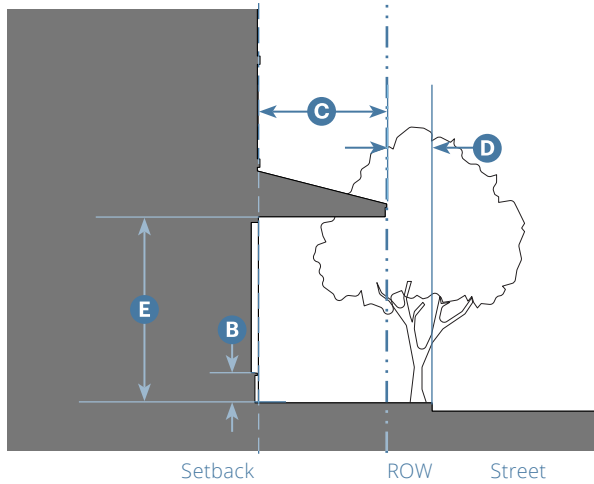

Key

--- ROW/ Design Site Line - - - - - Setback Line

2. Size

Distance between Glazing	2' max.	A
Ground Floor Glazing between Sidewalk and Finished Ceiling Height	75% min.	
Depth of Recessed Entries	5' max.	
Shopfront Base (if used)	6" min.; 24" max.	B

3. Awning

Depth	5' min.	C
Setback from Curb	2' min.	D
Height, Clear	8' min.	E

4. Miscellaneous

Decorative accordion-style doors/windows or other operable windows that allow the space to open to the street are allowed in compliance with Chapter 7 (Specific to Architectural Design).

The Shopfront shall be designed in compliance with the standards in Chapter 7 (Specific to Architectural Design) for the selected architectural style.

Missed Edit(s):
 1. Added text "(if used)"
 2. Delete min. standard for Shopfront Base Height

6.110 Terrace



Example of a Terrace

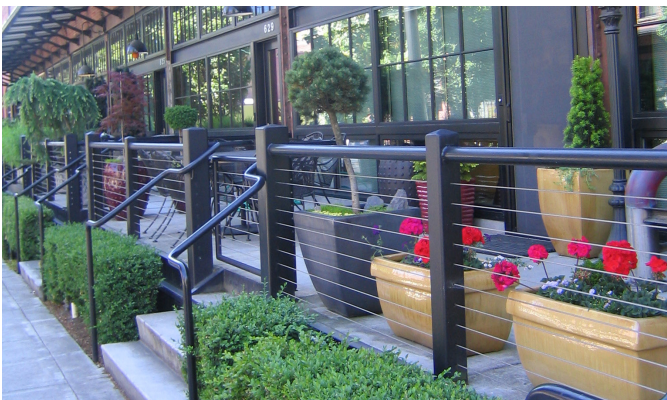

Example of a Terrace



Example of a Terrace

1. Description

The main facade is at or near the front design site line with steps leading to an elevated area providing pedestrian circulation along the facade. The type is used for retail, service, office uses, or housing to provide outdoor areas along the sidewalk and/or to accommodate an existing or intended grade change.

General Note: Photos on this page are illustrative, not regulatory.

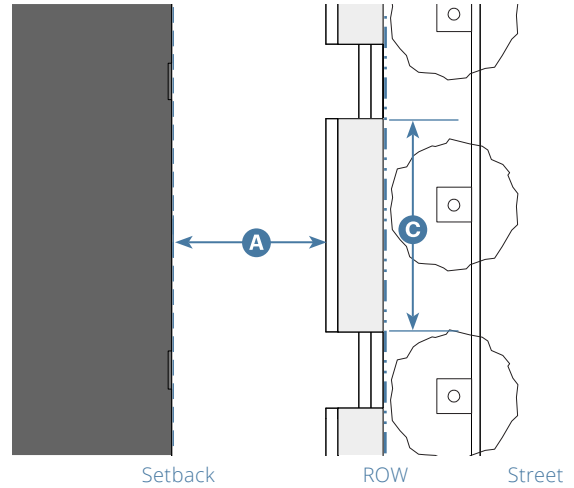
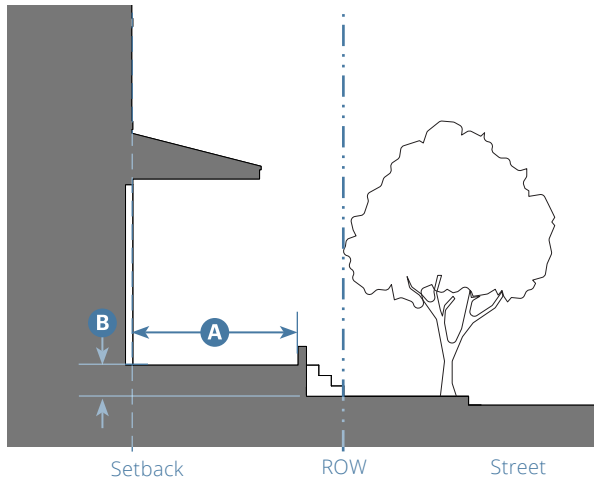

Key

--- ROW/ Design Site Line - - - - - Setback Line

2. Size		
Depth of Terrace	8' min. residential; 12' min. non-residential	A
Finish Level above Sidewalk	36" max.	B
Distance between Stairs	25' max.	C

3. Miscellaneous

These standards are to be used with those for the Shopfront Frontage Type where the district requires the Shopfront Frontage Type (6.100).

Where the district requires the Shopfront Frontage Type (6.100) and the ground floor is flush with the sidewalk, the Terrace shall be considered to be the sidewalk.

May be utilized to group several entries at a common elevation in compliance with the districts' ground floor finish level standards.

The Terrace is allowed to encroach into the front and secondary front yard setbacks in compliance with Subsection 6 of the district.

The Terrace shall be designed in compliance with the standards in Chapter 7 (Specific to Architectural Design) for the selected architectural style.

6.120 Gallery



Source: Google Street View

Example of a Gallery



Example of a Gallery



Example of a Gallery

1. Description

The main facade of the building is set back from the front design site line and an at-grade covered structure, articulated with colonnade or arches, overlaps the sidewalk. The type may be one or two stories. When used in nonresidential settings, the Shopfront Type is included; when used in residential settings, Stoops, Dooryards, and Forecourts may be included as allowed by the district.

General Note: Photos on this page are illustrative, not regulatory.

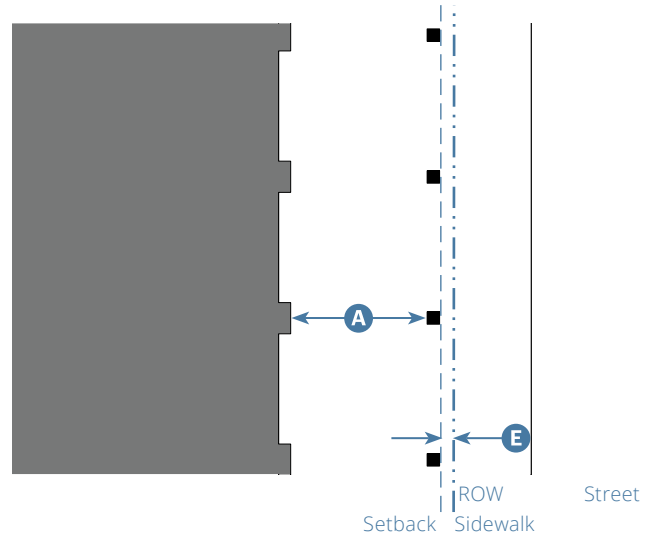
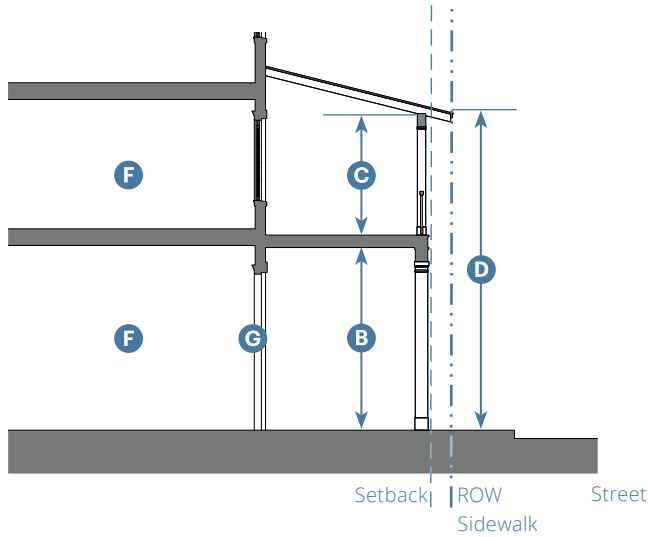

Key

- - - - ROW/ Design Site Line
- Setback Line

2. Size		
Depth, Clear	8' min.	A
Ground Floor Height, Clear	12' min.	B
Upper Floor Height, Clear	9' min.	C
Height	2 stories max.	D
Gallery Setback from Public ROW	18" min. (clear)	E

- | 3. Miscellaneous | |
|--|----------|
| Habitable space | F |
| Galleries shall also follow the standards for the Shopfront Frontage Type (6.100). | G |
| Galleries shall have a consistent depth across the entire front street and/or secondary front yard facade. | |
| The Gallery is not allowed to project over the public ROW. | |
| The second story of the Gallery may be covered. | |
| Planting is not required. Lighting is required within the gallery in compliance with Section 4.030.3. | |
| The Gallery shall be designed in compliance with the standards in Chapter 7 (Specific to Architectural Design) for the selected architectural style. | |

This page intentionally left blank

Chapter 7: Specific to Architectural Design

Sections:

7.010	Purpose
7.020	Applicability
7.030	Architectural Design Standards
7.040	Architectural Variety Standards
7.050	Building Volume and Façade Composition Standards
7.060	Bird Safety
7.070	Durability
7.080	Privacy Standards
7.090	Standards for Architectural Elements

Missed Edit(s):

1. Deleted all standards regulating color
2. Updated date in footer for all pages in Chapter 7

7.010 Purpose

This Chapter sets forth standards that supplement the district standards to further refine the intended building form and physical character.

7.020 Applicability

Unless stated otherwise, all subsections within this Chapter apply to all façades of new buildings and all façades proposed for renovation. Fire walls, visible party walls, and side interior façades less than 5 feet from a shared design site line are exempt, except where specifically regulated.

7.030 Architectural Design Standards

1. The standards address the following aspects of building design without regulating architectural style:
 - A. Architectural variety;
 - B. Composition of building volumes and facades;
 - C. Treatment of elements for durability, privacy, and bird safety;
 - D. Roofs, including roof pitch, rakes, and eaves, parapets, and cornices;
 - E. Walls and base of walls;
 - F. Windows, doors, and other openings, including dormers;
 - G. Balconies;
 - H. Porches;
 - I. Storefronts;
 - J. Usage of materials ~~and colors~~.

Quick Code Guide: Specific to Architectural Design

The following graphic is intended as a summary guide. Please refer to the procedures for applications eligible for streamlined review consistent with State Law [Section 10.020 (Procedures)]

Before you begin

Identify your district, building type, and detailed massing type. If you have not done this yet, go back to the Table of Contents and follow the Quick Code Guide.

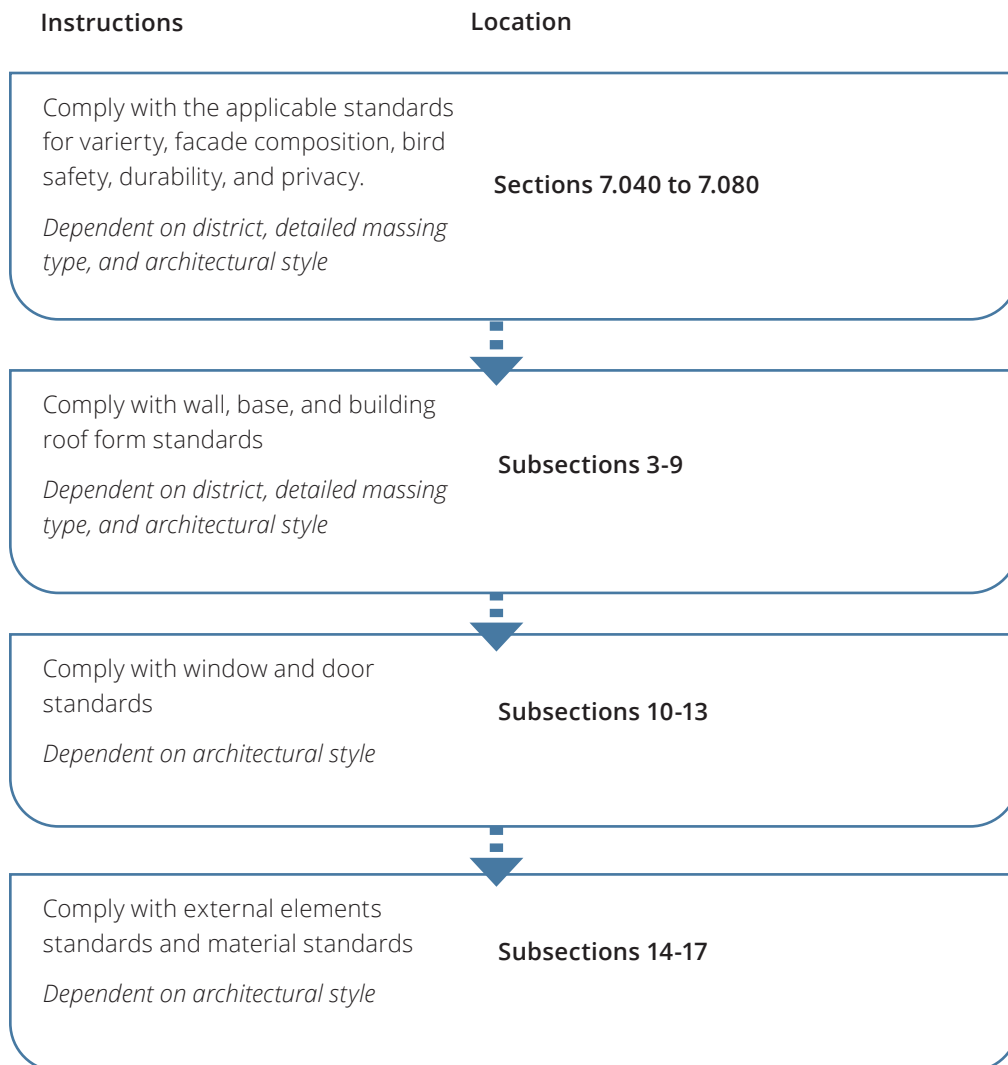

7.040 Architectural Variety Standards

1. **Applicability.** The standards in this Section apply to new buildings or façade renovations. Building types that include multiple buildings on a design site (e.g., Cottage Court) are treated as a single building for the purpose of applying the standards in this Section.
2. **Building Character.** The applicant may repeat each of the following features identically on no more than two new or renovated buildings along the same block face. ~~The primary wall color and~~ At least two of the features listed below shall differ between adjacent buildings.
 - A. Typical windows and doors, including surrounds and sills
 - B. Balcony assembly (if present), including guards/railings
 - C. Profile and/or assembly of eave, cornice, or parapet, as applicable
 - D. Shape or profile of architectural detailing as applied to frontage type
 - E. Primary wall texture

Figure 7.040.1 Example of Differentiation Among Buildings Along the Same Block Face

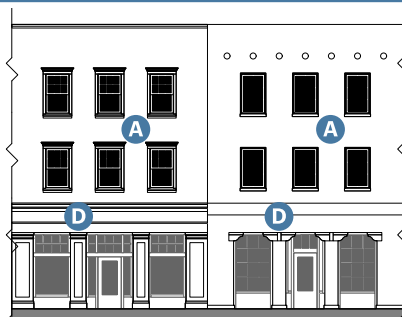

- A** Typical windows and doors (Left example: double-hung windows with classical surrounds vs. Right example: casement windows with simple brick molding)
- D** Shape or profile of architectural detailing as applied to frontage (Left example: classical panels/moldings/entablature vs. Right example: piers/brackets/expression line)

7.050 Building Volume and Façade Composition Standards

1. **Applicability.** The standards in this Section apply to new buildings or façade renovations.
2. **Building Types and Massing.** New buildings shall comply with the standards in this Subsection:
 - A. **Massing Types.** A massing type shall be selected from the allowed massing type(s) for the selected building type, as listed in Section 3 of the building type standards. The standards for each massing type are provided in Section 5.170 (Massing Types).
 - B. **Primary Roof Form and Massing.** The primary roof form shall be designed according to the applicable massing type(s) for the selected building type, subject to the following standards and exceptions:
 - (1) Any massing type incorporating a gable roof form may be expressed using a hipped roof form.
 - (2) All multi-planed gable or hipped roof forms shall comply with the applicable standards for rake and eave in Subsections 7.090.6 (Rake) and 7.090.7 (Eave).
 - (3) Dormers (Subsection 7.090.12) may project above the planes defined by the primary roof form.

- (4) Vents and Ducts. All vents and ducts shall protrude:
 - (a) Behind a parapet, where present; and/or
 - (b) Within the upper half of a sloped roof and painted to match the roof surface.
 - (5) The uppermost portion of the building shall include at least one of the following:
 - (a) Parapet in compliance with Subsection 7.090.9,
 - (b) Sloped roof with eave and/or rake in compliance with Subsections 7.090.6-7, and/or
 - (c) Cornice. Cornice may be used in combination with a parapet or sloped roof.
 - (6) If one or more upper stories are stepped back from the main façade by at least 10 feet, the portion of the façade that is not stepped back shall comply with Item (5) above.
3. **Facade Proportions.** The height and width of a rectangle inscribing all corners of the main body's front elevation shall be related by one of the following ratios, within a 2% margin (see Figure 7.050.1):
 - A. A ratio of two whole numbers, each less than or equal to 9 (e.g., 3:5, 7:4);
 - B. A ratio of $1:\sqrt{2}$ ($\approx 1:1.414$); or
 - C. The golden ratio ($\approx 1:1.618$).
 4. **Local Symmetry.** The front elevation of the main body shall display at least one axis of local symmetry.
 - A. Boundaries of local symmetry shall include an entry door and/or at least two openings.
 - B. Within boundaries of local symmetry, the following elements shall be identically reflected across axis of local symmetry: eave/rake, parapet, opening boundaries, posts/columns, and brackets.

Figure 7.050.1 Façade Proportions and Local Symmetry

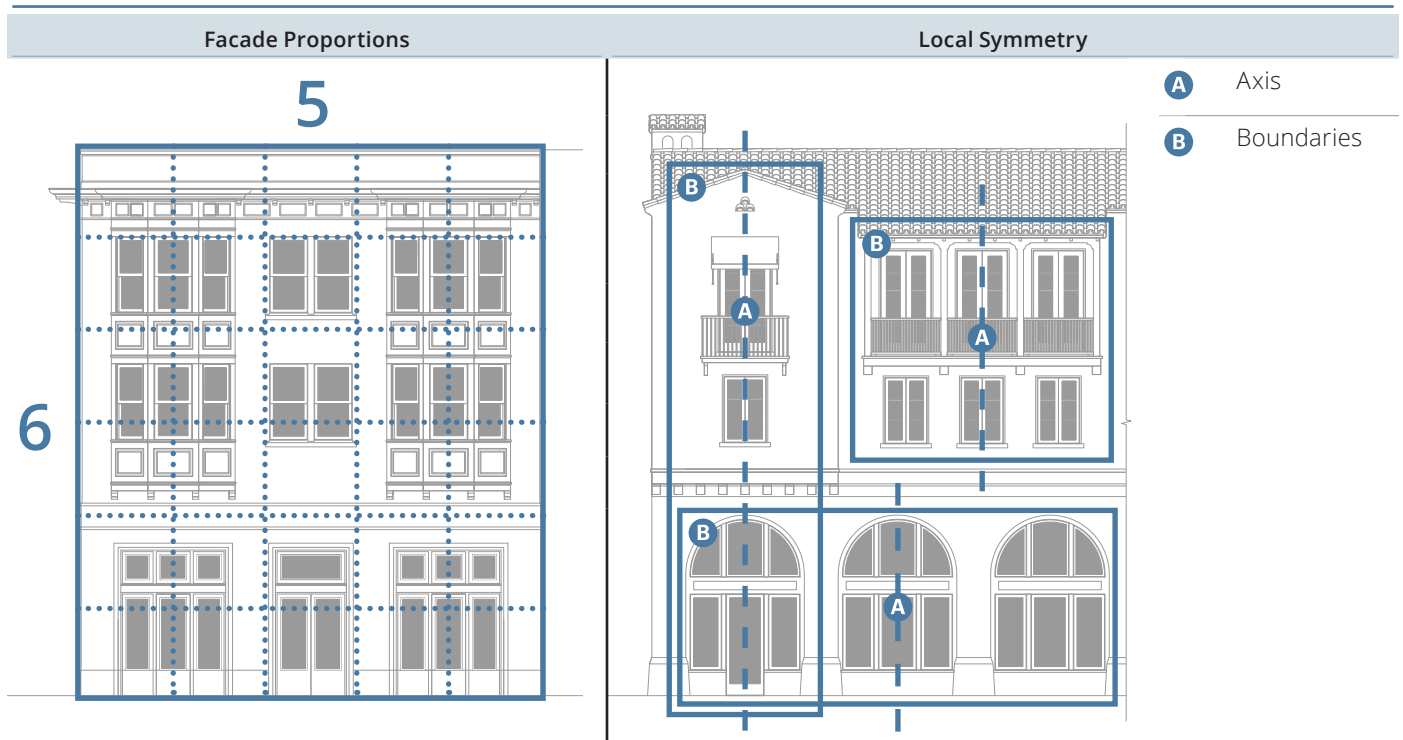
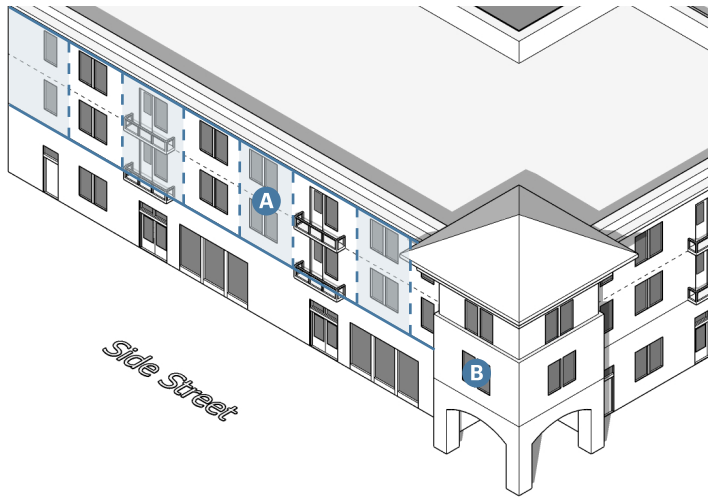

Figure 7.050.2 Example of Bay Composition



- A** 8-Bay Façade Composition
- B** Corner element is treated separately

5. **Bay Composition.** Each façade shall be arranged according to a pattern of bays. See Chapter 11 (Measurement Methods) for details on the application bays to façades.
 - A. Each bay shall be at least 4 feet wide and no wider than 17 feet; except that in the T4MS.M district, bays within the building's lowest story may be up to 25 feet wide.
 - B. Each façade segment bounded on either side by an outside corner of the building, a design site line, or a corner element shall contain at least 2 bays and no more than 9 bays.
 - C. All bays within a building shall be the same height.
 - D. Bay composition is allowed to differ between the lowest story, upper stories, and/or half-story but shall be consistent within each of these divisions.
 - E. Corner elements are exempt from the requirements of Subsections 7.050.5.A-D.
6. **Corner Parcels**
 - A. Buildings located at the intersection of at least two public rights-of-way shall incorporate at least one of the following features at the corner:
 - (1) A corner element (see Subsection 7.050.7);
 - (2) An arcade, gallery, or trellis, complying with the standards for one of the types identified in Table 7.050.A, that measures at least 6' x 6' and is oriented toward the corner (not perpendicular to the street);
 - (3) A balcony (see Subsection 7.090.14);
 - (4) ~~An art sculpture and/or fountain; and/or~~
 - (5) ~~A public or semi-public outdoor seating area (e.g., outdoor seating area for a restaurant) that is at least 1,000 square feet in area.~~

Missed Edit(s):
Delete Subsections 7.050.6.A.(4) and 7.050.6.A.(5)

7. Corner Elements

- A. Corner elements are allowed at the intersection of two or more of the following:
- (1) Public right(s) of way;
 - (2) Thoroughfare(s) as defined in Section 9.040 (General to Thoroughfares); or
 - (3) Open space as defined by Section 9.030 (General to Open Space).
- B. A corner element shall be in compliance with the following standards:
- (1) Corner element shall incorporate at least one full story.
 - (2) If corner element extends through the building's eave or parapet, it may exceed the main building façade height by at least 4 feet and up to 10 feet above the maximum height allowed by the district, for a horizontal area up to 20 feet by 20 feet.
 - (3) If corner element extends through the building/module's lowest story, it shall contain a ground-floor entrance oriented toward the corner (not perpendicular to the street).
 - (4) A corner element may project from the main façade by up to 4 feet. Projections over the right of way are not allowed.
 - (5) Corner element shall use one of the profile types shown in Figure 7.050.3:

Figure 7.050.3 Corner Element Profiles

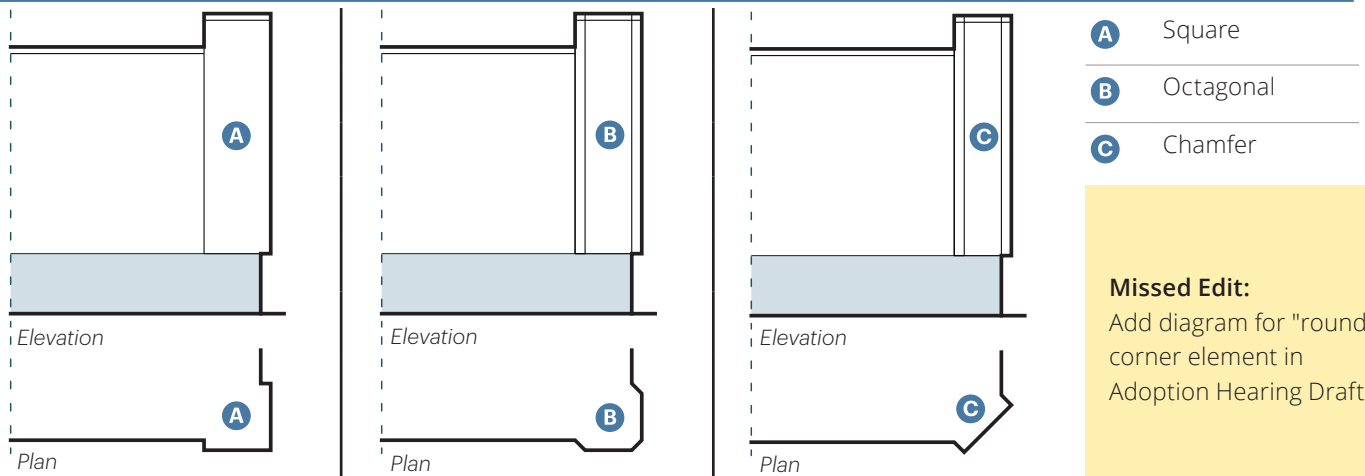

8. **Architectural Open Space.** Any habitable outdoor space supported by the building structure, including occupiable balconies (see Subsection 7.090.14), shall either be uncovered or sheltered according to one of the patterns in Table 7.050.A (Architectural Open Space Types).

Table 7.050.A: Architectural Open Space Types

Pergola



This type shall include posts and beams supporting a semi-open roof structure or lattice.

Posts shall be no narrower than 3.5 inches or 1/20 of the unbraced post length, whichever is greater.

Post and Beam



This type shall include posts and beams connected by brackets and supporting a full floor/roof structure.

Posts shall be no narrower than 3.5 inches or 1/20 of the unbraced post length, whichever is greater.

The distance between posts shall be no wider than the total post height.

Arched Openings



Arched openings shall be bounded by columns, piers, or sections of solid wall supporting a full floor/roof structure.

The ratio of column diameter at lowest part of shaft to column height shall be no less than 1:10 and no greater than 1:7.

Width of wall sections or piers at outside corners shall be no less than 1/3 of the opening width. Piers between multiple arched openings may be narrower.

Rectilinear



This space type shall be bounded by square/rectangular piers framing rectilinear wall openings and supporting a full floor/roof structure..

If lintels are expressed on the façade, they shall extend over the piers by half the lintel height at each end.

Piers shall be no narrower in any dimension than 15.5 inches or 1/6 of the opening width, whichever is greater.

Piers at corners shall be wider than piers between openings.

Textile Shading



This space type shall be shaded by fabric elements, such as awnings or stretched canvas, secured to the building structure.

Sheltered by Main Roof Form



This space type shall be covered by a roof supported by other building volumes.

7.060 Bird Safety

1. Bird safety treatment is required on curtain wall buildings in compliance with the following:
 - A. Glazed areas within 10 feet of a building corner for non-residential uses;
 - B. Glazed areas within 15 vertical feet and 20 horizontal feet of any landscaped area, including green roofs and vegetated courtyards;
 - C. Parallel panes of glass separated by 30 feet or less, with no intervening walls;
 - D. Any transparent atrium, free-standing glass feature, or architectural glass element that projects from the building mass;
 - E. Glazed areas within 60 feet of grade in a façade with more than 20 percent glazing located within 300 feet of any water body, or within 100 feet of a landscaped area or open space larger than one acre.
2. ~~Mirrored glass and glazing with a reflective index greater than 20 percent are prohibited on building façades.~~

Missed Edit(s):

1. In Subsection 7.060.1, added text to end of sentence "...curtainwall buildings in compliance with the following:"

2. Delete Subsection 7.060.2

7.070 Durability

1. Exterior timber shall be protected from decay by at least one of the following:
 - A. Staining and sealing;
 - B. Painting; and/or
 - C. Material properties. Pressure treated lumber is not allowed as a façade finish material. The following types of unpainted wood are allowed:
 - (1) ~~Teak~~
 - (2) Cedar
 - (3) Redwood
 - (4) Mahogany
 - (5) White Oak
 - (6) ~~Ipe/Brazilian Walnut~~
 - (7) Bald Cypress
 - (8) Black Locust
2. Exterior ferrous metals shall be protected from corrosion by at least one of the following:
 - A. Painting or other impermeable coating; and/or
 - B. Metallurgical properties. The following types of metal are allowed:
 - (1) Galvanized steel
 - (2) Stainless steel
 - (3) Weathering steel (e.g., COR-TEN)

Missed Edit(s):

Delete Teak and Ipe; numbering will be updated in Adoption Hearing Draft

Missed Edit(s):
Delete Privacy Standards; Update Section numbers/references as necessary in Adoption Hearing Draft

7.080 Privacy Standards

1. ~~Intent. These standards are designed to provide privacy between primary living spaces of buildings on each side of a lot line where side setbacks are required or provided where not required. Windows and balconies along the side of a building within 20 feet of an interior side lot line in all districts are subject to these standards.~~
2. ~~Standards~~
 - A. ~~Primary living spaces adjoining an interior side setback shall be designed to either:~~
 - (1) ~~Orient principal/main windows/glazed openings toward the front and rear of the building, away from interior side lot lines; or~~
 - (2) ~~Set the window/glazing openings:~~
 - (a) ~~Perpendicular to interior side lot lines; or~~
 - (b) ~~More than six feet from interior side lot lines~~
 - B. ~~Windows within 6 feet of an interior side lot line shall either:~~
 - (1) ~~Have a minimum sill height of 44 inches; or~~
 - (2) ~~Place the window at an angle of at least 30 degrees, measured perpendicular to the adjacent side lot line.~~
 - C. ~~Balconies are prohibited within 6 feet of an interior side lot line.~~

Figure 7.060.1: Sill Height Standards along Interior Side Lot Line

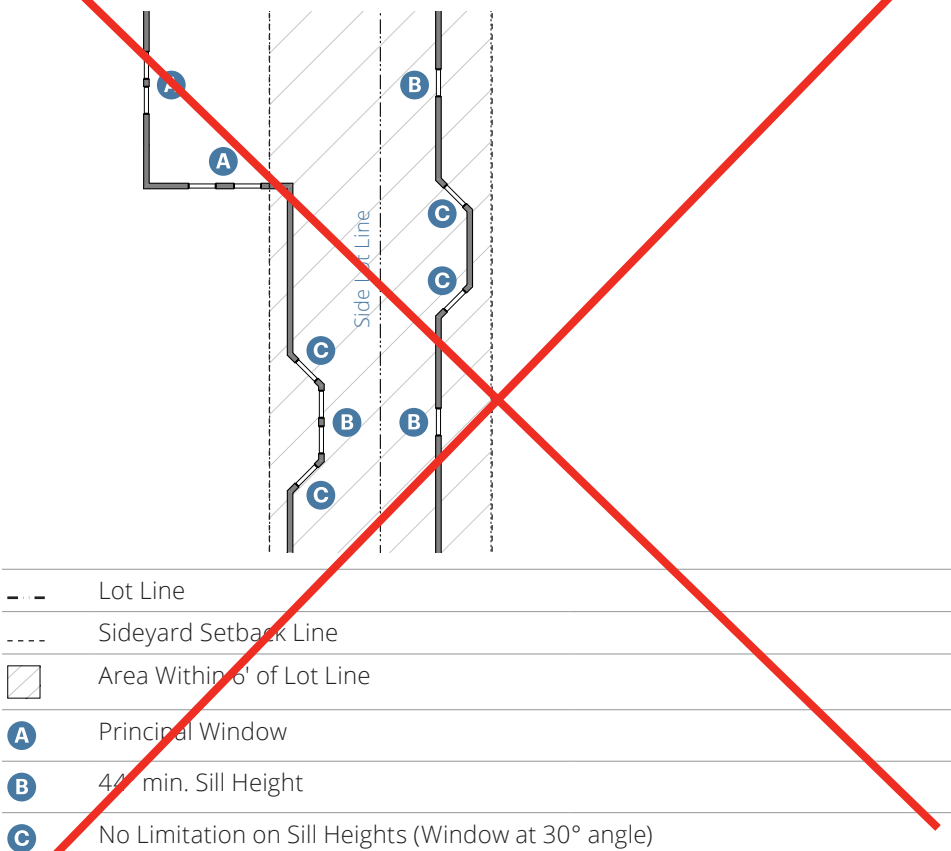

This page intentionally left blank

Missed Edit:

In Adoption Hearing Draft, footnote numbering will be updated to be in a continuous sequence in this Section 7.090

7.090 Standards for Architectural Elements



General note: The images above and the descriptions in Subsections 1 and 2 below are intended to provide a brief overview of the architectural style and are descriptive, not regulatory.

1. Applicability

The standards in this Section apply to each architectural element wherever it appears on a new building or facade renovation.

Individual element types (e.g., balconies, storefronts) or components (e.g., cornice, brackets) may be included or omitted on any given facade, but where included shall ~~meet the~~ comply with the stated nominal dimensional standards in this Section.

Elements and components are required only where explicitly indicated.

2. Style-Neutral Standards

The standards in this Section are applied independently of architectural style. Diagrams are for illustrative purposes only and do not constrain the expression of listed elements with respect to style. Only aspects keyed to standards listed in the tables are regulated.

Missed Edit:

Replaced text "meet the" with "comply with the stated nominal dimensional"

Architectural Elements – House-Scale Example

Note: The image below is intended to provide a reference for architectural elements and is illustrative, not regulatory. It is not an exhaustive list of applicable standards.

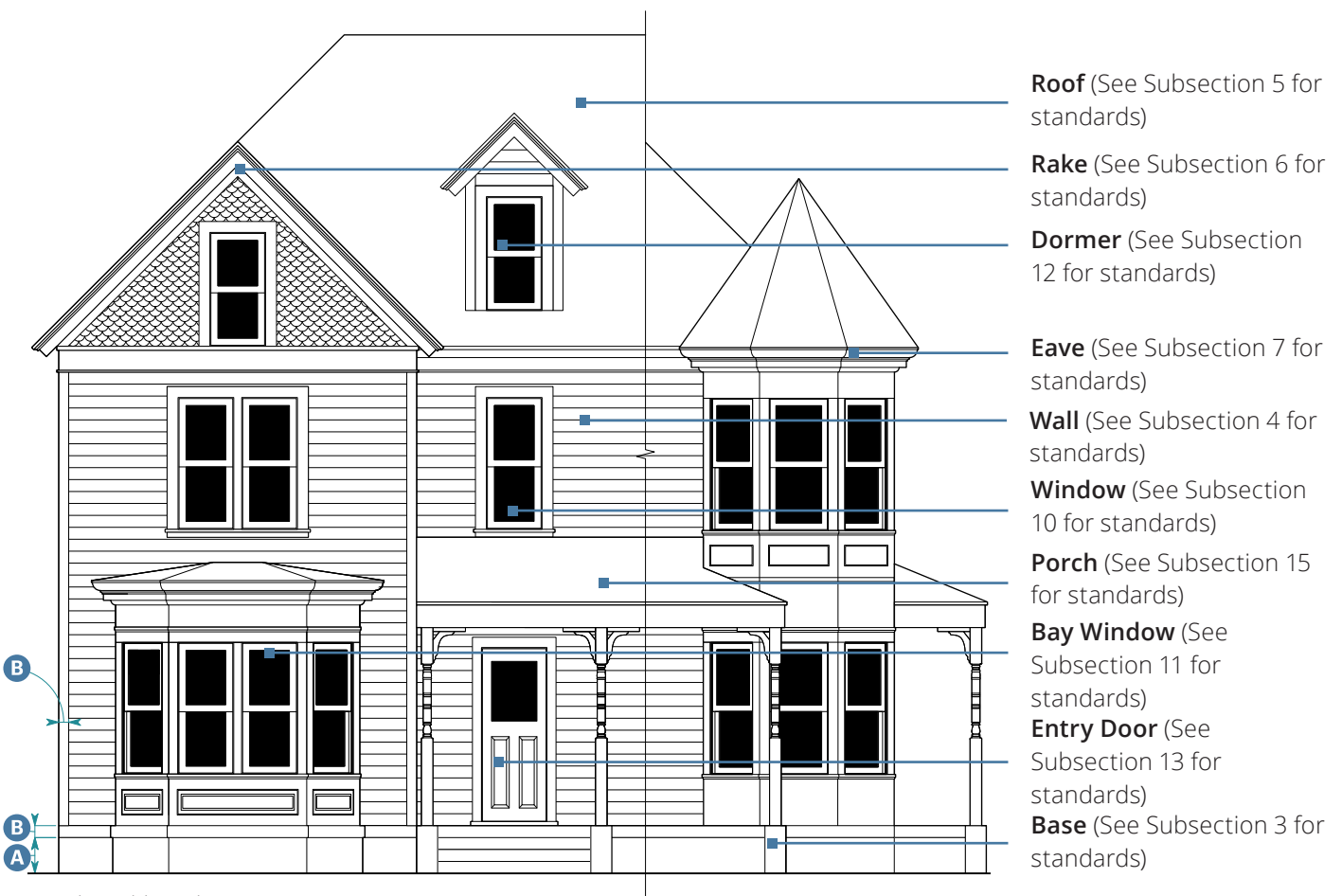

Example Building Elevation

3. Base	
Height	1'0" min.; 1/2 story max. A

Missed Edit(s):
Delete standard for wall trim width; lables in table and diagram to be updated in Adoption Hearing Draft

4. Wall	
Trim 1	
Width	2" min. B
Half-Timbering Trim	
Width	10" min.

~~1-Corner trim required only on buildings with wood, composite wood, or cementitious siding wall material.~~

Architectural Elements – Block-Scale Example

Note: The image below is intended to provide a reference for architectural elements and is illustrative, not regulatory. It is not an exhaustive list of applicable standards.

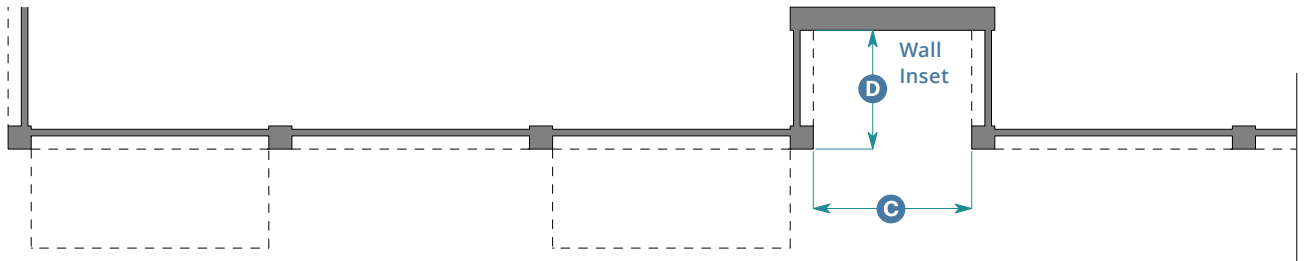

Prototypical Building Plan, Primary Facade

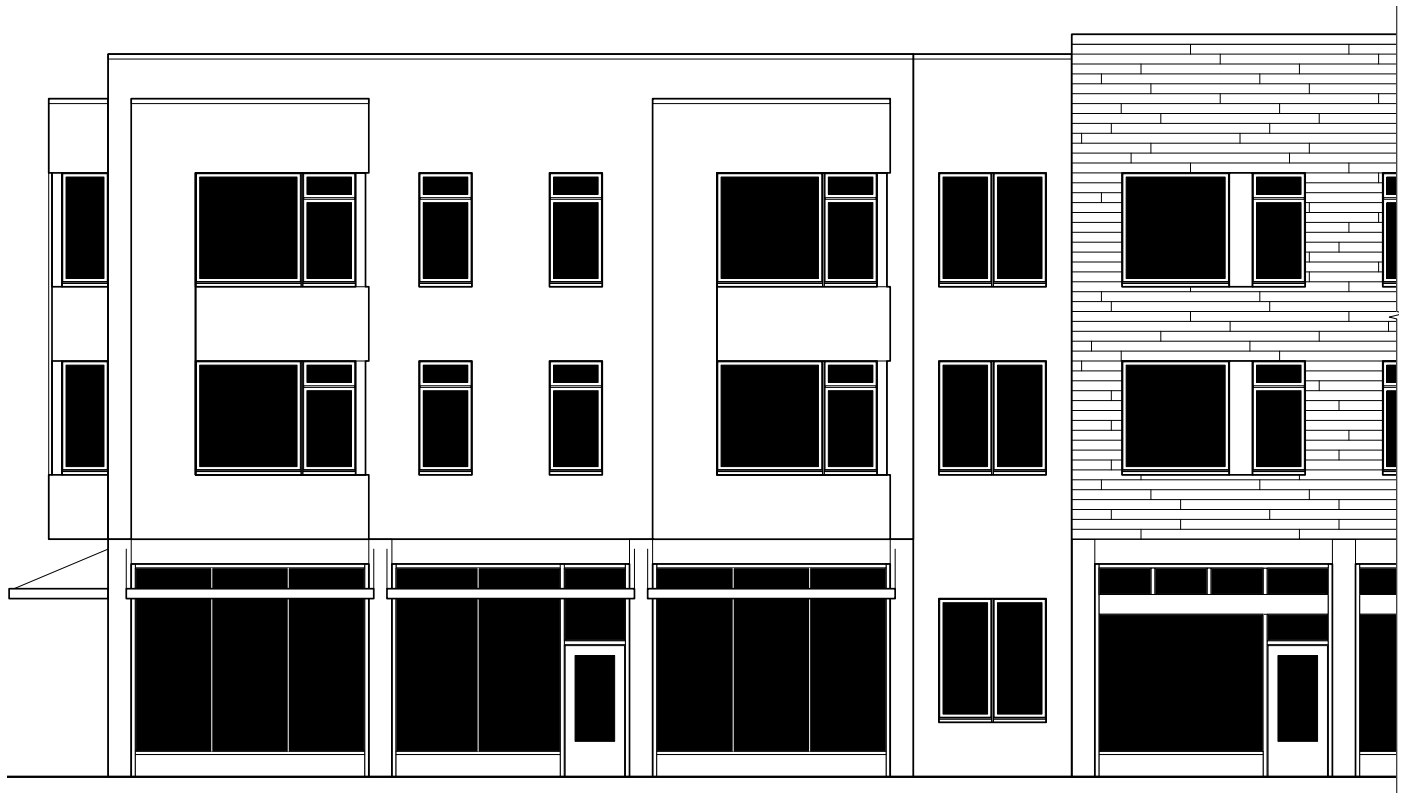

Example Building Elevation

4. Wall (Continued)
Wall Inset
 A wall inset from the primary facade is required for buildings greater than 75' in width.
 Wall inset shall be continuous for the full height of the building.
 Roof and wall projections may encroach into wall inset.

4. Wall (Continued)
 Wall Inset Dimensions

Width	8'0" min.; 12'0" max.	C
Depth	6'0" min.	D

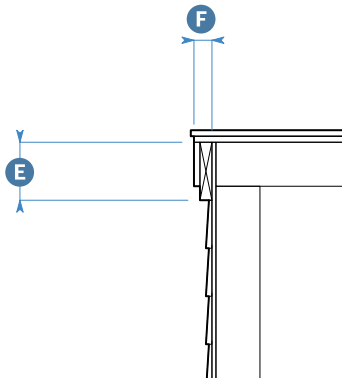

Closed Rake Section

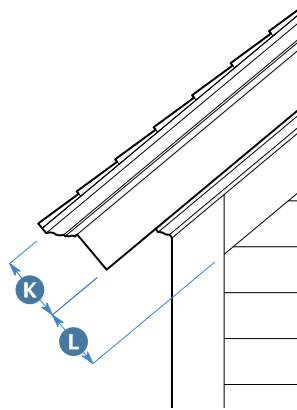

Open Eave Elevation (Gable)

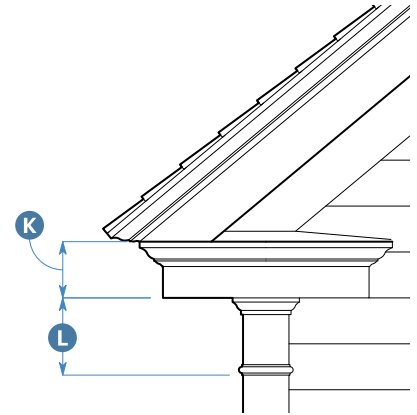

Returned Eave Elevation (Gable)

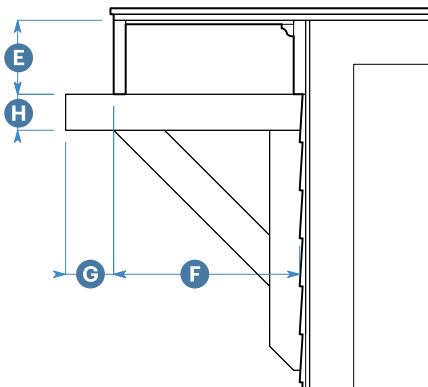

Open Rake Section

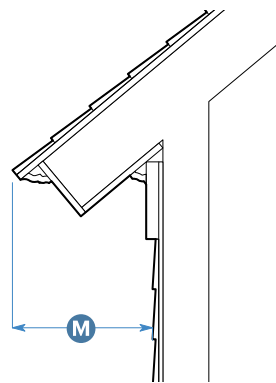

Open Eave Section

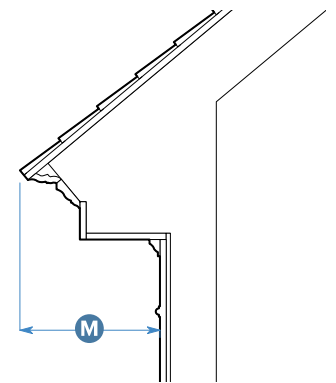

Returned Eave Section

5. Building Roof		
Building Roof Standards	Sloped Roof	Flat Roof
Applicable Subsections		
Subsection 6 (Rake)	A	N/A
Subsection 7 (Eave)	A	N/A
Subsection 9 (Parapet)	N/A	A
Form		
Pitch	2:12 min.	N/A

6. Rake		
Height		
See Subsection 7 (Eave) for height standards. E		
Horizontal Projection		
	Closed	Open
Projection to Fascia	No min.; 2" max.	8" min.; 3'0" max.; F
Bracket Projection Beyond Fascia	N/A	No min.; 1'0" max. G
Bracket Bracing Member		
Height	4" min.	H

A = Applicable N/A = Not Applicable

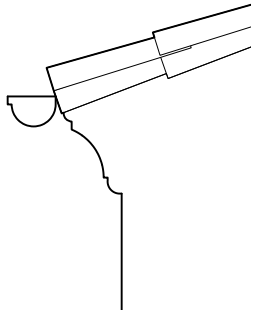

Closed Eave Elevation (Gble)

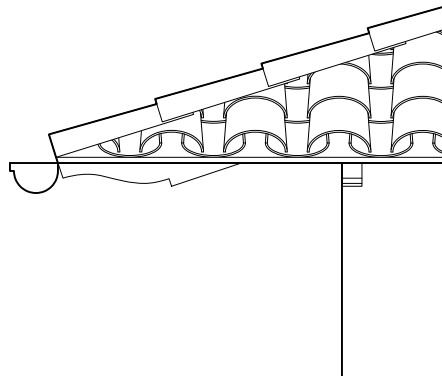

Open Eave Elevation (Hipped)

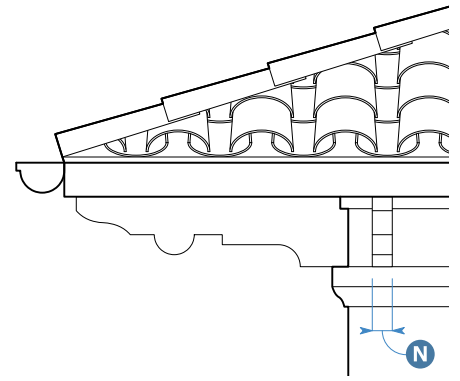

Returned Eave Elevation (Hipped)

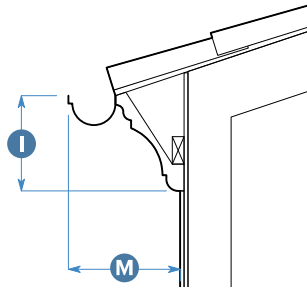

Closed Eave Section

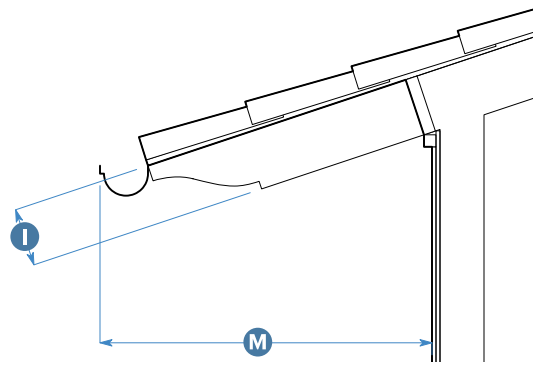

Open Eave Section

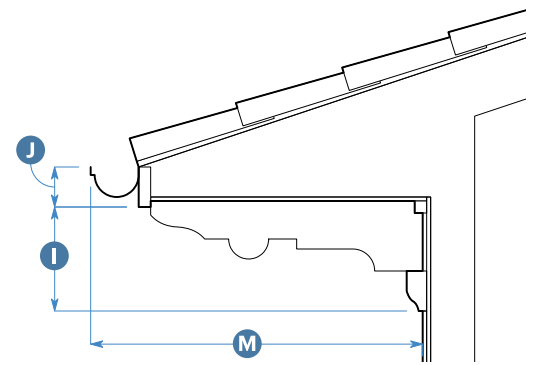

Returned Eave Section

7. Eave				
Standards	Closed	Open	Returned	
Height				
Supporting Element	1'0" min.	8" min.	10" min.	I
Fascia Alone	No min.	No min.	6" min.	J
Molding and Fascia	No min.	8" min.	8" min.	K
Trim Band	10" min.	10" min.	10" min.	L
Horizontal Projection ¹				
Overall	1'0" min.	1'0" min.	1'0" min.	M
Brackets				
Width	3" min.			N
Spacing	24" max. on center			
Placement	Below fascia			

¹Horizontal projection includes gutter.

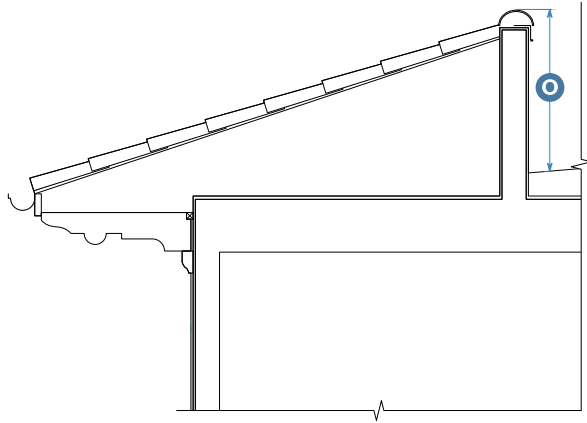

Sloped Roof with Parapet Section

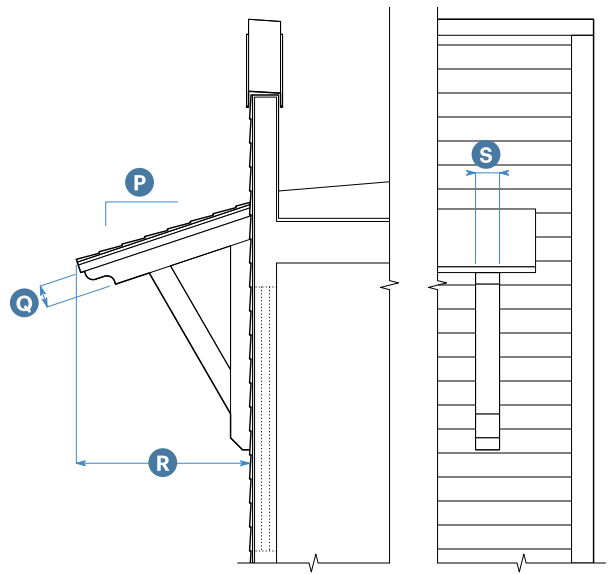

Parapet Section

Parapet Elevation

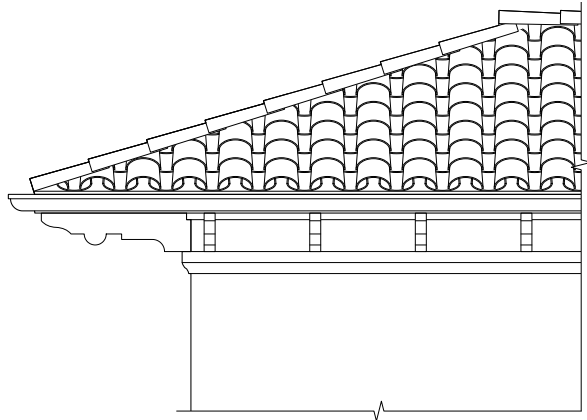

Sloped Roof with Parapet Elevation

7. Eave (Continued)

Sloped Roof with Parapet

Parapet Height 30" min. O

Parapet height shall exceed height of roof-mounted equipment.

8. Canopy

Canopy

Roof Pitch 3:12 min. P

Eave Height 6" min. Q

Horizontal Projection³ 3'0" min. R

Bracket Width 4" min. S

³Horizontal projection includes gutter.

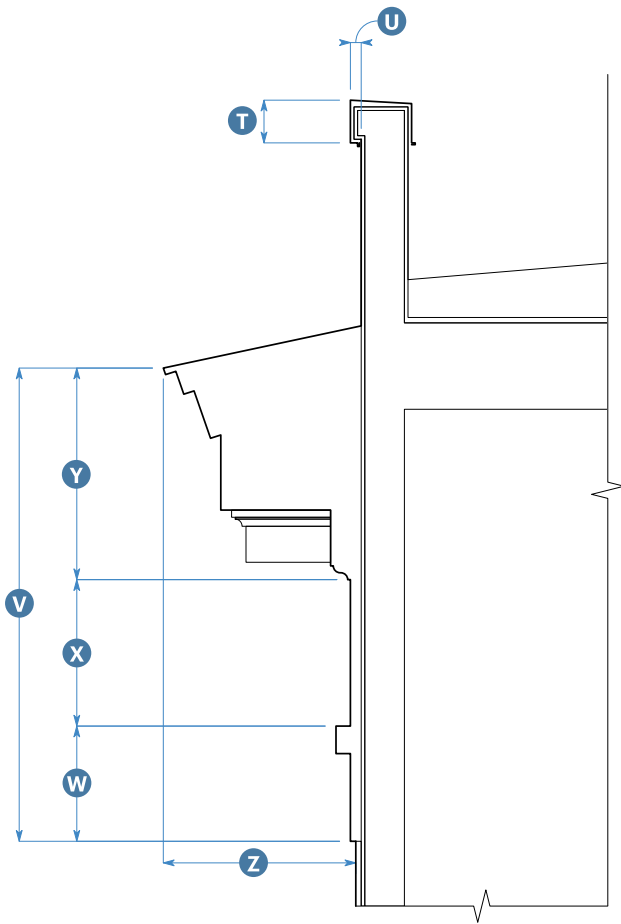

Parapet Section

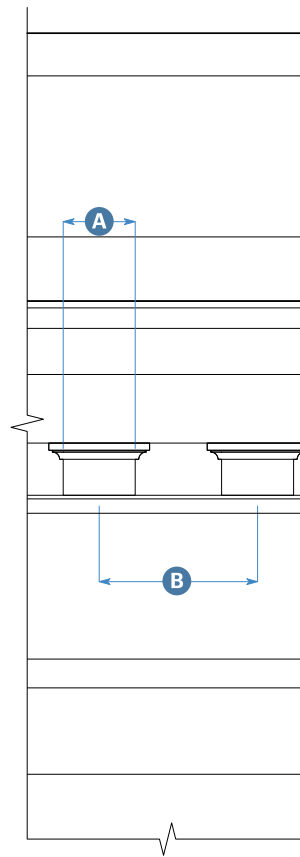

Parapet Elevation

9. Parapet

Parapet Cap (Required)

Height	0" min.; 6" max.	T
Projection	0" min.; 3" max.	U

9. Parapet (continued)

Entablature

Height		
Overall	5'6" min.	V
Architrave	1'2" min.	W
Frieze	1'2" min.	X
Cornice	1'9" min.	Y

Horizontal Projection ¹

Overall	1'9" min.	Z
---------	-----------	---

Dentils

Width	10" min.	A
Spacing	2'0" max. on center	B
Placement	Above bed molding at bottom of cornice/top of frieze	

¹Horizontal projection includes gutter.

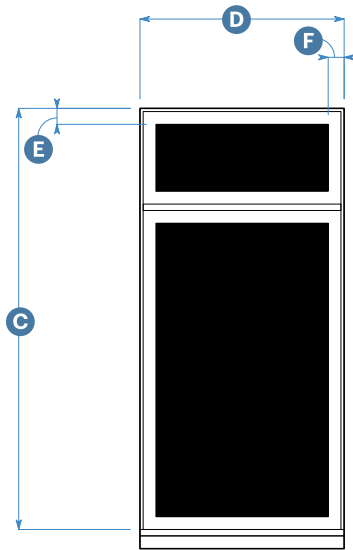

Upper Floor Typical Window Elevation

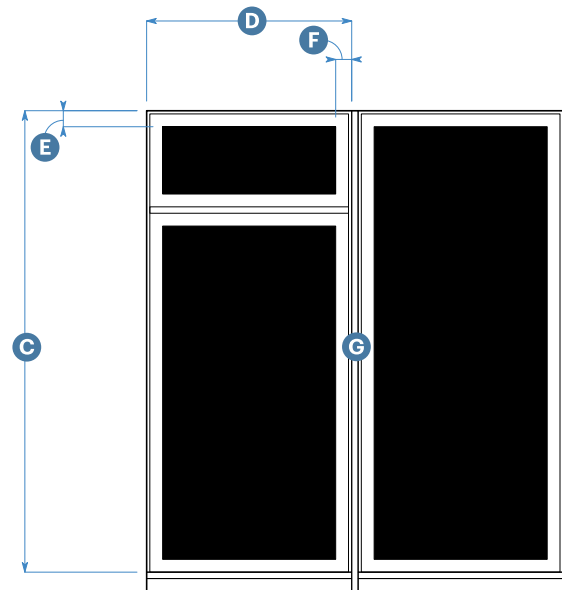

Ground Floor Ganged Window Elevation

10. Windows

Opening Proportion, Height C to Width D

Typical Window⁷

Ground Floor	2.0 min.
Typical Upper Floor	1.5 min.

Accent Window

Rectangle	1.5 min. (2'6" max. width)
Square	1.0 min. (3'0" max. width)

Ganged Window⁸ 0.6 min.

Picture Window 1.1 min.

Dormer Window 1.75 min.

⁷ "Typical" refers to a regular recurring window (i.e., size or lite pattern) on a facade.

⁸ Ganged windows may be composed of multiple typical windows, of which one typical window may be replaced with a picture window.

10. Windows (Continued)

Window

Operation Double-Hung, Single-Hung, Awning, Casement, Fixed

Sash Width

Rail	2" min.	E
Stile	2" min.	F

Glazing divisions shall be positioned exterior to glass panes.

Mullions

Mullions required between ganged windows. **G**

¹ Windows with width greater than their height shall be ganged with vertically-oriented windows or doors.

² Picture windows shall be wider than typical windows and equal in height to windows on the same floor.

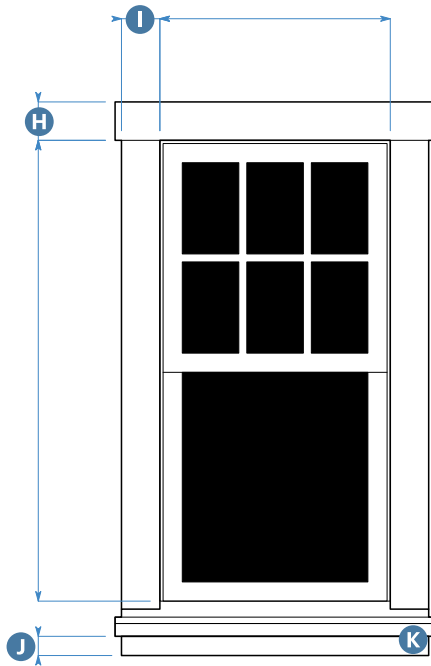

Window With Surround

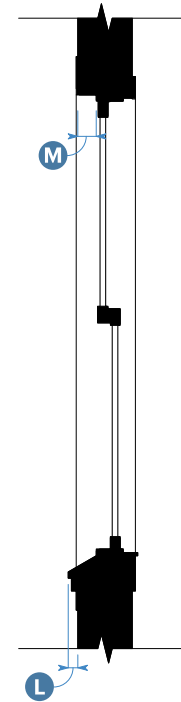

Window Section

Missed Edit(s):

Updated window head and jamb trim width

10. Windows (Continued)

Surround

Requirements with Siding or Shingle Finish Material

Trim Widths

Head	23.5" min.	H
Jamb	23.5" min.	I
Apron	3" min.	J

Requirements with Masonry Finish Material

Window openings surrounded by masonry finish materials shall be spanned by a lintel or arch.

Lintel

Height	1/8 of opening width, min.	H
Extension Beyond Sides of Opening	1/2 lintel height, min.	

Within an arch, all joints shall align with a common point on the opening's center line. Where expressed, the keystone shall be centered on the opening's center line. Vertical joints along the center line are not allowed.

10. Windows (Continued)

Sill⁴

Extension Beyond Sides of Opening	1/2 of sill/apron height min.	K
Projection from Wall Finish Surface	1" min.	L
Slope (Toward Exterior)	1:12 min.	

Window Frame Recess from Wall Finish Surface

Punched Openings	2" min.	M
All Other Windows	No min.	

⁴Required only for windows or groups of windows within punched openings



Bay Window Plan

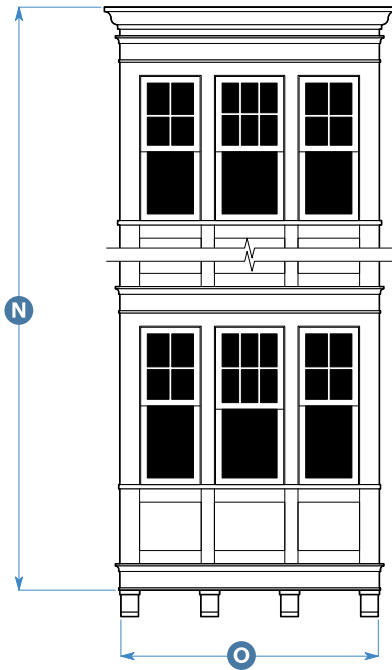

Bay Window Elevation

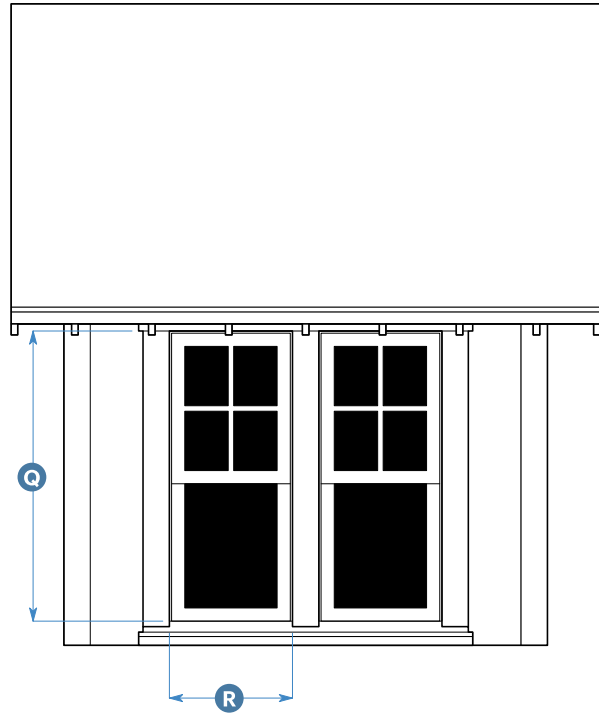

Dormer Elevation

11. Bay Windows	
Form	
Allowed Profiles	Square, Chamfered
Interior Angle for Chamfered Profile	30 degrees min.; 60 degrees max.
Number of Faces	3min.; 5 max.
Size	
Height	N
On buildings with heights up to 3 stories	2 stories max.
On buildings with heights above 3 stories	2 stories plus 1 additional story for each building story over 3 max.
Width	6'0" min.; 12'0" max. O
Depth	1'0" min.; 3'0" max. P
Allowed Eave/Cornice Treatments	
A. Building parapet/eave/cornice wraps bay.	
B. Bay has its own eave/cornice below building eave/cornice.	
C. Bay returns into building eave/cornice (bay never projects above the building eave/cornice).	

11. Bay Windows (Continued)	
Additional Standards	
Bay depth not allowed to project beyond eave/cornice depth.	
Multi-story bay window form shall be vertically continuous.	
Any continuous horizontal articulation shall wrap bay form.	
Corner bay may be rotated 45 degrees from building corner.	
12. Dormers	
Roof Form	
Allowed Roof Forms	Shed, Gable
Pitch	2:12 min.
Horizontal Projection	
Eave	8" min.
Rake	8" min.
Window	
Proportion, Height to Width	1.75 min. Q to Width R
Width	2'8" min. R
Dormers allowed only for buildings with half stories.	
See Subsections 6 (Rake), 7 (Eave), and 10 (Windows) for additional standards.	

Missed Edit(s):

Deleted bay height standard (3-story bay window allowed); Standard to be added to allow bay window to extend as low as the finished ground floor when behind the ROW.

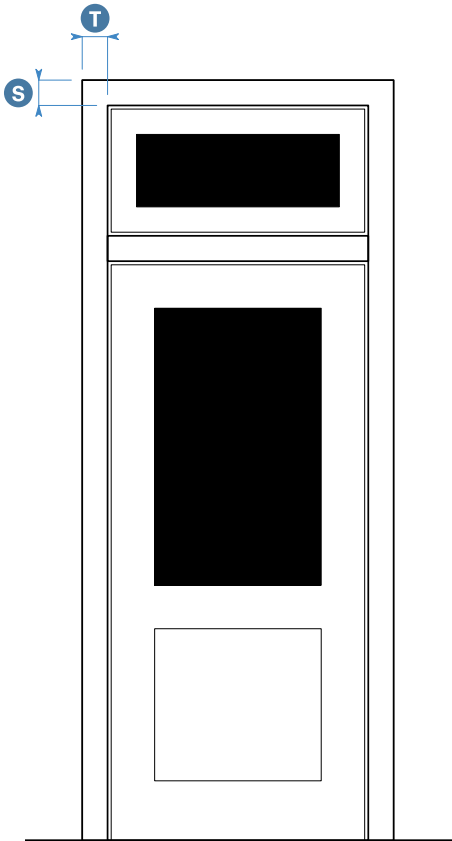

Entry Door Elevation

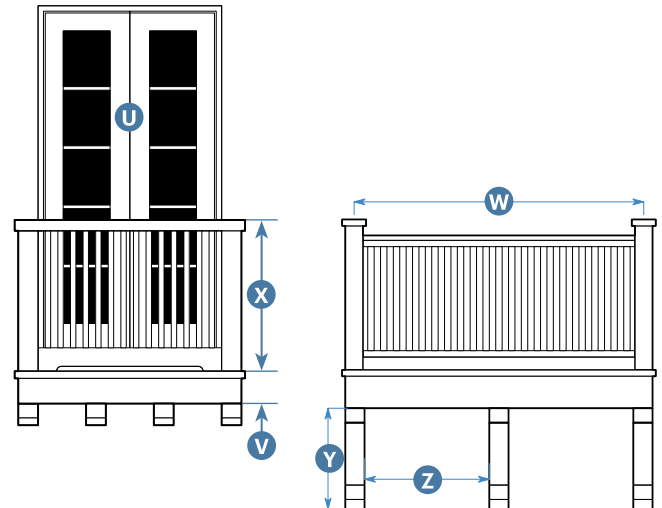

Juliet Balcony Front Elevation

Occupiable Balcony Front Elevation

13. Entry Doors	
Door	
Number of Panels	2 min. ¹
Surround	
Head Width	4" min. S
Jamb Width	4" min. T
Additional Elements	
Transom	Allowed
Pediment	Allowed

¹ No panels required for full lite doors.

Missed Edit(s):
 Added footnote 1; footnote numbering to be updated in Adoption Hearing Draft

14. Balconies	
Allowed Types	
Type 1 - Juliet Balcony	
Inward-swinging doors with full glazing required	U
Base Height (Required)	3" min. V
Base Projection (Required)	4" min.
Type 2 - Occupiable Balcony	
Depth	6' min.
Area	48 sq ft min.
Recess into Facade	54" max.
Overall Width	10'0" max.
Width Between Posts	3' min. on center W
Guard/Railing (Required)	
Height	Per Building Code X
Brackets	
Depth	80% of projection depth at bracket, min.
Height	50% of bracket depth, min. Y
Spacing	6' on center, max. Z

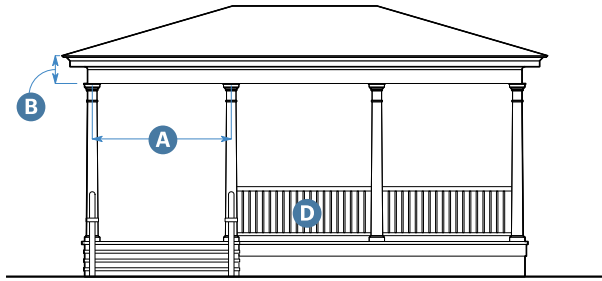

One-Story Porch

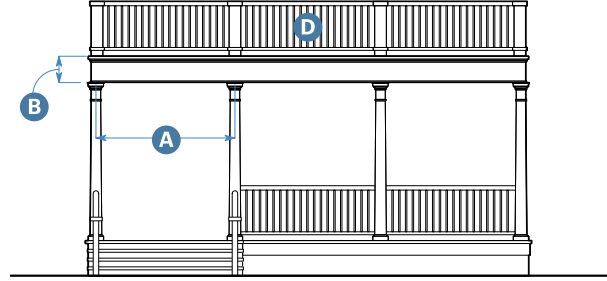

One-Story Porch with Deck Above

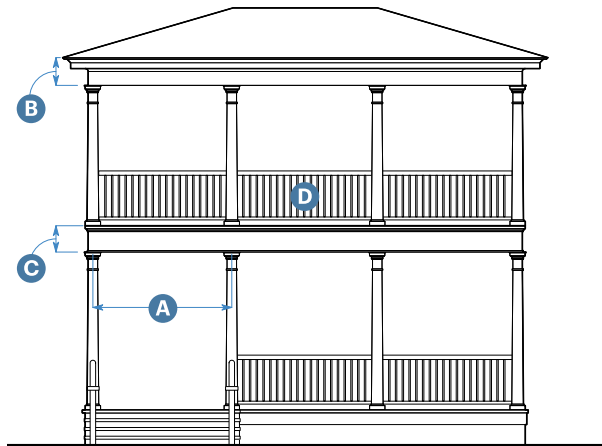

Two-Story Porch

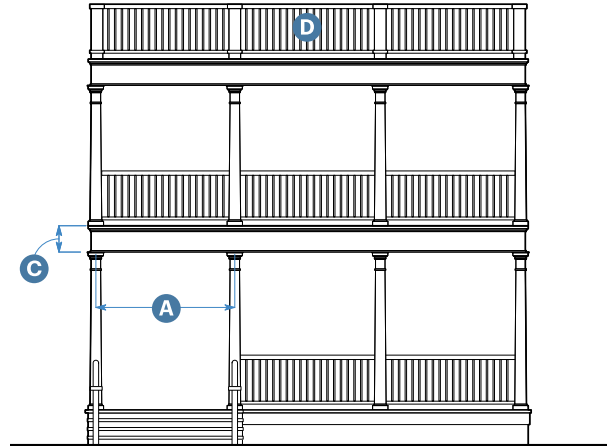

Two-Story Porch with Deck Above

15. Porches and Galleries	
Posts/Columns	
Width/Diameter	6" min.; 4" min. for steel section
Spacing	12' max. on center A
Entablature	
Height of Topmost Entablature	
Overall	1'6" min. B
Fascia	10" min.
Height of Floor-to-Floor Entablature	
Overall	10" min. C
Guard/Railing	
Height	Per Building Code D

Missed Edit:
 Added standard for width of steel section post/column



Storefront Elevation

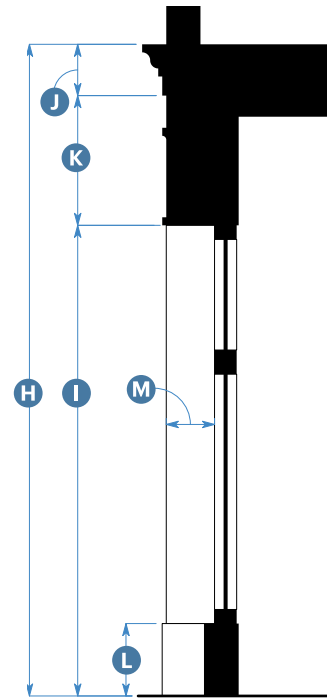

Storefront Section

16. Storefronts

Width

Storefront Module	10'0" min.; 15'0" max.	E
Display Window	3'0" min.; 4'0" max.	F
Distance Between Storefront Modules	1'0" min.; 2'6" max.	G

Height

Overall	13'0" min.	H
Head Height	10'0" min.	I
Cornice	9" min.	J
Signage Band	1'6" min.	K
Base (if used)	1'0" min.; 2'0" max. ¹	L

Horizontal Recess

Depth	6" min.; 2'0" max.	M
-------	--------------------	----------

Base shall be continuous, unless divided by pilaster, and align with base height of building (if any).

Cornice shall be continuous.

¹4'0" max. for Maker Shopfront

Missed Edit(s):

1. Added text "(if used)" after Base
2. Delete min. standard for Storefront Base Height
3. Added footnote 1; footnote numbering to be updated in Adoption Hearing Draft

17. Materials	
Element	Allowed Materials
Wall	
Wall Cladding	Wood, composite wood, fiber cement, brick, stone, stucco, metal panel, cast-in-place concrete
Base	
Base or Foundation	Brick, stone, cast stone, tile, wood, composite wood, fiber cement, stucco, concrete
Roof and Roof Elements	
Roofing	Asphalt shingles, wood shingles, slate, standing seam metal, clay tiles, nonreflective solar tiles
Rake and Eave	Wood, composite wood, stucco, metal
Cornice	Wood, composite wood, stucco, fiberglass
Brackets	Wood, composite wood, fiberglass
Gutter	Metal ogee, half-round, or box
Windows, Bay Windows, and Entry Doors	
Lintel	Stone, concrete
Trim or Surround	Composite wood, wood, fiber cement
Entry Door	Wood, aluminum-clad wood, aluminum, fiberglass, composite wood, steel
Window Frames	Wood, aluminum clad wood, aluminum, vinyl, fiberglass
Window Sill	Wood, composite wood, fiber cement, stucco, cast stone
Glazing ⁵	Clear or frosted glass; shall not be tinted, mirrored, or colored
Balconies	
Guard/Railing	Metal, wood, composite wood, glass
Fascia	Metal, wood, composite wood
Porches, Galleries, and Pergolas	
Columns/Posts and Beams	Wood, composite wood, fiberglass, cast stone, metal
Guard/Railing	Metal, wood, composite wood, glass

17. Materials (Continued)	
Element	Allowed Materials
Arched Openings	
Columns, Archivolts, and Imposts	Cast stone, fiberglass, stucco
Storefronts	
Storefront	Wood, composite wood, metal
Columns	Wood, composite wood, fiberglass, metal
Storefront Base	Wood panels, brick, stone, cast stone, tile, fiber cement, stucco, concrete

Masonry Finish Materials

Where brick appears as a finish material, it must extend vertically to the upper boundary of the base, if present, or to grade.

Where stone appears as a finish material, it must extend vertically to grade.

Material and Color Changes

Changes in wall finish material ~~or color~~ shall occur at inside corners rather than outside corners.

Allowed Colors⁵

Primary Color 50% of façade min.

Secondary Color 45% of façade max.

Tertiary Color 20% of façade max.

Accent Color Trim and architectural details

~~5 Materials with intrinsic, naturally occurring-occurring coloration are not subject to these limits and may be used anywhere on the façade. Painted materials and materials with prefinished color are subject to these limits.~~

⁵ Reflectivity index shall be less than 20%

Missed Edit(s):

1. Delete all standards regulating color
2. Added footnote 5

Chapter 8: Specific to Signage Types

Sections:

8.010	Purpose
8.020	Sign Types
8.030	Overview of Sign Types
8.040	Yard/Porch Sign
8.050	Projecting Sign
8.060	Awning/Canopy Sign
8.070	Wall Sign
8.080	Painted Wall Sign
8.090	Window Sign
8.100	Sidewalk Sign
8.110	Directory Sign

8.010 Purpose

1. This Chapter provides standards to ensure that all signs are compatible with the intended physical character, and in compliance with all applicable plans of the City.
2. The purpose of this Chapter is to promote public health, safety, and welfare through a comprehensive system of reasonable, effective, consistent, content-neutral, and nondiscriminatory sign standards to:
 - A. Balance public and private objectives by allowing adequate opportunities for effective messaging;
 - B. Protect property values and improve the local economy and quality of life by preserving and enhancing the appearance of the streetscape; and
 - C. Provide clear and unambiguous sign standards that generate signage that is consistent with the intended physical character of each district.

8.020 Sign Types

1. The allowed sign types are listed in Table 8.030.A (Sign Types Overview), together with the permit required for each sign type in each district. Table 8.030.A (Sign Types Overview) includes references to the applicable standards for each sign type.
2. Any sign type allowed in Table 8.030.A (Sign Types Overview) may be established on any design site within the district, subject to a Sign Permit in compliance with Section 17.120.020 (Permits, Fees, and Exceptions).
3. A sign type that is not listed in Table 8.030.A (Sign Types Overview) is not allowed.
4. Each sign type is coordinated with the allowed private frontage types in each district which may have additional standards to further calibrate each sign type for its context.

8.030 Overview of Sign Types

1. Table A (Sign Types Overview) provides an overview of the allowed sign types in each district.

Sign Type	Specific Standards	Districts			
		T3	T4		
		NE	N.S	MS.S	MS.M
Yard/Porch Sign	8.040	---	P	P	---
Projecting Sign	8.050	---	O	P	P
Awning/Canopy Sign	8.060	---	O	P	P
Wall Sign	8.070	---	O	P	P
Painted Wall Sign	8.080	---	---	P	P
Window Sign	8.090	---	O	P	P
Sidewalk Sign	8.100	---	O	P	P
Directory Sign	8.110	---	O	P	P

Key P = Allowed O = Allowed Only in Open Sub-District or Secondary Front Yard --- = Not Allowed

This page intentionally left blank

8.040 Yard/Porch Sign



Example of a Yard Sign



Example of Porch Sign near the building entrance



Example of a Yard Sign

1. Description

This sign is mounted on a porch or in a setback between the public ROW and the building facade. This type is pedestrian scaled and intended to be read from the sidewalk.

General Note: Photos on this page are illustrative, not regulatory.

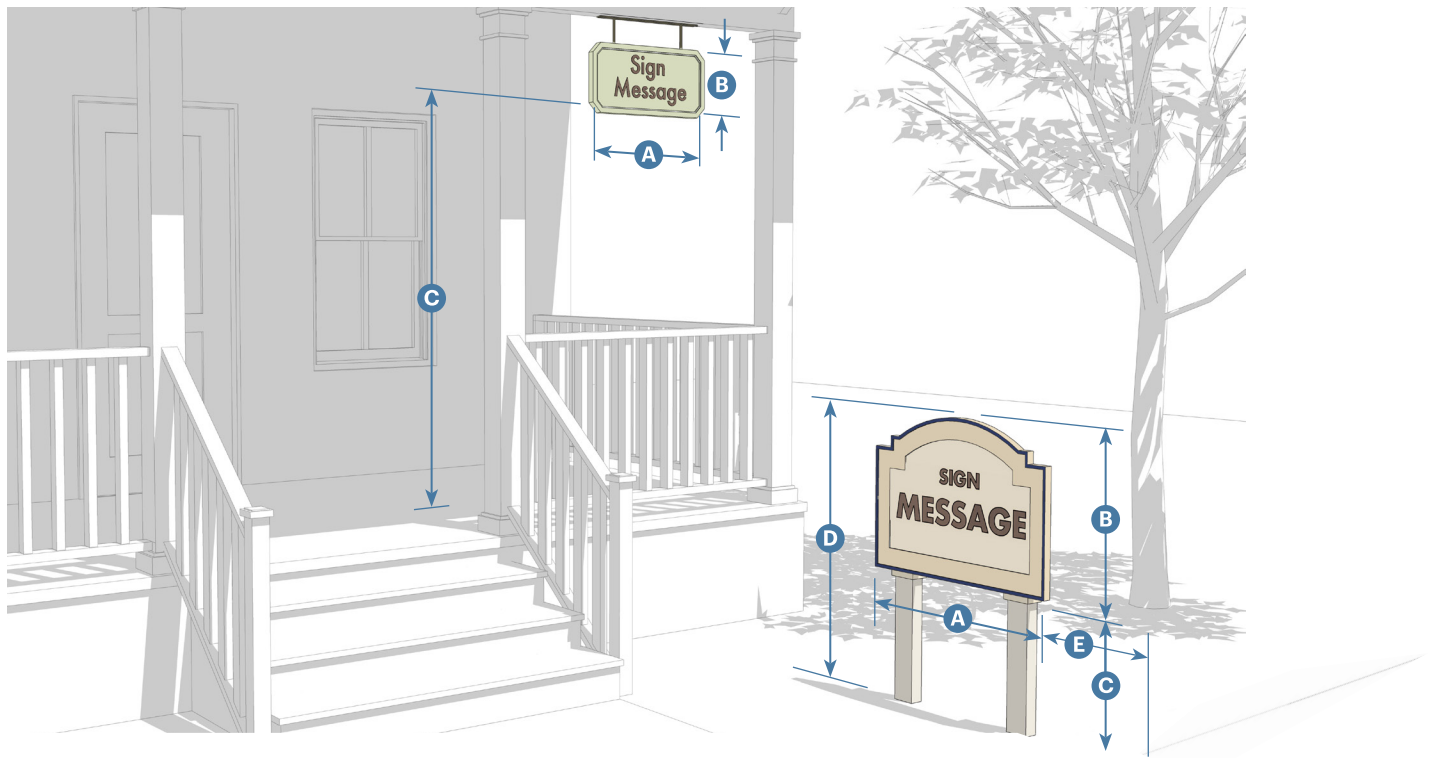

2. Sign Size

Signable Area	6 sf max.	
Width	36" max.	A
Height	36" max.	B

3. Location

Clear Height		C
Mounted on Porch	6'8" min.	
Mounted in Yard	12" min.	
Overall Height		D
Mounted in Yard	5' max.	
Distance from Sidewalk	24" min.	E

Yard/Porch Signs are not allowed within the public ROW.

Yard-mounted signs shall be parallel or perpendicular to the ROW.

8.050 Projecting Sign



Example of a Projecting Sign



Example of a Projecting Sign



Examples of a Projecting Sign

A. Description

This sign is mounted perpendicular to a building's facade, by decorative brackets that may allow the sign to swing slightly; small in size. This type is pedestrian scaled and intended to be read along the sidewalk.

Synonyms: Blade Sign, Bracket Sign

General Note: Photos on this page are illustrative, not regulatory.

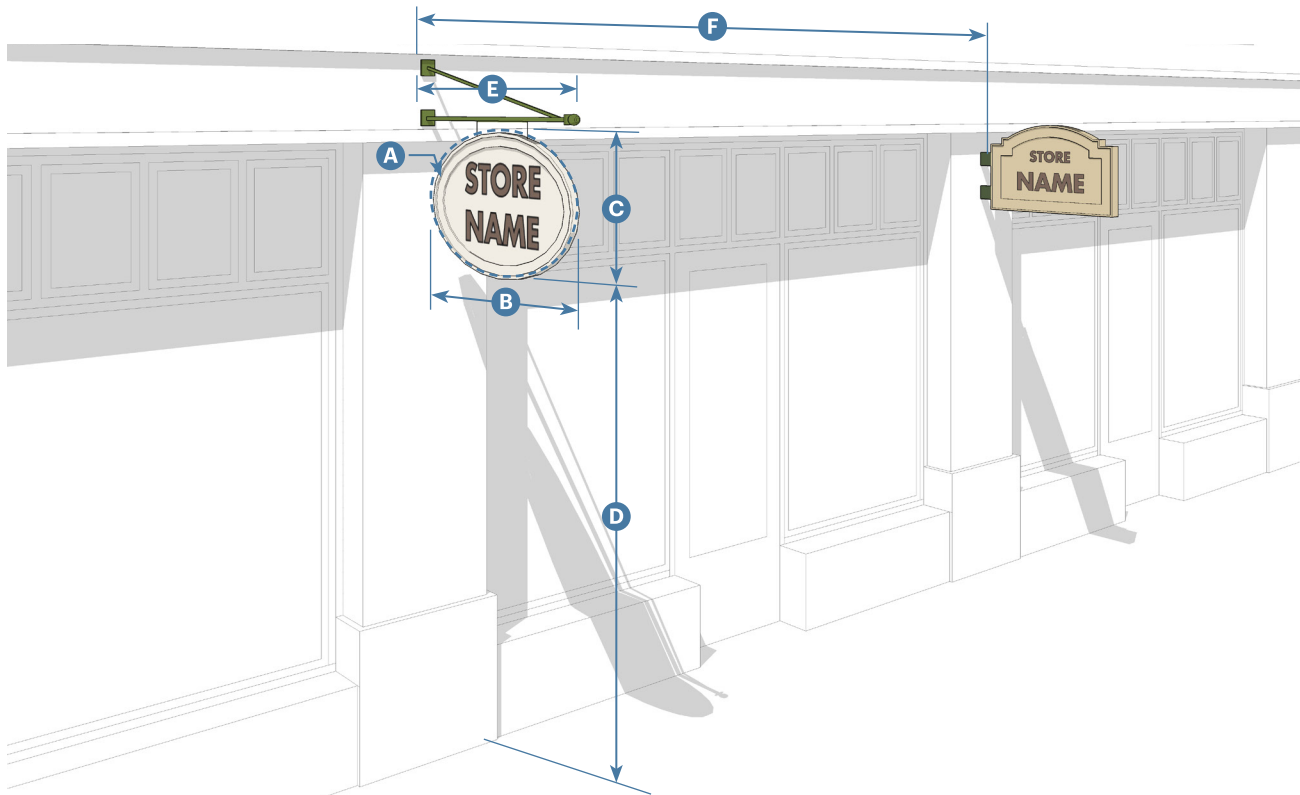

B. Sign Size		
Signable Area	6 sf per side, max.; 12 sf total, max.	A
Width	36" max.	B
Height	36" max.	C
Thickness	4" max.	

C. Location		
Clear Height	8' min.	D
Projection	4' max.	E
Distance between Signs	10' min.	F
D. Miscellaneous		
Neon is not allowed.		

8.060 Awning/Canopy Sign



Example of Awning Sign with signs on valance and canopy



Example of glass Awning/Canopy Sign



Examples of a Awning/Canopy Sign

1. Description

This sign is on the awning or canopy of a shopfront. This type is pedestrian scaled and intended to be read along the sidewalk or from the other side of the street.

General Note: Photos on this page are illustrative, not regulatory.

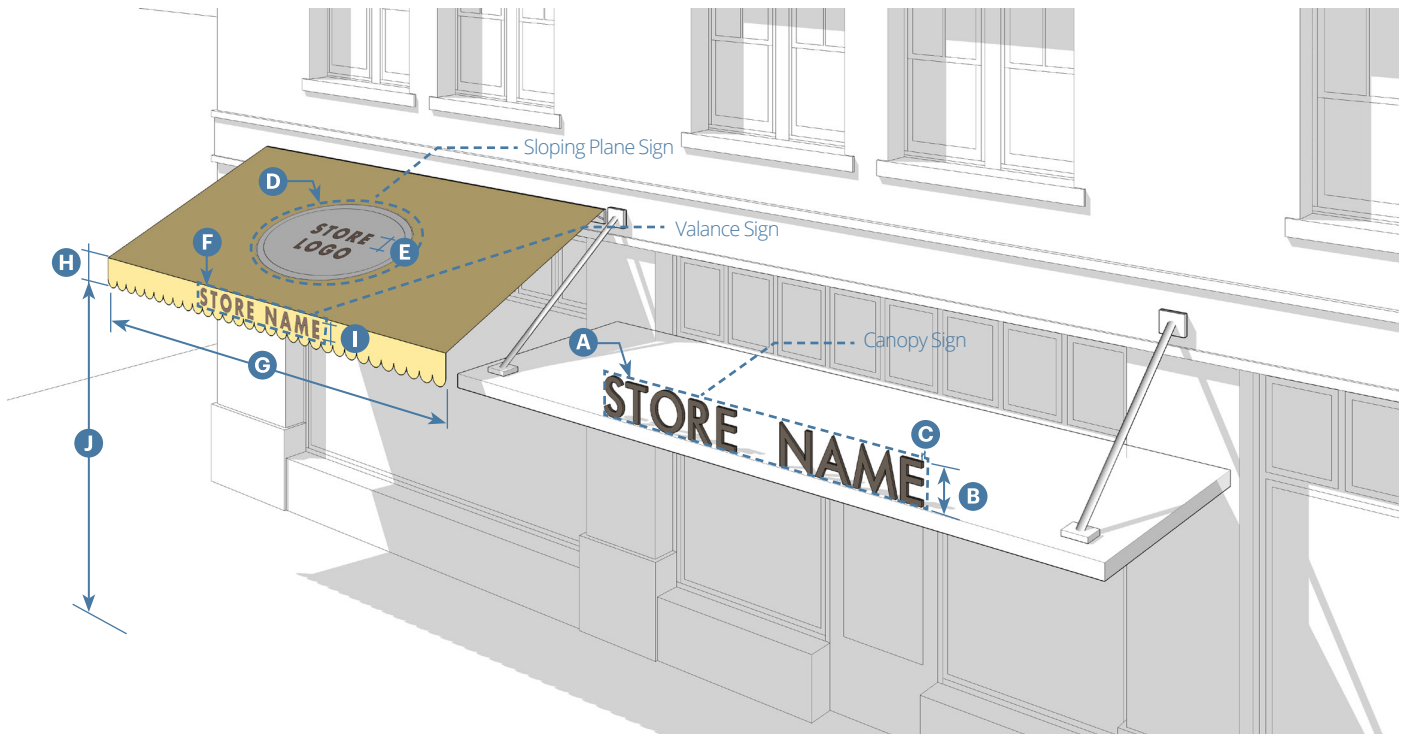

2. Sign Size

Canopy Sign

Signable Area	1 sf per linear foot of shopfront, max.	A
Lettering Height	16" max.	B
Lettering	6" max.	C
Thickness		

Awning/Sloping Plane Sign

Signable Area	25% coverage of sloping plane, max.	D
Lettering Height	18" max.	E

Valance Sign

Signable Area	75% coverage max. of width G and height H	F
Width	Shopfront width, max.	G
Height	8" min.; 12" max.	H
Lettering Height	8" max.	I

3. Location

Clear Height	8' min.	J
--------------	---------	----------

Signs per Awning	1 of each, max.
------------------	-----------------

Only the tenant's store name, logo, and/or address shall be applied to the Awning.

4. Miscellaneous

Vinyl or plastic, and closed-ended awnings are not allowed.

8.070 Wall Sign



Example of a Wall Sign integrated with the architecture



Example of Wall Sign



Example of Wall Sign

1. Description

This sign is flat against the facade, consisting of individual cut letters applied to a panel mounted directly to the building or painted directly on the wall surface. This type is pedestrian scaled when on the ground floor. This type is placed above shopfronts and runs horizontally along the 'expression line', entablature of traditional buildings, decorative cornice, or sign band at the top of the building.

General Note: Photos on this page are illustrative, not regulatory.



2. Sign Size

Signable Area	1 sf per linear foot of shopfront; width up to 80 sf max.	A
Signable Width	Shopfront width, max.	B
Signable Height	12" min.; 3' max.	C
Lettering/Image Width	75% of signable width, max.	D
Lettering/Image Height	75% of signable height or 18" max. (whichever is lesser)	E

3. Location

Projection	8" max.
------------	---------

Sign shall not project beyond the cornice.

4. Miscellaneous

- Internal illumination is not allowed.
- Neon is not allowed.

8.080 Painted Wall Sign



Example of a Painted Wall coordinated with the business sign



Example of Painted Wall Sign at a second story



Example of Painted Wall Sign coordinated with the business sign

1. Description

This sign is flat against a secondary facade, along a secondary front yard or an alley, or along the side of a vacant design site. These signs are painted directly on the building, pedestrian-scaled if on the ground floor and larger if on upper stories. These signs are intended to be visible from a greater distance and are accompanied by additional signage on the primary facade at the business entrance.

Synonym: Mural

General Note: Photos on this page are illustrative, not regulatory.

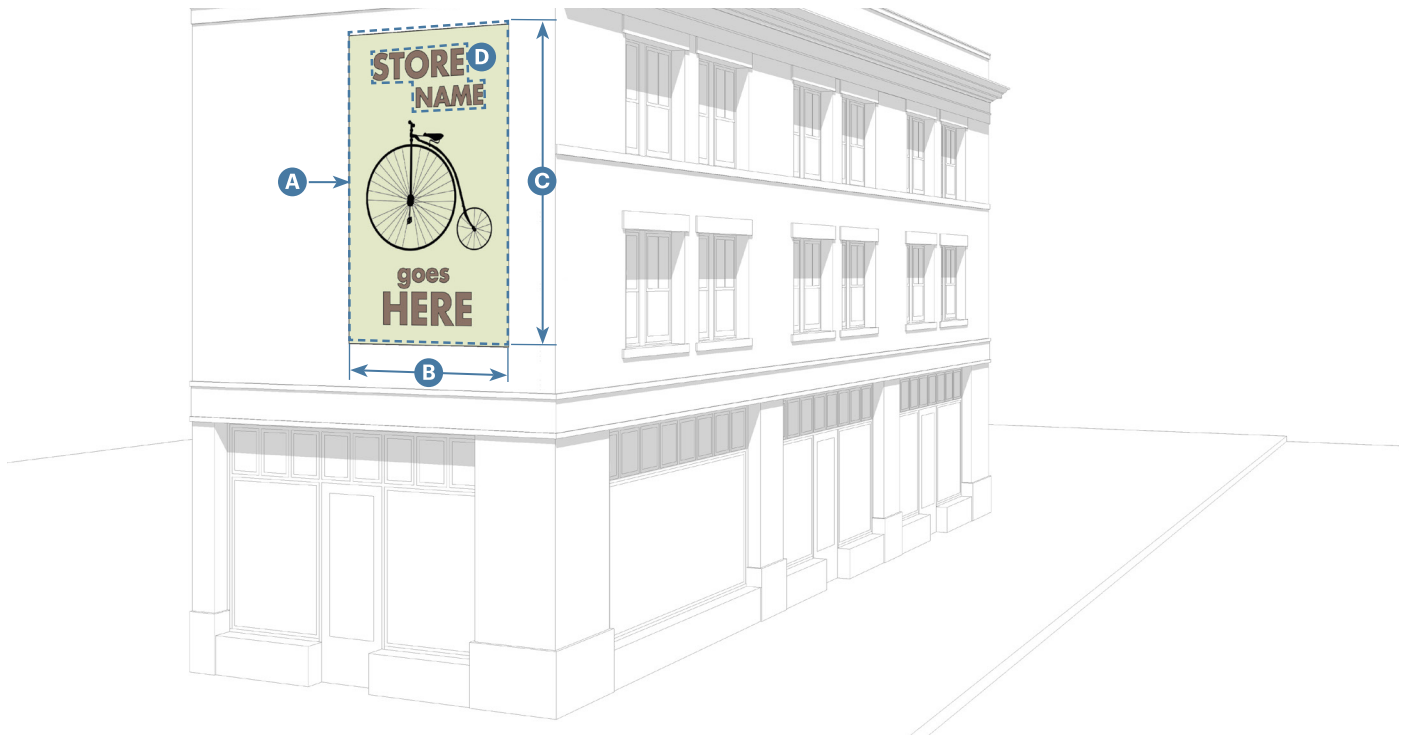

2. Sign Size

Signable Area		A
1-story	500 sf max.	
2-story	1,000 sf max.	
3-story	1,500 sf max.	
Width	Length of facade	B
Height		C
1-story	15' max.	
2-story	25' max.	
3-story	30' max.	
Text Area ¹	100 sf max. or 20% of signable area, whichever is less	D

¹ Includes business name, text relating directly to products or services sold on site, and logos

3. Location

Projection	None
------------	------

Painted Wall Signs are to be located on secondary facades.

8.090 Window Sign



Example of a Window Sign



1. Description

This sign consists of individual letters and designs applied directly on the inside of a window. This type is pedestrian scaled and intended to be read from the sidewalk.



Example of a Window Sign



Example of a Window Sign

General Note: Photos on this page are illustrative, not regulatory.

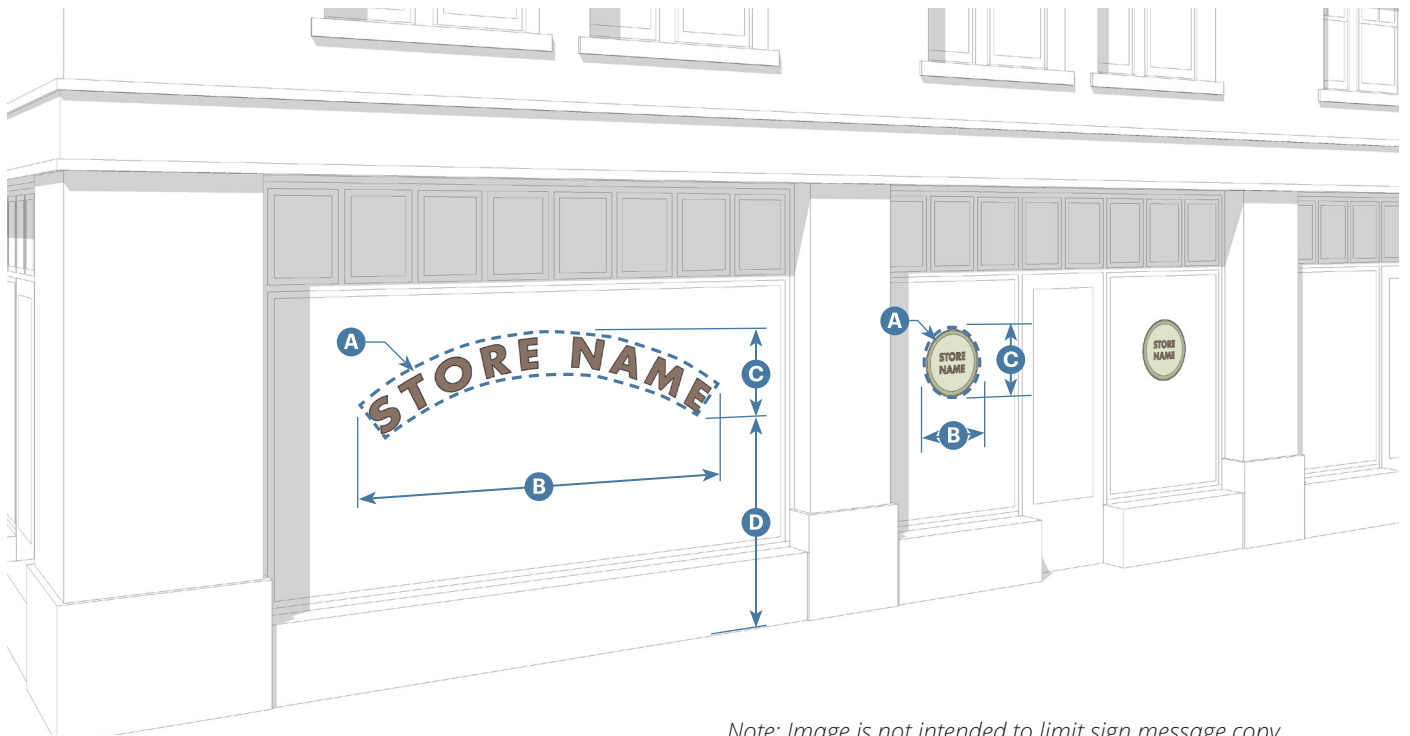

Note: Image is not intended to limit sign message copy.

2. Sign Size

Signable Area per Shopfront Window	25% max.	A
Width	75% max. of width of uninterrupted Shopfront glazing	B
Height	24" max.	C

3. Location

Height Above Ground	3' min.	D
---------------------	---------	----------

Window Signs shall be applied directly to the inside of the glass and be accessible for maintenance.

8.100 Sidewalk Sign



Example of a Sidewalk Sign



Example of a Sidewalk Sign



Example of a Sidewalk Sign

1. Description

This sign provides secondary signage and may be used to announce daily specials, sales, or point to shops off the sidewalk.

General Note: Photos on this page are illustrative, not regulatory.

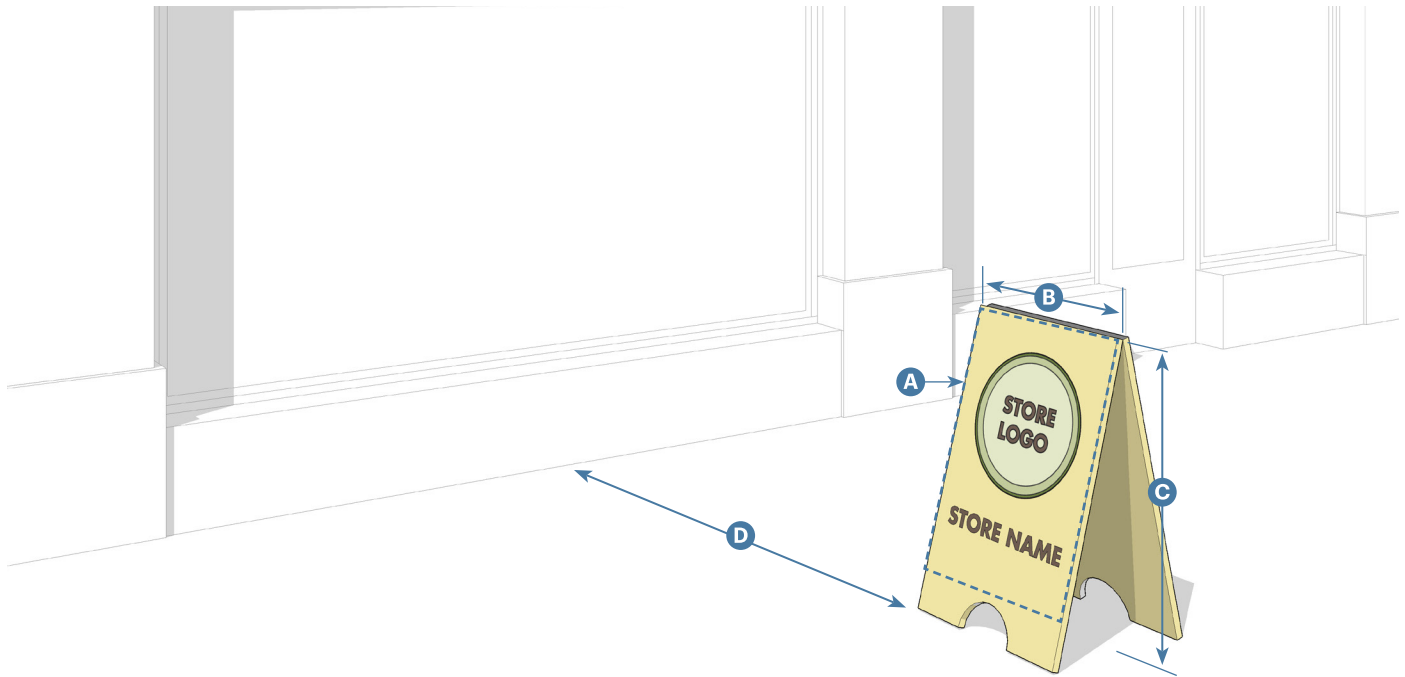

Note: Image is not intended to limit sign message copy.

2. Sign Size

Signable Area	6 sf per side, max.	A
Width	24" max.	B
Height	36" max.	C
Signs per Shopfront	1 max.	

3. Location

Sidewalk Signs shall not interfere with pedestrian travel **D** or encroach upon the required accessible path.

Sidewalk Signs shall only be displayed during business hours and removed when the business is closed.

4. Miscellaneous

Illuminated signs are not allowed.

8.110 Directory Sign



Example of a Directory Sign



Example of a Directory Sign



Example of a Directory Sign

A. Description

This sign provides a listing of establishments within a building or series of buildings. This type is pedestrian scaled and intended to be read from the sidewalk.

General Note: Photos on this page are illustrative, not regulatory.

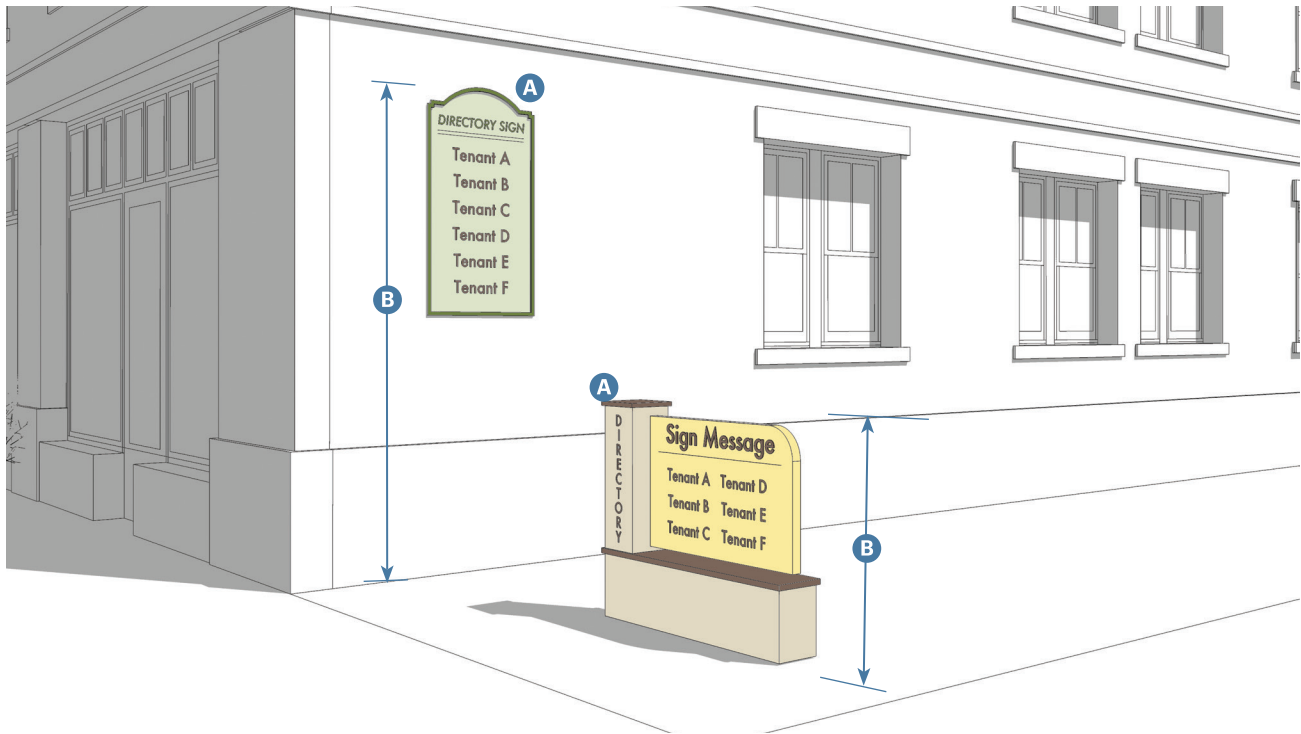

Note: Image is not intended to limit sign message copy.

B. Sign Size

Signable Area¹ 6 sf max. **A**

Both the Wall Mounted and the Freestanding Signs may be used on the same design site if separated by at least 35 feet.

¹ Does not apply to signs required by law

C. Location

Clear Height	8' min.	B
Wall Mounted	6'8" min.	
Freestanding	3' min.	

Directory Sign may include the names of the business and business address but shall not include any other words.

This page intentionally left blank

Chapter 9: Specific to Large Sites

Sections:

9.010	Purpose
9.020	Walkable Neighborhood Plan
9.030	General to Open Space
9.040	General to Thoroughfares

9.010 Purpose

This Chapter establishes standards to create walkable neighborhoods.

1. Development subject to this Chapter is required to create walkable neighborhoods with a mix of housing, civic, retail, and service uses within a compact, walkable, and transit-friendly environment.
2. Developments in compliance with this Chapter shall achieve the following goals:
 - A. Improve the built environment and human habitat;
 - B. Promote development patterns that support safe, effective, and multi-modal transportation options, including auto, pedestrian, bicycle, and transit;
 - C. Promote reductions in vehicle traffic, and support transit by providing for a mixture of land uses, highly interconnected block and thoroughfare network, and compact community form;
 - D. Generate or reinforce neighborhoods with a variety of housing types to serve the needs of a diverse population;
 - E. Promote the health benefits of walkable environments;
 - F. Generate pedestrian-oriented and scaled neighborhoods where the automobile is accommodated but does not dominate the streetscapes;
 - G. Reinforce the unique identity of Sebastopol and build upon the local context, climate, and history;
 - H. Realize development based on the patterns of existing walkable neighborhoods; and
 - I. Design that suits specific environmental, design site layout, and design constraints unique to the parcel(s).

9.020 Walkable Neighborhood Plan

1. **Applicability.** Projects which include a portion of a parcel, an entire parcel, or multiple parcels that meet one or more of the following criteria shall be subject to the requirements for a Walkable Neighborhood Plan (WNP) as described in this Chapter.
 - A. The project area is at least three acres;
 - B. Any linear dimension of the project areas is at least 400 feet;
 - C. The project area is or results in a through-lot or corner lot of at least one acre;
 - D. The project area includes design site(s) which do(es) not front onto an existing public street, within a parcel of five acres or more.
2. **Required Walkable Neighborhood Plan Content**
 - A. Each WNP shall include a set of plans that show the proposed physical character of the development, in plan view:
 - (1) Boundaries of the proposed development;
 - (2) Existing and proposed blocks within 1,500 linear feet of the development boundaries;
 - (3) New open space(s), in compliance with Section 9.030 (General to Open Space);
 - (4) New thoroughfare(s), in compliance with Section 9.040 (General to Thoroughfares);
 - (5) Proposed trees and landscaping along thoroughfares and in open space types.
 - (6) Mapping of proposed districts in compliance with Subsection 9.020.3.D;
 - (7) Identification of the proposed buildings or building types and frontage types on each block in compliance with the allowances of the district(s);
 - (a) As individual needs of a development may change over time, the building types specified in the WNP may be substituted with other building types allowed by the district in compliance with the district standards.
3. **Walkable Neighborhood Plan Standards**
 - A. **Thoroughfares and Blocks**
 - (1) New blocks within a development are created using new thoroughfares in compliance with Section 9.040 (General to Thoroughfares). Any of the thoroughfare types in Section 9.040 (General to Thoroughfares) and/or open space types in Section 9.030 (General to Open Space) may be used to define new blocks. Individual block lengths and the total block perimeter shall be in compliance with the standards in Table A (Block Size Standards).
 - (a) The arrangement of new thoroughfares shall provide for the alignment and continuation of existing or proposed streets into adjoining lands where the adjoining lands are undeveloped and intended for future development, or where the adjoining lands are undeveloped and include opportunities for such connections.
 - (b) Thoroughfares shall be extended to or along adjoining property boundaries to provide a roadway connection or street stub for development, in compliance with Table A (Block Size Standards), for each direction (north, south, east, and west) in which development abuts vacant land.

- (c) Right-of-way stubs shall be identified and include a notation that all stubs are to connect with future thoroughfares on adjoining property and be designed to transition in compliance with Section 9.040 (General to Thoroughfares).
- (d) New dead-end streets and cul-de-sacs are not allowed.
- (2) If a district requiring building types is mapped onto a block, the block shall be wide enough to result in two halves of developable design sites in compliance with the design site depth standards for the allowed building types in the district.
- (3) An attached half-block is allowed when adjoining an existing half-block.
- (4) Blocks may be uniquely shaped in compliance with the standards in Table A (Block Size Standards), and the allowed adjustments in Table 9.020.A (Adjustments to Standards).

Table 9.020.A: Block Size Standards			
District	Block Length	Block Perimeter	Depth of Attached Half-Block(s) ¹
T4MS.M	500' max.	1,800' max.	250' max.
All Other Districts	700' max.	1,800' max.	500' max.

¹ Distance from thoroughfare or public ROW to shared property line

Figure 9.020.1 Block Size

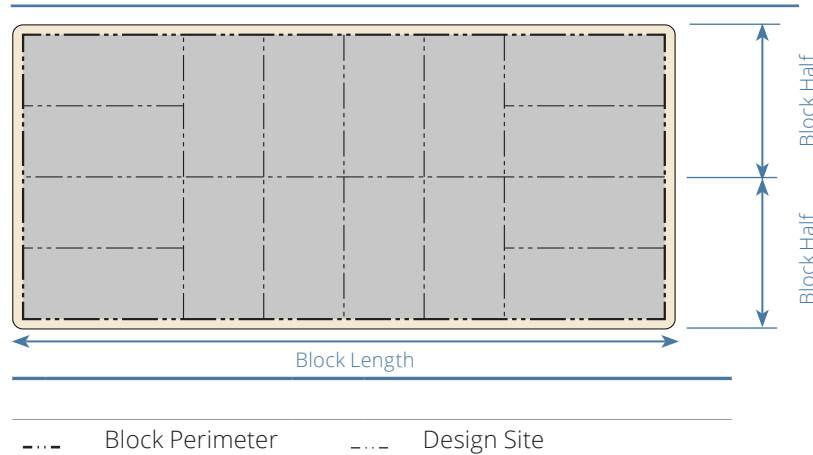

B. Open Space Required

- (1) A minimum of 10 percent of the net developable area shall be set aside as open space, after subtracting street and alley rights-of-way. Open space shall be designed in compliance with Section 9.030 (General to Open Space). One or more open spaces may be used to meet the required area.

C. Required Mix of Building Types and Private Frontage Types

- (1) Where a district requiring building types is mapped onto more than half of a new block (T3NE, T4N.S, T4MS.S, or T4MS.M), the WNP shall maintain a mix of at least two different building types within that block, using only the types allowed in the district. Half-blocks adjoining existing development are exempt.
- (2) Along each block face containing more than one building entrance, the WNP shall maintain a mix of at least two different private frontage types, using only the types allowed in the district(s).

D. Remapping of Districts for Large Sites

(1) **Allocation of Districts.**

- (a) The district(s) identified on the Form-Based District Map shall be replaced by one or more districts in compliance with this Chapter.
- (b) The proposed district(s) shall be selected only from the districts established in Chapter 3 (Districts) and shall be mapped on the proposed blocks and any existing blocks in the development according to the applicable General Plan Land Use Designation(s) in compliance with Table 9.020.B.

(2) **Organization of Districts.** Districts shall be organized and mapped in a manner that responds appropriately to the immediate design site context, in compliance with Table 9.020.C.

Table 9.020.B: Allowed Allocation of Districts by General Plan Land Use Designation

District	Land Use Designation				
	LDR	MDR	HDR	CO	CC
T3NE	●	●	●	●	●
T4N.S	● ¹	●	●	●	●
T4MS.S	---	---	---	●	●
T4MS.M	---	---	---	---	●

¹Open sub-district only

- Available district for the land use designation
- District not available for the land use designation

Table 9.020.C: Organization of Districts

Allowed Districts in Development	Within 65' of a single-family residential land use	Adjacent to commercial corridor	All other design sites
T3NE	●	---	●
T4N.S	●	● ¹	●
T4MS.S	---	●	●
T4MS.M	---	●	●

¹Open sub-district only

- District allowed in this location
- District not allowed in this location

E. Stormwater Management

(1) Integrated Design

- (a) Stormwater management is required through a system that is integral to the streetscapes and/or the open space(s) in the development in compliance with Chapter 15.78 [Storm Water Low Impact Development Technical Design Manual (LID Manual)].
- (b) The WNP shall identify the area(s) being proposed for managing stormwater. These areas are required to be a combination of the following:
 - i. Swale within a planted median;
 - ii. Swale within a continuous tree planter adjacent to the travel lane;
 - iii. Pond or other water body; and/or
 - iv. Areas within open space.
- (c) The area(s) used for stormwater management is to be designed for both seasonal temporary on-site retention of stormwater and as open space for the neighborhood(s) accessible to the public.
- (d) The stormwater management area(s) may connect with those of adjacent development(s).

(2) Stormwater Infrastructure within Thoroughfares

- (a) Storm drain pipes within thoroughfares listed in Section 9.040 (General to Thoroughfares) shall be RCP when 12" in diameter or larger. Storm drain pipes less than 12" in diameter shall be minimum SDR 35 pipe.
- (b) Storm manholes shall be constructed using City standard details for public infrastructure.

Figure 9.020.1 Stormwater Management Diagram

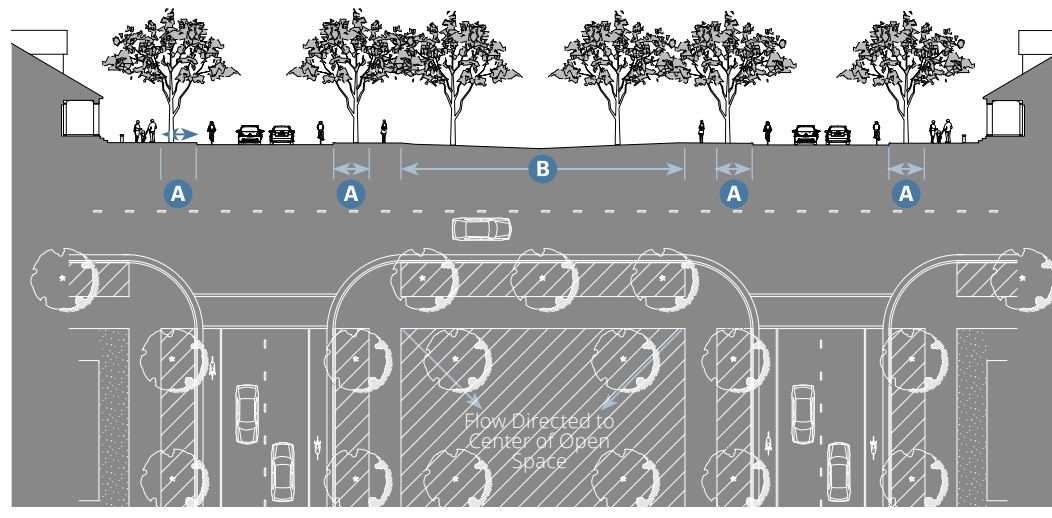



-  Potential Area for Stormwater Management
-  Planted Swale
-  Open Space Graded to also Accommodate Stormwater Retention

Figure 9.020.3: Walkable Neighborhood Plan Design Process Overview



9.030 General to Open Space

1. The WNP shall identify open space types in compliance with the following standards and the standards of Table 9.030.A (Open Space Types Overview). One or more open spaces shall be used to provide a minimum of ten percent of the net developable area of the development, after subtracting street and alley rights-of-way.
2. Open space is land that shall be privately owned and publicly accessible.
3. Each open space shall abut and be visible and accessible from a public ROW.
4. The Paseo thoroughfare type (9.040.5) may be counted as a open space type for the first 50 feet of its length, measured from the adjoining public ROW, provided that the following requirements are met:
 - A. No more than 25% of the paseo surface consists of asphalt or untextured poured concrete;
 - B. Seating is provided within or adjacent to the paseo at 100' max. intervals; and
 - C. Landscaping is provided within or adjacent to the paseo at 50' max. intervals.
5. **Building Frontage Along or Adjacent to a Open Space.** The façades on building design sites attached to or across a thoroughfare from a open space shall be designed as a "front" on to the open space, in compliance with Subsection 5 and Subsection 10 of the district.
6. Public access and visibility is required along public parks and natural open spaces, including creeks and stormwater management areas, and shall be fronted by:
 - A. Single-loaded frontage thoroughfares (those with development on one side and open space on the other);
 - B. Bike and pedestrian paths; or
 - C. Other methods of frontage that provide similar access and visibility to the open space, as district standards allow, such as through public easements.
7. **Open Space Types Overview.** This Subsection identifies the allowed open space types and standards for improvements to existing open spaces and for construction of new open spaces. For each open space type, Subsection 1 and Subsection 3 are regulatory, and Subsection 2 and Subsection 4 are non-regulatory. Allowed open space types are identified in Table 9.030.A (Open Space Types Overview).

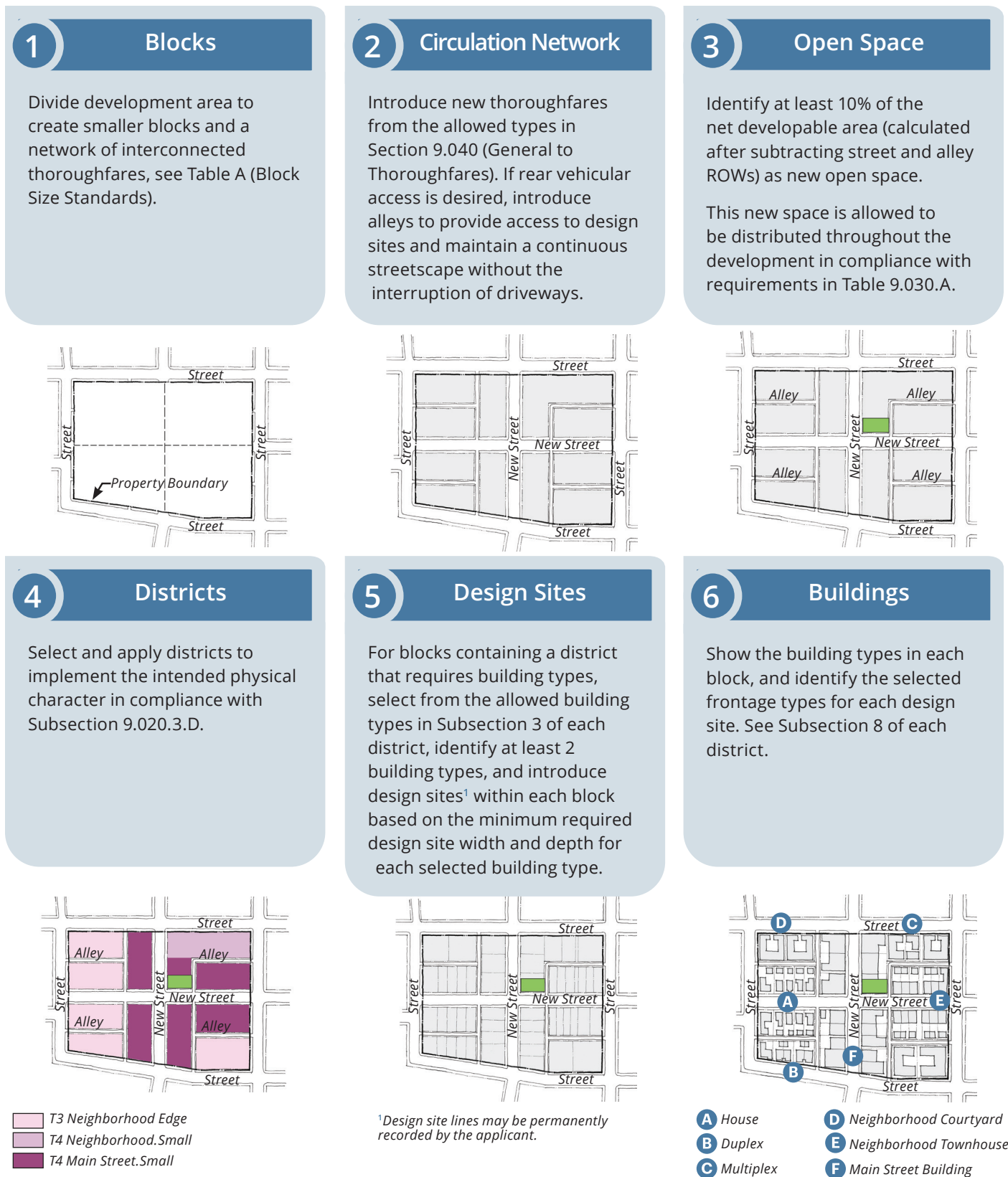
Table 9.030.A: Open Space Types Overview					
	Specific Standards	Districts			
		T3	T4		
		T3NE	T4N.S	T4MS.S	T4MS.M
Green	9.030.7	P	P	---	---
Plaza	9.030.8	---	---	P	P
Playground	9.030.9	P	P	P	P
Community Garden	9.030.10	P	P	P	P
Passage	9.030.11	P	P	P	P
Key	P = Allowed	--- = Not Allowed			

8. Green



1. Description

A large space available for unstructured and limited amounts of structured recreation.

2. General Character

Formal or informal with integral stormwater management capacity

Primarily planted areas with paths to and between recreation areas and civic buildings

Spatially defined by tree-lined thoroughfares and adjacent buildings

3. Size and Location

Size 5,000 sf min. with dimension of at least 50'

Thoroughfare required on at least one side of the Green.

Façades on design sites attached to or across a thoroughfare from the Green shall "front" onto the Green on at least two sides.

4. Typical Uses

Uses as allowed by the District

9. Plaza



1. Description

A community-wide focal point primarily for civic purposes and commercial activities.

2. General Character

Formal, urban

Hardscaped and planted areas in formal patterns

Spatially defined by buildings and tree-lined thoroughfares

3. Size and Location

Size 50' x 50' min.

Thoroughfare required on at least one side of the Plaza.

Façades on design sites attached to or across a thoroughfare shall "front" on to the Plaza on all sides.

4. Typical Uses

Uses as allowed by the District

10. Playground



1. Description

A small-scale space designed and equipped for the recreation of children. These spaces serve as quiet, places protected from the street and in locations where children do not have to cross any major streets. An open shelter, play structure(s), or interactive art and fountain(s) may be included. Playgrounds may be included within all other open space types except Community Garden.

2. General Character

Play structure(s), interactive art, and/or fountain(s)

Shade and seating provided

May be fenced

Spatially defined by trees

3. Size and Location

Size 40' x 60' min.

4. Typical Uses

Uses as allowed by the District

11. Community Garden



1. Description

A small-scale space designed as a grouping of garden plots available for small-scale cultivation. Community gardens may be fenced and may include a small accessory structure for storage. Community Gardens may be included within all other open space types except Playgrounds.

2. General Character

Informal or Formal, urban

Combination of planted areas and hardscape

Spatially defined by building frontages and adjacent street trees

Walkways along edges or across space

3. Size and Location

Size 2,500 sq ft min. with dimension of at least 50'

4. Typical Uses

Uses as allowed by the District

12. Passage



1. Description

A pedestrian pathway that extends from a public sidewalk or open space. The pathway is lined by non-residential shopfronts and/or residential ground floors and pedestrian entries as required by the district.

2. General Character

- Formal, urban
- No accessory structure(s)
- Primarily hardscape with landscape accents
- Spatially defined by building frontages
- Trees and shrubs in containers and/or planters

3. Size and Location

- Width (clear) 20' min. between or through buildings
- Length 150' max.; unlimited if extending from one public sidewalk or open space to another
- Ground floor façades shall be in compliance with façade zone in Subsection 5 and frontages allowed in Subsection 8 of the district.
- Dooryards, porches, patios, and sidewalk dining shall not encroach into the minimum required width.

4. Typical Uses

- Civic and commercial activity as allowed by the district
- Ground floor residential as allowed by the district

9.040 General to Thoroughfares

1. **Connectivity.** Thoroughfare(s) and/or open space(s) are to be applied to create walkable neighborhoods with additional routes for vehicular, bicycle, and pedestrian circulation.
 - A. Thoroughfares that pass from one district to another are required to transition in their streetscape along the thoroughfare's edges. For example, while a thoroughfare within a more intense district (e.g., T4MS.M) with retail shops may have wide sidewalks with trees in grates, it shall be designed to transition to a narrower sidewalk with a planting strip within a less intense district (e.g., T4N.S) with lower intensity residential building types.
 - B. The proposed network shall connect to the existing network through pedestrian or multimodal connections. New thoroughfares shall provide connecting pedestrian and bicycle routes to all adjacent public, non-limited-access ROWs and dead-end streets.
 - C. The network can be privately owned but shall be accessible by the general public.
2. **Pedestrian Network.** Thoroughfares are intended to generate one contiguous pedestrian network throughout the development site and adjacent public rights of way.
 - A. Design sites that do not front onto this pedestrian network are not permitted.
 - B. The pedestrian network may be composed of sidewalks (6' min. width), thoroughfares as provided in this Section, and/or open spaces as provided in Section 9.030 (General to Open Space).
 - C. The pedestrian network shall incorporate ADA accessible crosswalk(s) where pedestrian paths intersect vehicular travel lanes.
3. **Alleys**
 - A. Vehicular access to parking may be accommodated through public or private rear alleys. Alleys may also serve as routes for waste collection and fire department apparatus access roads, in compliance with the applicable standards.
 - B. Design sites adjoining an alley at least 20 feet wide along the rear design site line may be reduced in depth by a distance equal to the width of the alley. Rear setbacks may be reduced as allowed by Table 9.020.A (Adjustment to Standards). Front setbacks shall not be reduced.
4. **Pavement Standards**
 - A. Pavement design for travel lanes and emergency vehicle access lanes within thoroughfare types shall be prepared by a **geotechnical** civil engineer, with a minimum pavement thickness of 4".
 - B. Curb, gutter, and sidewalk shall use City approved plain cement concrete mix or better.

Missed Edit:

In subsection 9.040.4.A, replaced "geotechnical" with "civil"

Table 9.040.1: Thoroughfare Overview

This Table provides an overview of the allowed thoroughfare types.

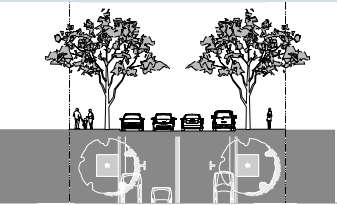
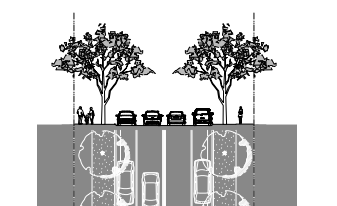
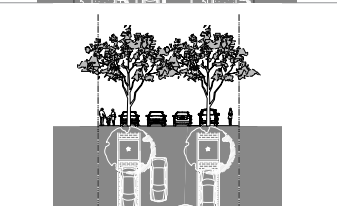
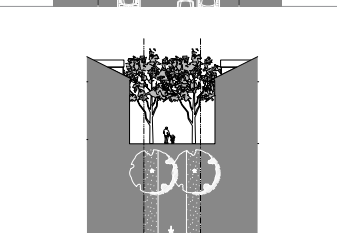
Thoroughfare Type		ROW
	<p>Main Street, Parallel Parking. The design consists of two travel lanes, on-street parallel parking, and 10-foot sidewalks with tree wells.</p> <p>See 9.040.2</p>	60'
	<p>Neighborhood Street, Parallel Parking and Planter Strip. The design consists of two travel lanes, on-street parallel parking, and 6-foot sidewalks each buffered by a continuous planter strip.</p> <p>See 9.040.3</p>	60'
	<p>Neighborhood Street, Parallel Parking with Tree Wells. The design consists of two travel lanes, on-street parallel parking with tree wells, and 6-foot sidewalks.</p> <p>See 9.040.4</p>	56'
	<p>Paseo. The type is used on longer blocks to result in two block-halves in compliance with the block standards. The design consists of one shared pedestrian path with 10% minimum landscaping in containers and/or planters.</p> <p>See 9.040.5</p>	26'-30'

2. Main Street, Parallel Parking

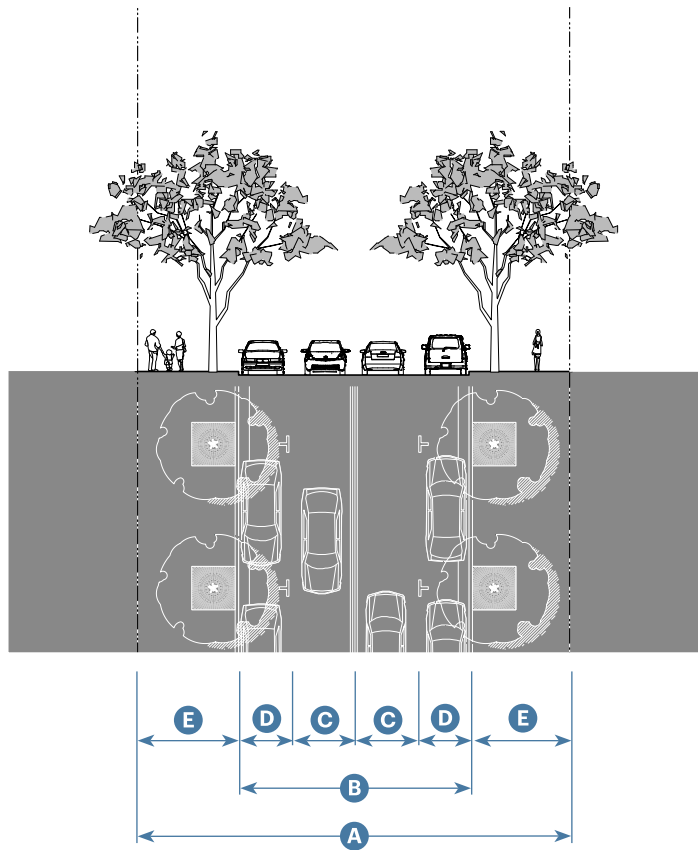

A. Application

Local	
Movement Type	Slow
Design Speed	20-25 mph

B. Overall Widths

Right-of-Way (ROW) Width	60'	A
Curb-to-Curb Width	40'	B

C. Lane Assembly

Traffic Lanes	2 @ 8'	C
Bicycle Lanes	2 @ 5'	
Parking Lanes	2 @ 7', marked	D
Medians	None	

D. Public Frontage Assembly

Standards for T4MS.M District

Drainage Collection Type	Curb and gutter
Planter Type	4' x 4' tree wells
Landscape Type	Trees at 30' o.c. avg.
Lighting Type	Post or column
Walkway Type	10' sidewalk E
Curb Type	Raised
Curb Radius	10' - 15'

Standards for All Other Districts

Min 5' sidewalk; landscaping and drainage as required by City standards in (City to provide reference).

3. Neighborhood Street, Parallel Parking and Planter Strip

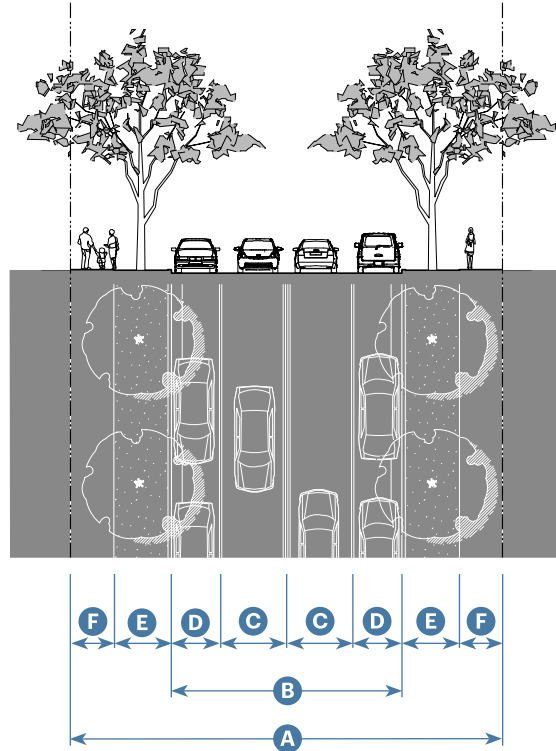

A. Application

Local	
Movement Type	Slow
Design Speed	20-25 mph

B. Overall Widths

Right-of-Way (ROW) Width	60'	A
Curb-to-Curb Width	40'	B

C. Lane Assembly

Traffic Lanes	2 @ 8'	C
Bicycle Lanes	2 @ 5'	
Parking Lanes	2 @ 7', marked	D
Medians	None	

D. Public Frontage Assembly

Standards for T4MS.M District

Drainage Collection Type	Curb and gutter
Planter Type	4' continuous planter E
Landscape Type	Trees at 30' o.c. avg.
Lighting Type	Pipe, post, or column
Walkway Type	6' sidewalk F
Curb Type	Raised
Curb Radius	10' - 15'

Standards for All Other Districts

Min 5' sidewalk; landscaping and drainage as required by City standards in (City to provide reference).

4. Neighborhood Street, Parallel Parking with Tree Wells

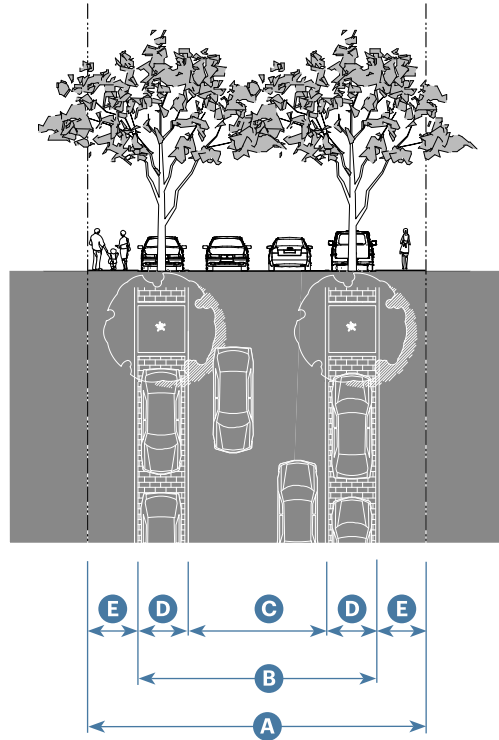

A. Application

Local	
Movement Type	Slow
Design Speed	20-25 mph

B. Overall Widths

Right-of-Way (ROW) Width	56'	A
Curb-to-Curb Width	40'	B

C. Lane Assembly

Traffic Lanes	2 @ 8'	C
Bicycle Lanes	2 @ 5'	
Parking Lanes	2 @ 7', marked	D
Medians	None	

D. Public Frontage Assembly

Standards for T4MS.M District

Drainage Collection Type	Valley gutter or sheet flow
Planter Type	4'x6' planter at 50' o.c.
Landscape Type	Trees at 50' o.c. avg.
Lighting Type	Post or column
Walkway Type	Min. 6' sidewalk E
Curb Type	Rolled or flush
Curb Radius	10' - 15'

Standards for All Other Districts

Min 5' sidewalk; landscaping and drainage as required by City standards in (City to provide reference).

5. Paseo

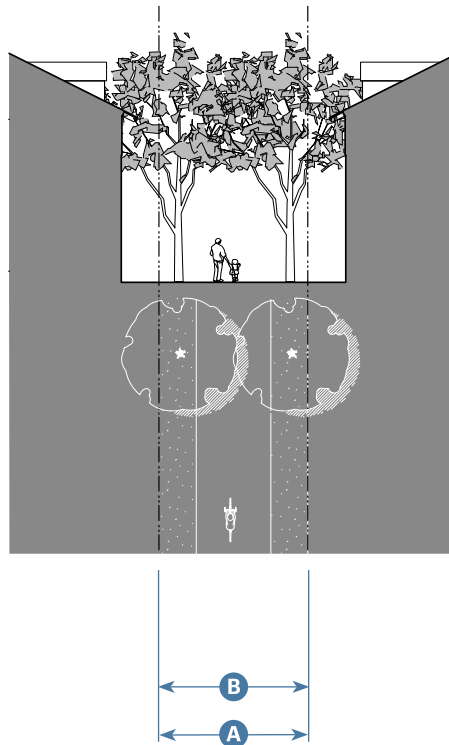

A. Application

Local	
Movement Type	Pedestrian, Bicycle, Emergency Vehicle Access ¹

B. Overall Widths

Right-of-Way (ROW) Width	26' min.; 30' max.	A
Pavement Width	Variable ¹ ; flush	B

C. Lane Assembly

Traffic Lanes	None
Pedestrian/Bike Path	10' min., unmarked
Emergency Vehicle Access Route ¹	26' min.
Parking Lanes	None
Medians	None

¹ Where the paseo is required or intended to allow emergency vehicle access, paving assembly and clear width shall meet the applicable standards.

D. Public Frontage Assembly

Standards for T4MS.M District

Design sites fronting onto a Paseo shall apply the secondary front yard building setback standards of the applicable district in place of the front building setback standards.

Drainage Collection Type	None
Planter Type	Raised
Landscape Type	Potted Plants, Planters
Lighting Type	Pipe, post, or column
Walkway Type	Multipurpose path
Curb Type	Flush

Standards for All Other Districts

Min 5' sidewalk; landscaping and drainage as required by City standards in (City to provide reference).

Chapter 10: Administration

Sections:

10.010	Purpose
10.020	Procedures
10.030	Adjustments to Standards

10.010 Purpose

This Chapter is intended to establish procedures for applications eligible for streamlined review consistent with State law (i.e., Senate Bill 35) and for reviewing applications under the Housing Accountability Act. The City of Sebastopol is responding to State mandates and including application procedures in the ODS that are compliant with State law but reflect the unique conditions and procedures within the City. The intent of Senate Bill 35 and the Housing Accountability Act is to facilitate and expedite the construction of housing through the application of objective standards and, with Senate Bill 35, ministerial and streamlined approval procedures. These procedures shall be used in conjunction with the objective standards contained in this ODS as applicable.

10.020 Procedures

1. **Procedures for Applications Filed Under Senate Bill 35**
 - A. **Applicability**
 - (1) This Section applies to housing development projects applying for approval under Government Code §65913.4 and replaces the City's procedures for reviewing discretionary applications.
 - (2) This Section shall remain in effect for the same period as Senate Bill 35 provisions contained in Government Code §65913.4. Unless Senate Bill 35 provisions are extended by the State Legislature, this Section shall remain in effect only until January 1, 2026, and as of that date is repealed.
 - (3) The California Environmental Quality Act (CEQA) does not apply to projects eligible under Senate Bill 35.
 - (4) The Department of Housing and Community Development is charged with developing guidelines for implementing Senate Bill 35. These procedures may change if required by changes in those guidelines or in Government Code §65913.4.

- B. **Definitions.** Terms defined in Government Code §65913.4 shall apply to this Section and shall control in the event of a conflict between definitions in this ODS and definitions in Government Code §65913.4.
- C. **Application Filing**
- (1) **Preliminary Application Filing.** An applicant shall file a notice of intent to submit a Senate Bill 35 application in the form of a preliminary application consistent with Government Code §65941.1.
- (a) **Form.** A preliminary application shall be filed on a form provided by the City with the required fee. If the City has not prepared a form, a preliminary application shall be filed on the standardized form adopted by the California Department of Housing and Community Development.
- (b) **Timeline.** Within 180 calendar days after submitting a preliminary application, an applicant shall submit a full Senate Bill 35 application, provided scoping consultation has concluded consistent with Subsection (c), below.
- (c) **Scoping Consultation**
- i. Upon receipt of the preliminary application, the City shall contact the Native American Heritage Commission for assistance in identifying any California Native American tribe that should be noticed. The City shall provide a formal notice of the applicant's intent to submit a full application to each required California Native American tribe within 30 days of preliminary application submittal. The formal notice shall be consistent with Government Code §65913.4(b).
- ii. If, within 30 days of receipt of the formal notice, any California Native American tribe that was formally noticed accepts the invitation to engage in scoping consultation, the City shall commence scoping consultation within 30 days of receiving that response.
- iii. Scoping consultation shall be conducted consistent with Government Code §65913.4(b). If, after scoping consultation is concluded, a development is not eligible for Senate Bill 35 streamlining, the City shall provide written documentation as required by Government Code §65913.4(b) to the applicant and any California Native American tribe that is a party to that scoping consultation.
- iv. If consultation results in the project being eligible, but requires an AB 168 Agreement, the California Native American Tribe, the Applicant, and the City shall enter into a binding AB168 agreement. Any conditions of approval of that agreement shall become part of any SB35 project application and subsequent approval/conditions of approval.
- (2) **Full Application.** If the development remains eligible to apply under Senate Bill 35 after scoping consultation consistent with Government Code §65913.4(b) has concluded, an applicant may file a full Senate Bill 35 application on a form provided by the City with the required fee. A full SB35 application shall include information for all Planning entitlements necessary to determine consistency with the City's Objective Design Standards. The Planning Director may waive non-critical subsequent permits (signs, fences, etc.).

- D. **Completeness Review.** The City shall review an application for compliance consistent with Subsection 1.E; there shall be no separate or additional timeframe for completeness review. Only the items necessary to determine compliance with the provisions contained in Government Code §65913.4(a) shall be required.
- E. **Compliance Review**
- (1) **Scope of Review.** The Review Authority's scope of review is limited to all of the provisions contained in Government Code §65913.4(a) and the objective standards in effect at the time of preliminary application submittal.
- (2) **Review Timeframes and Review Authority**
- (a) **Consistency Review.** The Planning Director shall determine if the application complies with all of the provisions contained in Government Code §65913.4(a) and applicable objective standards within the following timeframes:
- i. Within 60 calendar days of application submittal for applications that include 150 or fewer housing units.
 - ii. Within 90 calendar days of application submittal for applications that include 151 or more housing units.
- (b) **Public Oversight.** Public oversight includes the right to appeal both the consistency review and the compliance determination. Any appeals, from either the applicant or the public, shall be submitted in accordance with Chapter 17.455 (Appeal Procedure). Any appeals shall be heard by the City Council. Any public oversight (i.e., Public Body review) to determine if the application complies with all of the provisions contained in Government Code §65913.4(a) and applicable objective standards shall occur within the following timeframes identified in this Section.

(3) **Compliance Determination**

- (a) **Compliant Application.** If the application complies with all of the provisions contained in Government Code §65913.4(a) and all applicable objective standards, the City shall complete any public oversight and any subdivision approval within the timeframes listed in Subsection 1.E. Only objective design and subdivision standards may be applied. See Subsection 1.F.
- (b) **Non-Compliant Application.** If the application does not comply with all of the provisions contained in Government Code §65913.4(a) and all applicable objective standards, the Review Authority shall make the following determination:
- i. If the application does not comply with all of the provisions contained in Government Code §65913.4(a) and all applicable objective standards, the Review Authority shall provide the applicant with written documentation of which standards the development conflicts with and an explanation of the reasons the development conflicts with each standard.
 - ii. **New Application.** If the project was found to be non-compliant, the applicant may submit a new application for Senate Bill 35 streamlining, and the City shall review it for compliance with all of the provisions contained in Government Code §65913.4(a) and all applicable objective standards subject to the same timelines in Subsection (2) above. If the non-compliant items are minor in nature, and the Planning Director determines that there is adequate time within the State-mandated timelines for City review and Public Oversight (appeals), the Planning Director may allow the applicant to submit under the original SB35 timeline. Additionally, in any new submittals, the Planning Director may waive the submittal of items that were consistent with the City's objective standards from prior submittals.
 - iii. **Project Ineligible.** If the project is ineligible for Senate Bill 35 streamlined processing, the applicant may elect to submit an application for the applicable discretionary approval.

F. **Decision on Project**

- (1) **Project Approval and Findings.** The Review Authority shall approve the application if the Review Authority finds that the proposed development is compliant with all of the provisions contained in Government Code §65913.4(a) and all applicable objective standards, including objective subdivision standards.
- (2) **Conditions of Approval.** The Review Authority may impose conditions of approval provided those conditions of approval are objective and broadly applicable to development within the City.
- (3) **Appeals.** See Subsection 10.020.1.E.(2).(b)

G. Post-decision Procedures

- (1) **Subsequent Permits.** Any necessary subsequent permits shall be issued on a ministerial basis subject to applicable objective standards. If a public improvement is necessary to implement a development subject to this Section, and that public improvement is located on land owned by the City, the Review Authority shall process any approvals needed as required by Government Code §65913.4(h)(3).
- (2) **Post-Approval Modifications**
 - (a) **Post-Approval Modification Request.** An applicant or the City may request a modification to an approved development if that request is made prior to the issuance of the final building permit.
 - (b) **Applicability of Objective Standards to Modifications.** The Review Authority shall only apply objective standards in effect when the original application was submitted, except that objective standards adopted after the date of original submittal may be applied in any of the following instances:
 - i. The total number of residential units or total square footage of construction changes by 15 percent or more; or
 - ii. The total number of residential units or total square footage of construction changes by five percent or more, and it is necessary to subject the development to an objective standard beyond those in effect when the application was submitted in order to mitigate or avoid a specific adverse impact upon public health or safety, for which there is no feasible alternative method to satisfactorily mitigate or avoid.
 - iii. Objective building standards contained in Title 24 may be applied to all modifications.
 - (c) **Post-Approval Modification Review Timeframe and Decision.** The Review Authority shall determine if the modification is consistent with objective planning standards and issue a decision on the applicant's modification request within 60 days after submittal.
- (3) **Expiration.** An application approved consistent with this Section shall remain valid for three years; however, an application approval shall not expire if the development includes public investment in housing affordability, beyond tax credits, where 50 percent of the units are affordable to households making at or below 80 percent of the area median income consistent with Government Code §65913.4(f).
- (4) **Extension.** At the discretion of the Review Authority, a one-year extension may be granted consistent with Government Code §65913.4(f)(3).

2. **Procedures for applications filed consistent with the** Housing Accountability Act
 - A. **Applicability**
 - (1) This Section applies to housing development projects as defined by Government Code §65589.5(h)(2).
 - (2) This Section shall remain in effect for the same period as provisions contained in the Government Code §65589.5 (Housing Accountability Act). Any provisions that are not extended by the State Legislature shall be repealed as of the date those provisions in the Housing Accountability Act are deemed null and void.
 - B. **Definitions.** Terms defined in Government Code §65589.5 shall apply to this Section and shall control in the event of a conflict between definitions in this ODS and definitions in Government Code §65589.5.
 - C. **Application Filing**
 - (1) **Preliminary Application Filing (Optional).** An applicant may file a preliminary application consistent with Government Code §65941.1.
 - (a) A preliminary application shall be filed on a form provided by the City with the required fee. If the City has not prepared a form, a preliminary application shall be filed on the standardized form adopted by the California Department of Housing and Community Development.
 - (b) Within 180 calendar days after submitting a preliminary application, an applicant shall submit a full application for the housing development.
 - (2) **Full Application.** An applicant may file a full application for a housing development without filing a preliminary application. The full application shall be filed on a form provided by the City with the required fee.
 - D. **Conflicting Procedures.** This Section provides additional procedures that shall be followed for applicable projects. If conflicts occur between the City's procedures and the procedures of this Section, this Section shall control.

E. Completeness Review

- (1) **Preliminary Application.** If a preliminary application is filed, the preliminary application shall be deemed complete when the preliminary application containing all of the information listed in the preliminary application form is submitted. If all listed information is not provided, the City shall request the missing information from the applicant.
- (2) **Full Application**
 - (a) Once a full application is submitted, the City shall inform the applicant in writing within 30 calendar days of submittal or new submittal that the application is complete or incomplete and the additional information required consistent with Government Code §65943. Only information requested in the City's application forms can be requested. If the City does not provide written notification within this timeframe, the application shall be deemed complete. The City shall review each new submittal within the 30-day period and cannot request information that was not listed in the first incompleteness letter.
 - (b) If an applicant receives written notification that the application is incomplete, and a preliminary application was submitted for the housing development, the applicant shall submit the information needed to complete the application within 90 calendar days of receiving the written notification of incompleteness. If the applicant does not submit this information within this timeframe, the preliminary application shall expire and have no further force or effect.
 - (c) If a second determination of incompleteness is provided, the applicant shall be able to appeal the decision to the Governing Body. The City shall make a decision on the appeal no later than 60 calendar days after receipt of the applicant's written appeal. The initial appeal may be to the Planning Commission, but in that case the Governing Body shall still make a decision within 60 days. If the decision on the appeal is not made within this timeframe, the application shall be deemed complete.

F. Compliance Review

(1) Scope of Review

- (a) **Housing Development with a Preliminary Application Submittal.** A housing development for which a preliminary application was submitted shall only be subject to the ordinances, policies, and standards adopted and in effect when the preliminary application is submitted, except in the following circumstances:
- i. A fee, charge, or other monetary exaction increase resulting from an automatic annual adjustment based on an independently published cost index that is referenced in the ordinance or resolution establishing the fee or monetary exaction.
 - ii. A preponderance of the evidence in the record establishes that subjecting the housing development to an ordinance, policy, or standard beyond those in effect when the preliminary application was submitted is necessary to mitigate or avoid a specific, adverse impact upon the public health or safety, and there is no feasible alternative method to satisfactorily mitigate or avoid the adverse impact.
 - iii. Subjecting the housing development to an ordinance, policy, standard, or any other measure, beyond those in effect when the preliminary application was submitted is necessary to avoid or substantially lessen an impact consistent with CEQA.
 - iv. The housing development has not commenced construction within 2.5 years following the date of the housing development's final approval (as defined in Government Code §65589.5(o)(1)(D)).
 - v. The number of residential units or square footage of construction proposed changes by 20 percent or more, exclusive of any increase resulting from a density bonus, incentive, concession, waiver, or similar provision.
- (b) **Housing Development without a Preliminary Application Submittal.** A housing development shall be subject to objective standards in effect when the application was deemed complete.

(2) **Review Timeframes**

- (a) Applications for housing development containing 150 or fewer units shall be reviewed for compliance with applicable objective standards within 30 calendar days of being deemed complete.
- (b) Applications for housing development containing more than 150 units shall be reviewed for compliance with applicable objective standards within 60 calendar days of being deemed complete.

(3) **Review Authority.** The Review Authority shall be the Review Authority consistent with the City's procedures for the full application; however, if the Director is not the Review Authority, the Director may serve as the Review Authority, if necessary, to comply with Review Timelines described in Subsection 2.F.

(4) **Compliance Determination**

- (a) The Review Authority shall identify the specific standard(s) that the project does not comply with and provide an explanation of the reason(s) why the housing development is considered to be inconsistent or non-compliant with identified provisions and shall provide the written determination to the applicant.
- (b) A housing development is considered in compliance with this ODS, and shall not require a Zoning Map Amendment, if the housing development complies with objective General Plan standards but the zoning for the housing development site is inconsistent with the General Plan.

(5) **Limited Hearings/Meetings.** If a housing development complies with applicable objective standards and does not require any zoning amendments (rezoning), the City shall not conduct more than five public hearings (including continuances), workshops, or similar meetings after the full application is complete in connection with the approval of the housing development consistent with Government Code §65905.5. Meetings required by CEQA are exempt from the limit.

G. Findings and Decision

(1) Findings

- (a) If the proposed housing development complies with applicable objective General Plan, zoning, and subdivision standards and criteria, including design review standards, the Review Authority may only deny the housing development or conditionally approve the housing development at a lower density if the Review Authority makes written findings supported by a preponderance of the evidence in the record that:
 - i. The housing development would have a specific, adverse impact upon the public health or safety unless the housing development is denied or conditionally approved at a lower density. A "specific, adverse impact" means a "significant, quantifiable, direct, and unavoidable impact, based on identified written public health or safety standards, policies, or conditions as they existed on the date that the project was deemed complete"; and
 - ii. There is no feasible method to satisfactorily mitigate or avoid the adverse impact other than the denial of the housing development or conditional approval of the housing development at a lower density.
- (b) If the housing development includes 20 percent of units affordable to very low or low-income households, 100 percent of units affordable or moderate or middle income households, or an emergency shelter, the Review Authority shall approve the housing development unless the Review Authority makes written findings supported by a preponderance of the evidence in the record, as to at least one of the findings in Government Code §65589.5(d).

(2) Decision Timeframes. The Review Authority shall approve or deny the housing development within the following applicable period:

- (a) 90 days from Environmental Impact Report certification;
- (b) 60 days from Environmental Impact Report certification for an affordable housing development consistent with Government Code §65950(a)(3);
- (c) 60 days from adoption of a Negative Declaration; or
- (d) 60 days from determination of CEQA exemption.

H. Post-Decision Procedures. Post-decision procedures for the required permit (full application) shall be followed provided those procedures do not conflict with applicable Government Code sections for housing developments (i.e., Housing Accountability Act, Government Code §65589.5).

This page intentionally left blank

Figure 10.020.1: Process for Developments Eligible for Senate Bill 35 Streamlining with 150 units or Fewer (Government Code §65913.4)

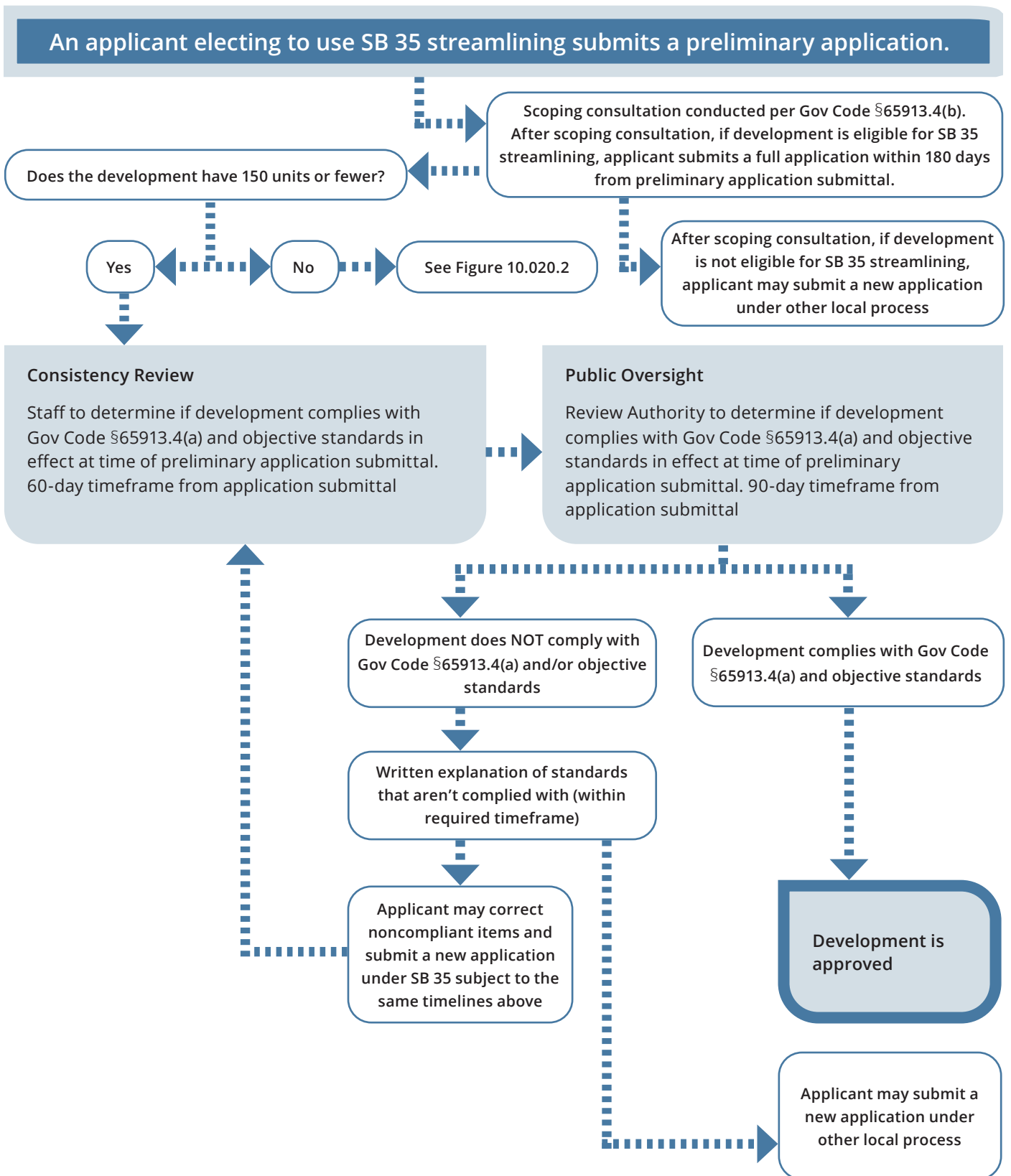

Figure 10.020.2: Process for Developments Eligible for Senate Bill 35 Streamlining with 151 units or More (Government Code §65913.4)

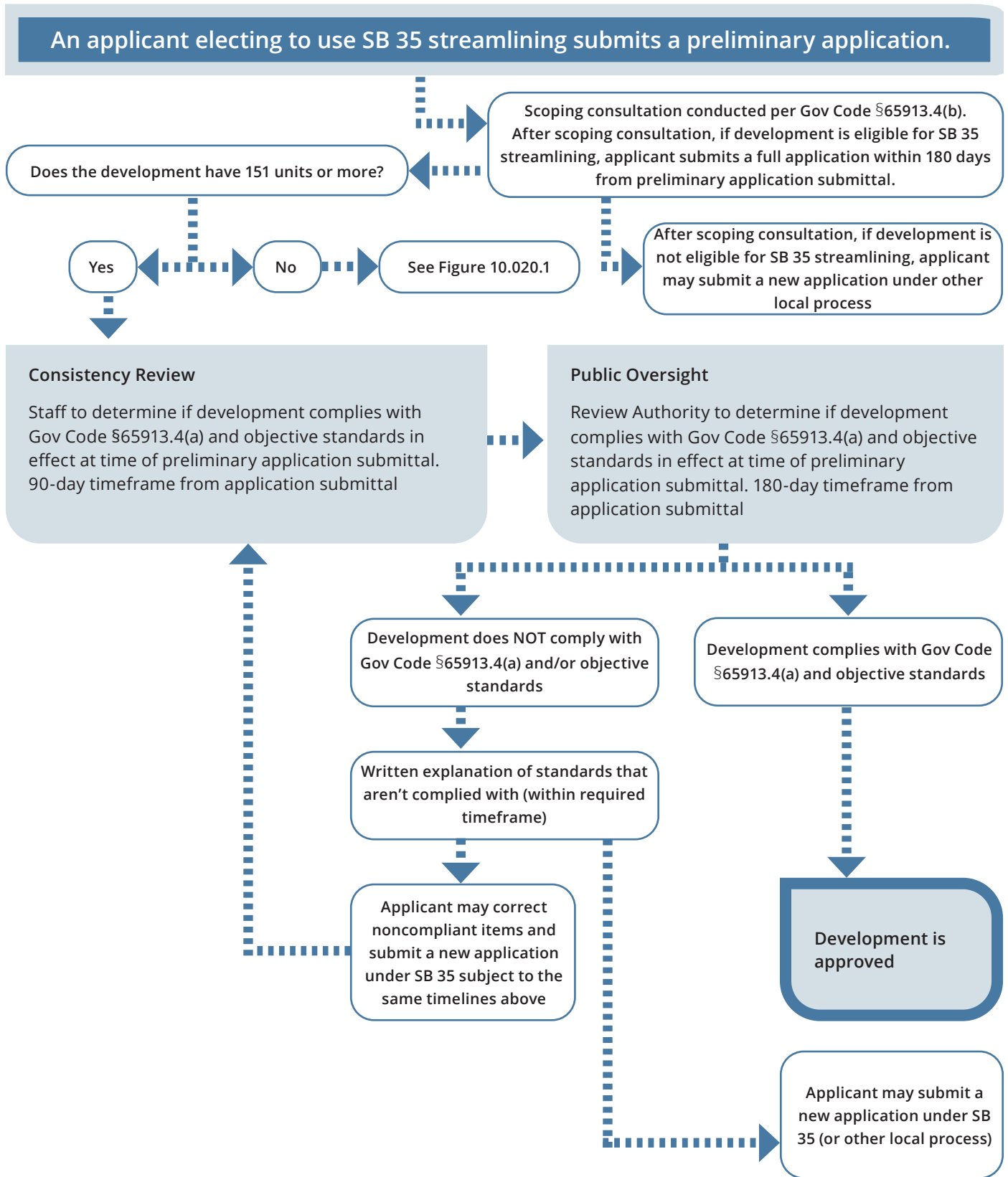
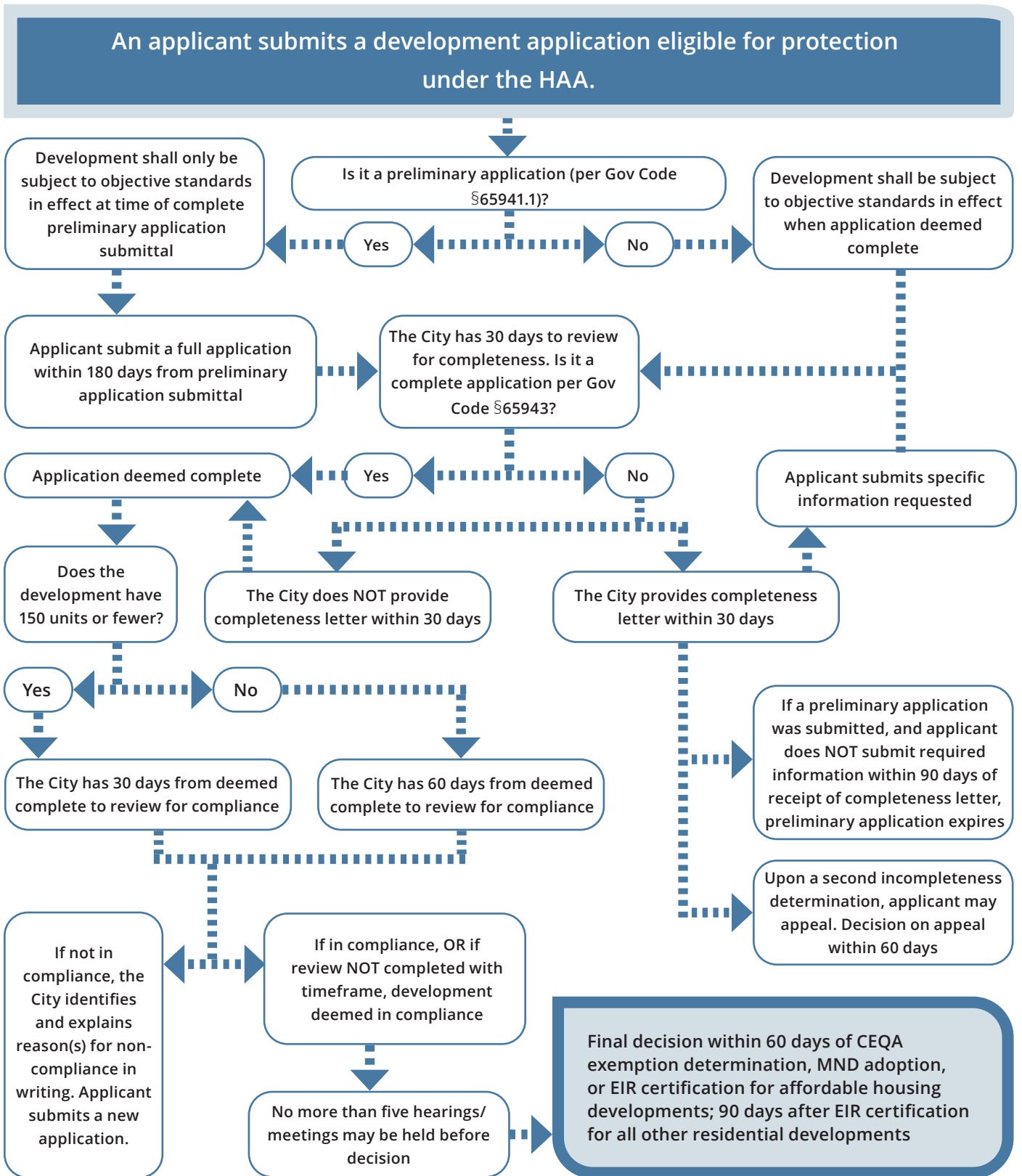

Figure 10.020.3: Process for Developments Eligible for Housing Accountability Act (HAA) Protection (Government Code §65589.5)



10.030 Adjustments to Standards

1. **Purpose.** This Section is intended to allow for minor deviations from certain standards in this ODS for specific situations because of the prescriptive nature of the standards.
2. **Applicability.** This Section applies to developments subject to Section 10.020 (Procedures). The Review Authority may grant an Adjustment for only the standards identified as follows:
 - A. Design sites less than 6% slope. See Table A (Adjustments to Standards for Design Sites Less Than 6% Slopes).
 - B. Design sites over 6% slope. See Table B (Adjustments to Standards for Design Sites Over 6% Slopes).
3. **Procedures.** Adjustment requests shall be reviewed and processed as follows:
 - A. If the development for which an Adjustment is requested is being processed consistent with Section 10.020 (Procedures), the Adjustment shall be processed concurrently and consistent with the applicable procedures in Section 10.020 (Procedures); or
 - B. If the development for which an Adjustment is requested beyond what is authorized in Table A (Adjustments to Standards for Design Sites Less Than 6% Slopes) and Table B (Adjustments to Standards for Design Sites Over 6% Slopes), the adjustment will be processed only up to the amount authorized in these Tables.
 - C. Adjustment requests involving any of the following features (i.e., historic building/feature, tree, rock outcrop, and/or utility infrastructure) shall be accompanied by existing conditions documentation identifying the feature(s).
 - D. Depending on the unique characteristics and dimensions on an individual parcel, it is possible that the full development potential of the district may not be achievable even after applying the allowed adjustments in this Section.
 - E. Adjustments may not be used in conjunction with Density Bonus incentives/concessions to adjust these Standards.

Table 10.030.A: Adjustments to Standards for Design Sites with Less than 6% Slope

Administrative Relief Type	Required Criteria (All that Apply)	Allowed Administrative Relief and Requirements²	Reference to Standard
1. Design Site Dimensions			
a. Depth or Width Decrease in the minimum required or increase in the maximum allowed	i. The critical root zone of a protected tree, utility infrastructure that is not required to be removed, relocated, or undergrounded, or a historic building/feature prevents compliance with the standard.	Up to 25% of the standard	Subsection 3 of the district
2. Building Setbacks			
a. Front¹, Secondary Front Yard¹, or Side Decrease in the minimum required setback or increase in the maximum required setback for a primary building and/or wing(s)	i. The critical root zone of a protected tree, utility infrastructure that is not required to be removed, relocated, or undergrounded, or a historic building/feature prevents compliance with the standard.	Front or Secondary Front Yard: Up to 25% of the standard Side: Reduced to 3'	Subsection 5 of the district
b. Facade within Facade Zone¹ Decrease in the minimum amount of facade required within or abutting the facade zone	i. The critical root zone of a protected tree, utility infrastructure that is not required to be removed, relocated, or undergrounded, or a historic building/feature prevents compliance with the standard.	Up to 10% of the standard The horizontal unbuilt area resulting from this adjustment is landscaped/hardscaped per the standards in Section 4.030 (Landscaping and Lighting).	Subsection 5 of the district
3. Building Footprint			
a. Size of Main Body¹ or Wing(s) Increase in the allowed width or length	i. The critical root zone of a protected tree, utility infrastructure that is not required to be removed, relocated, or undergrounded, or a historic building/feature prevents compliance with the standard.	Up to 15% of the standard In T3NE and T4N.S districts, the wing(s) is one-storey less in height than the main body. The building complies with the setbacks of the district or as allowed to be adjusted by this Section.	Subsection 3 of the building type
b. Depth of Ground Floor Habitable Space	i. If existing parcel is less than 100' in depth	20' minimum	Subsection 4 of the district

¹Standards for private frontage apply [See Chapter 6 (Specific to Private Frontages)], and any adjustment shall not preclude the application of a private frontage type.

²Adjustment of the identified standards in Table A shall be only to the extent necessary to achieve compliance with the standards.

Table 10.030.B: Adjustments to Standards for Design Sites Over 6% Slope

Administrative Relief Type	Required Criteria (All that Apply)	Allowed Administrative Relief and Requirements ²	Reference to Standard
1. Design Site Dimensions			
a. Depth Increase or decrease in minimum to maximum design site depth	<ul style="list-style-type: none"> i. Existing slope exceeds 15% grade for at least 50% of design site depth. ii. If an adjustment is granted for an increase in the Main Body and/or Rear wing resulting in the need to change the development site depth, the development site depth may increase as allowed in this Section. 	Up to 25% max. of the standard	Subsection 3 of the district
b. Width Increase or decrease in minimum to maximum design site width	<ul style="list-style-type: none"> i. Existing slope exceeds 15% grade for at least 25% of design site width. ii. If an adjustment is granted for an increase in the main body and/or rear wing results in the need to change the development site width, the design site width max. increase as allowed in this Section. 	Up to 25% max. of the standard	Subsection 3 of the district
2. Building Setbacks			
a. Front¹, Secondary Front Yard¹, Side or Rear Increase or decrease in minimum to maximum required setback areas for primary building and/or wing(s)	<ul style="list-style-type: none"> i. Existing slope exceeds 20% grade within at least the front and/or rear 30' of design site depth. ii. The critical root zone of a protected tree, utility infrastructure that is not required to be removed, relocated, or undergrounded, or a historic building/feature prevents compliance with the standard. iii. The existing lot depth is less than 80'. 	<p>Front: Project exempt from facade zone. Rear: Decrease minimum setback to 5'.</p> <p>In T3 NE and T4N.S, where secondary front yard setback is 10' minimum, decrease minimum setback to within 5' of the design site line.</p> <p>Decrease in the rear minimum setback to 10' and maximum 1 story or 15' minimum setback for at least 2 stories.</p>	Subsection 5 of the district

¹ Standards for private frontage apply [See Chapter 6 (Specific to Private Frontages)], and any adjustment shall not preclude the application of a private frontage type.

² Adjustment of the identified standards in Table A shall be only to the extent necessary to achieve compliance with the standards.

Missed Edit(s):

1. Updated text to clarify total retaining wall height relief for front, side, and rear
2. Updated reference

Table 10.030.B: Adjustments to Standards for Design Sites Over 6% Slope (Continued)

Administrative Relief Type	Required Criteria (All that Apply)	Allowed Administrative Relief and Requirements²	Reference to Standard
3. Site Grading			
a. Retaining Wall (Height) Increase in maximum retaining wall height or length	<ul style="list-style-type: none"> i. Existing slopes exceed 15% grade for at least 50% of design site width or depth. ii. The retaining wall or series of retaining walls cannot be seen from the adjacent public sidewalk or adjacent property. iii. Retaining walls not within the building footprint are less than 50' in total length along the rear design site line or any design site line. 	Increase in retaining wall height up to 2' in addition over max. retaining wall height along rear and/or side design site line(s) : front up to 6', side up to 5', rear up to 10'; Increase in retaining wall height up to 20' within the building footprint	Subsection 4.050.5 03.4.D
4. Block Face and Perimeter			
a. Increase in maximum length of new or modified block	<ul style="list-style-type: none"> i. Existing slope along at least one side of the block exceeds 15% grade, resulting in new street(s) that exceed maximum allowed grade, preventing compliance with the standards. 	Increase in block face that is enough to maintain compliance with the maximum 15% grade for new streets. Block face(s) exceeding the maximum allowed by Chapter 9 (Specific to Large Sites) shall include a Passage or other thoroughfare type to maintain compliance with the block standards.	Table 9.020.A (Block Size Standards)

¹ Standards for private frontage apply [See Chapter 6 (Specific to Private Frontages)], and any adjustment shall not preclude the application of a private frontage type.

² Adjustment of the identified standards in Table A shall be only to the extent necessary to achieve compliance with the standards.

Table 10.030.B: Adjustments to Standards for Design Sites Over 6% Slope (Continued)

Administrative Relief Type	Required Criteria (All that Apply)	Allowed Administrative Relief and Requirements ²	Reference to Standard
5. Parking Location			
<p>a. Front or Secondary Front Yard Setbacks Decrease in a required parking setback.</p>	<p>One or more of the following techniques are applied, as allowed by this Section:</p>		
	<p>i. Surface: Parking is uncovered and located between the building and the street. The existing lot depth is less than 80', and the site exceeds 15% for at least 50% of the site depth.</p>	<p>Parking is allowed in the front setback for up to 50% of the site's width along the adjacent thoroughfare.</p>	<p>Subsection 7 of the district; Subsection 4 of the district</p>
	<p>ii. Podium: Parking under primary building is enclosed and access is only from one side of the design site for design sites 150' or less in width. Habitable space, required in Subsection 4 of the district as allowed to be reduced by this Section, is between the front of the building and the parking spaces. The parking garage access is not greater than 25' in width.</p>	<p>Front Setback: Decrease to 18' behind the primary building facade with no limitation to site width. Secondary Front Yard Setback: Decrease to 5' behind the primary building facade.</p>	
	<p>iii. Tandem Parking: Tandem parking spaces may be arranged in a series of up to 3 total parking spaces from the front design site line, and up to 3 side-by-side, for up to half of the design site width along the abutting thoroughfare.</p>	<p>Habitable Space: Decrease in the minimum depth to 15'.</p>	
	<p>iv. Subterranean Parking: Parking spaces are located below the adjacent finished grade of the building to the district's building setbacks. The garage access is not greater than 25' in width.</p>	<p>All Setbacks: Decrease to match the building setbacks of the district or as allowed to be reduced by this Section.</p>	
	<p>v. Stacked Parking System: Parking spaces are arranged in a system that provides up to 3 spaces in the horizontal area of one space. The garage access is not greater than 25' in width.</p>	<p>Front and/or Secondary Front Yard Setback: Decrease to be the same as the primary building setback. Decrease in the minimum habitable space depth to 18'.</p>	

¹Standards for private frontage apply [See Chapter 6 (Specific to Private Frontages)], and any adjustment shall not preclude the application of a private frontage type.

²Adjustment of the identified standards in Table A shall be only to the extent necessary to achieve compliance with the standards.

Chapter 11: Definitions

Sections:

11.010	Purpose
11.020	Definitions
11.030	Measurement Methods

11.010 Purpose

This Chapter provides definitions for specialized terms and phrases used in this ODS. All other applicable definitions in Chapter 17.08 (Definitions) of Title 17 (Zoning) apply.

11.020 Definitions

A. Definitions

Abandoned Sign. A sign in place for a period of at least 90 days which no longer advertises an ongoing business, lessor, owner, or activity on the premises where the sign is displayed.

Abutting. Having a common property line or district boundary, or separated by a private or public street or easement.

Access or Service Drive. A public or private way of paving or right-of-way of not more than 30 feet affording means of access to property.

Access Frontage or Service Road or Street. A public or private street or right-of-way of not less than minimum standards as specified by the subdivision ordinance of the the City of Sebastopol affording means of access to property.

Accessory Dwelling Unit (ADU). An attached or detached residential dwelling unit which provides complete living facilities for one or more persons, including permanent provisions for living, sleeping, eating, cooking, and sanitation, which is located on the same parcel as a single-unit dwelling.

Accessory Structure (syn. Accessory Building). A structure physically detached from, secondary and incidental to, and commonly associated with a primary structure or use on the same site. Accessory structures normally associated with a residential use property include, but are not limited to: garages (unenclosed or enclosed) for the storage of automobiles (including incidental restoration and repair), personal recreational vehicles, and other personal property; studios; workshops; greenhouses (noncommercial); enclosed cabanas and pool houses; and storage sheds. Accessory structures normally associated with a non-residential use property include, but are not limited to: garages (unenclosed or enclosed) for the storage of automobiles and work related vehicles and equipment (including incidental restoration and repair); storage structures; workshops; and studios.

Accessory Structure, Major (Major Accessory Structure). An accessory structure with a footprint greater than 120 square feet.

Accessory Structure, Minor (Minor Accessory Structure). An accessory structure with a footprint of 120 square feet or less.

Addition. The enlargement of an improvement accomplished by appending a new improvement.

Adjacent. Sharing a common design site line, or having design site lines separated only by an alley.

Adjacent Buildings. Two or more buildings located upon adjacent design sites.

Affordable to Low-Income or Very-Low-Income Households. Being of a condition in which sales prices or rental rates for a housing development conform with the current "Inclusionary Housing Requirements," established by resolution of the Sebastopol City Council.

Affordable Housing Development. A residential development consisting of five or more units, not including any bonus units requested, in which

- a. At least 20 percent of the total units are affordable to low-income households;
- b. At least 10 percent of the total units are affordable to very-low-income households; or
- c. At least 50 percent of the total units are senior housing (Government Code §65915(b) and Civil Code §51.2 and §51.3).

Aggregate Sign Area. The total area of all signs and/or all messages located on a design site.

Alley. A public or private way to be used primarily for vehicular access to the back or side of a design site of real property that otherwise abuts a street.

Alter. To create physical change in the internal arrangement of rooms or the supporting members of a structure, or a change in the external appearance of any structure, not including painting.

Ancillary Structure (syn. Ancillary Building). See "Accessory Structure."

Apartment, Efficiency. A dwelling unit in a multi-unit building, consisting of not more than one habitable room, excluding the kitchen or kitchenette and sanitary facilities, of a total floor area of not more than 400 square feet.

Applicant. Any individual, firm, or any other entity that applies to the City for the applicable permits to undertake any construction or development within the City.

Architectural Feature. Exterior building element intended to provide ornamentation to the building massing including, but not limited to: eaves, cornices, bay windows, window and door surrounds, light fixtures, canopies, and balconies.

Attached Building or Structure. Any building or structure which is structurally a part of or has a common wall and/or continuous roof with a primary building or structure, except where such connection is a breezeway or walkway incidental to and not a necessary part of the construction of the primary building.

Average Slope. The result of dividing the length of a slope by the difference in elevation at the top and bottom of the slope. See Subsection 11.030.1.C.

Awning. A roof or cover which projects from a wall of a building over a window or door, made of canvas, aluminum, or similar material, which may be fixed in place or be retractable.

Awning Sign. See Section 8.060 (Awning/Canopy Sign).

B. Definitions

Banner Sign. A sign made of a flexible material that projects or hangs from a building, structure, pole, or wire. A banner sign includes flags but does not include pennants.

Base Flood Elevation. As designated by Federal Emergency Management Agency (FEMA), the elevation of surface water resulting from a flood that has a one percent chance of equaling or exceeding that level in any given year.

Basement. A story whose floor is more than 12 inches, but not more than half of its story height below the average level of the adjoining finished grade (as distinguished from a "cellar," which is a story more than one-half below such level). A basement, when used as a dwelling, shall not be counted as a story for purposes of height measurement.

Bathroom. A room that contains all of the following features: a bathtub or shower, a washbowl, and a toilet.

Bay. Any division of a building between vertical lines or planes, especially the entire space included between two adjacent supports. See Subsection 11.030.4 for measurement method.

Bay Window. An architectural projection from the building cantilevered from the facade, consisting of one or more stories in height, containing at least 60 percent glass area. Window opening that includes an opening on each side.

Billboard Sign. An off-site sign which is supported by one or more uprights, poles, or braces in or upon the ground, other than a freestanding sign, monument sign, or pole sign.

Bird-safe Pattern. A pattern on the glass intended to reduce bird collisions. The pattern must be visible to birds from the exterior of the building and have lines, circular, or square markers at least 0.25 inches in width or diameter, spaced at most four inches apart vertically and two inches apart horizontally.

Bird Safety Treatment. Building treatments or methods to reduce the likelihood of bird collisions. These treatments must include at least one or a combination of the following - exterior screens, louvers, grilles, shutters, or bird-safe patterns as recommended by the American Bird Conservancy.

Block. An area of land separated from other areas by adjacent streets, railroads, rights-of-way, public areas, or the subdivision boundary.

Block Face. The aggregate of all the building facades on one side of a block. The block face provides the context for establishing architectural harmony.

Block Length. The horizontal distance from the right-of-way on one end of the block to the right-of-way on the other end along the same street.

Block Perimeter. The aggregate of all sides of a block bounded by the abutting rights-of-way.

Block-Scale, Building. A building that is individually as large as a block or individual buildings collectively arranged along a street to form a continuous facade as long as most or all of a block.

Bonus. See "Density Bonus."

Bracket Sign. See "Projecting Sign."

Building. A structure consisting of one or more foundations, floors, walls, and roofs that surround an interior space, and may include exterior appurtenant structures including, but not limited to, porches and decks.

Buildable Area. The horizontal area in which a building is allowed to be constructed.

Building Elevation. The exterior wall of a building not adjacent to a public right-of-way, the front or side along a private street, or open space.

Building Entrance. A point of pedestrian ingress and egress to the front of a building along the sidewalk of the street immediately adjacent to the building.

Building, Existing. See "Structure, Existing."

Building Facade. The exterior wall of a building adjacent to a street, the front or side along a private street, or open space.

1. **Building Facade, Front.** The exterior wall of a building adjacent to a street or open space.
2. **Building Facade, Secondary Front Yard.** The exterior wall of a building adjacent to a secondary front yard.
3. **Building Facade, Interior Side.** The exterior wall of a building adjacent to the interior design site line(s).
4. **Building Facade, Rear.** The exterior wall of a building opposite the front.

Building Form. The overall shape and dimensions of a building.

Building Frontage. The facade(s) along the front and secondary front yard of the design site.

Building Frontage, Principal. The facade along the front of the design site, typically the narrower of sides and identified by an address.

Building, Primary. The building that serves as the focal point for all activities related to the principal use of the design site.

Building, Setback. See "Setback, Building."

Building Signs. Any sign that is fastened, attached, connected, or supported in whole or in part by a building or architectural feature.

Building Type. A structure defined by its combination of configuration, disposition, and function.

By-Right, Approval. Approval by administrative staff of certain uses, improvements, and developments not requiring further review and in compliance with all applicable standards.

C. Definitions

Canopy Sign. See Section 8.060 (Awning/Canopy Sign).

Carshare Parking Space. A parking space required to be dedicated for current or future use by a carshare service through a deed restriction, condition of approval, or license agreement. Such deed restriction, condition of approval, or license agreement shall grant priority use to any carshare service that can make use of the space, although such spaces may be occupied by other vehicles so long as no carshare organization can make use of the dedicated carshare space(s).

Carshare Service. A service that provides a network of motor vehicles available to rent by members by reservation on an hourly basis or in smaller intervals.

Catering service. A businesses that prepares food for consumption on the premises of a client.

Ceiling Height, Ground Floor. The height from finished floor to finished ceiling of primary rooms on the ground floor, not including secondary rooms which include, but are not limited to: bathrooms, closets, utility rooms, and storage spaces.

Ceiling Height, Upper Floor(s). The height from finished floor to finished ceiling of primary rooms on the floor(s) above the ground floor, not including secondary rooms which include, but are not limited to: bathrooms, closets, utility rooms, and storage spaces.

Cellar. That portion of a building between floor and ceiling which is wholly or partly below grade and so located that the vertical distance from grade to the floor below is equal to or greater than the vertical distance from grade to ceiling. A cellar shall not be counted as a story, for the purpose of height standards.

Center. Concentration of ground floor shopping, restaurants, and services, with additional offices and housing located above, within a Walkable Urban context.

Chamfered. A transitional edge between two faces of an object. Sometimes defined as a form of bevel, it is often created at a 45° angle between two adjoining right-angled faces.

Chamfered Facade Corner. An external wall of a building joining two perpendicular exterior walls, typically at a symmetrical, 45 degree angle creating a beveled edge to the building rather than a 90 degree corner.

Changeable Copy Sign(s). See Section 8.120 (Changeable Copy Sign).

Civic. A term defining not-for-profit organizations that are dedicated to arts, culture, education, religious activities, recreation, government, transit, and public parking facilities.

Civic Building. A structure operated by governmental or not-for-profit organizations and limited to civic and related uses.

Commercial Signage. Any sign sponsored by a commercial entity and whose prevailing message proposes a commercial transaction.

Common Courtyard. An entry court, forecourt, or courtyard shared by multiple residential units or commercial spaces.

Common Open Space. An entry court, forecourt, courtyard, or other on-site open space shared by multiple residential units or non-residential units.

Common Space (syn. Common Area). A portion of a development held in common and/or single ownership, is not reserved for the exclusive use or benefit of an individual tenant or owner, and is available for use by all persons who reside or work in the building or on the design site.

Communication Equipment Building. A building housing operating electrical and mechanical equipment necessary for the conduct of a communications business with or without personnel.

Communications Tower. Any structure which supports an antenna.

Community Center. A multi-purpose meeting and recreational facility typically consisting of one or more meeting or multi-purpose rooms, kitchen, and/or outdoor barbecue facilities, that are available for use by various groups for such activities as meetings, parties, receptions, dances, etc.

Condominium. An estate in real property consisting of an undivided interest in common in a portion of the property together with a separate interest in space called a unit, the boundaries of which are described on a recorded final map, design site map, or condominium plan. The condominium may be commercial, industrial, residential, or any combination. [Civil Code §783, §1351(f)].

Condominium Conversion. The conversion of an existing structure into separately owned commercial, industrial, or mixed-use units.

Corner Element. A physical distinction in a building at the corner of two streets or a street and public space.

Corner Entry. An entrance located on the corner of a building.

Cornice. The crown molding of a building or element.

Cottage Court. See Section 5.080 (Cottage Court).

Council. The City Council of the City of Sebastopol.

Courtyard (syn. Court). An unroofed area that is completely or partially enclosed by walls or buildings on at least two sides and often shared by multiple residential units or non-residential units, not including off-street parking. See Subsection 11.030.3.A.(4) for measurement method.

Courtyard Building, Neighborhood and Core. See Section 5.110 (Neighborhood Courtyard) and Section 5.150 (Core Courtyard).

Coverage

1. **Coverage, Accessory Structures.** The sum of the footprint area of all structures on a design site.
2. **Coverage, Building.** The floor area of the largest story of a building divided by the total design site area.
3. **Coverage, Design Site.** The portion of the design site expressed as a percentage that is covered in buildings or other structures.

Co-working Space. A facilitated environment which may contain shared facilities including, but not limited to: conference rooms, reception services, phones, and other business amenities. Work spaces are used by a recognized membership who share the site in order to interact and collaborate with each other as part of a community and to reduce duplicated costs by sharing facilities. The uses shall have externally observable attributes similar to uses allowed in the zone in which that they are located. Equipment is limited to those which do not generate noise or pollutants in excess of what is customary within a typical office environment. Such space located in a research & development building may use equipment consistent with research & development uses. Co-working space may be interchangeably referred to as "incubator space."

Cul-de-sac. A street which connects to another public street only at one end and is not planned for later extension.

Crawl Space. A shallow unfinished uninhabitable space beneath the floor or under the roof of a building, that provides access to utility, structural, and other building components not readily accessible from the habitable portions of the building.

Crenel. A notch between two merlons (solid upright section of a crenellated parapet), often found in medieval architecture.

Crenellated. Having regularly-spaced, often rectangular gaps, often referring to a parapet or battlement in medieval architecture.

Crenellation. The series of regularly-spaced, often rectangular crenels along a parapet.

D. Definitions

Dangerous or Objectionable Elements. Any land or building structure used or occupied in any manner so as to create any dangerous, injurious, noxious, or otherwise objectionable fire, explosive, or other hazard; noise or vibration, smoke, dust, odor, or other form of air pollution; heat, cold, dampness, electrical, or other disturbance; glare; liquid or solid refuse or wastes; or other substance, condition or elements in such manner or in such amount as to adversely affect the surrounding area or adjoining premises.

Days. Calendar days unless this ODS specifies otherwise.

Dedication. The transfer by a subdivider to a public entity of title to real property or an interest therein, or of an easement or right in real property, the transfer of facilities, the installation of improvements, or any combination of these. See Section 16.36.030 (Dedications)

Defensible Space. A public, private, or semi-private residential environment whose physical characteristics—building layout and site plan—function to allow inhabitants themselves to become key agents in ensuring their security.

Density Bonus. A density increase over the maximum allowable residential density of the zone. See Government Code §65915-65918 for types of bonuses.

Dentils. Small, rectangular blocks found under a cornice in classical architecture. A decorative element, dentils bear resemblance to teeth, their namesake.

Department. The City's Planning Department.

Depth, Ground-Floor Space. The distance from the street-facing facade to the rear interior wall of the ground-floor space available to an allowed use.

Depth-to-Height Ratio. The relationship of the depth of a space measured perpendicular to a building divided by the average height of the buildings adjacent to the space.

Design Site. A portion of land within a parcel, delineated from other design sites and/or parcels to accommodate no more than one building type. The main purpose of a design site is to allow a parcel large enough to contain more than one building type to contain multiple building types while not requiring the legal subdivision of the parcel into additional parcels.

1. **Design Site, Corner.** A design site located at the intersection of two or more streets, where they intersect at an interior angle of not more than 175 degrees. If the intersection angle is more than 175 degrees, the design site is considered an interior design site.
2. **Design Site, Flag.** A design site not meeting minimum design site frontage standards and where access to a public or private street is provided by means of a long, narrow driveway between abutting design sites.
3. **Design Site, Interior.** A design site abutting only one street.
4. **Design Site, Through.** A design site with two or more frontage lines that do not intersect.

Design Site Area. The total square footage or acreage of horizontal area included within the design site lines.

Design Site Coverage. See "Coverage."

Design Site Depth. The horizontal distance between the front design site line and rear design site line of a design site measured perpendicular to the front design site line.

Design Site Line. The perimeter and geometry of a design site demarcating one design site from another.

1. **Design Site Line, Front.** One of the following:
 - a. The frontage line in the case of a design site having a single frontage line;
 - b. The shortest frontage line in the case of a corner design site with two frontage lines, neither of which are adjacent to a thoroughfare or a design site with independent frontage;
 - c. The frontage line generally perceived to be the front design site line in the case of a corner design site with three or more frontage lines, none of which are adjacent to a thoroughfare or a design site with independent frontage;
 - d. The frontage line adjacent to a thoroughfare in the case of a corner design site with two or more frontage lines, one of which is adjacent to a thoroughfare;
 - e. The frontage line adjacent to a design site with independent frontage in the case of a corner design site with two or more frontage lines, one of which is adjacent to a design site with independent frontage; or
 - f. The frontage line adjacent to the front design site line of an adjacent design site in the case of a through design site.
2. **Design Site Line, Rear.** That design site line opposite the front design site line.
3. **Design Site Line, Side.** Design site lines connecting the front and rear design site lines.

Design Site Width. The horizontal distance between the design site lines measured perpendicular to the front design site line.

Detached. Separate or unconnected.

Development Site. The parcel(s) or portion(s) thereof on which proposed structures and improvements are to be constructed.

Dilapidated Sign. A sign that is no longer in a good state of repair or constitutes a health or safety hazard.

Diligently Pursued. Continued with constant or appropriate effort.

Director. Director of Sebastopol's Planning Department, an appointed representative.

Directory Sign(s). See Section 8.110 (Directory Sign).

Display. An item or arrangement of items indoors that is not attached to a window, door or wall.

Disposition, Formal. Composed in a formal arrangement, in a regular, classical, and typically symmetrical manner.

Disposition, Informal. Composed in an informal character with a mix of formal and natural characteristics.

Disposition, Natural. A preservation of the existing natural condition or a composition of elements arranged as they would appear in nature, with irregular shapes and asymmetry.

Distance Between Entries. The horizontal distance between entrances to a building or buildings, measured parallel to the facade.

District. See "Transect Zone."

Driveway. A vehicular lane within a design site, or shared between two design sites, usually leading to a garage, other parking, or loading area.

Duplex Side-by-Side. See Section 5.060 (Duplex Side-by-Side).

Duplex Stacked. See Section 5.070 (Duplex Stacked).

Dwelling, Group Living (syn. Cohousing). Dwellings designed for occupancy of groups living together and having a central dining facility.

Dwelling, Multiple. A building designed or used for three or more dwelling units.

Dwelling, Second Unit. A separate, complete housekeeping unit with a separate entrance, kitchen, sleeping area, and full bathroom facilities, which is an attached or detached extension to an existing single-unit structure.

Dwelling Unit. A room or group of internally connected rooms that have sleeping, cooking, eating, and sanitation facilities, but not more than one kitchen, which constitute an independent housekeeping unit, occupied by or intended for one household on a long-term basis.

Dwelling Unit, Stacked. A dwelling unit situated immediately above or below another dwelling unit.

E. Definitions

Eave. The edge of the roof that overhangs the face of the adjoining wall. The bottom of the eave can range from exposed rafters ("open eave") to a finished horizontal surface ("closed eave").

Electric Sign. A sign containing electrical circuits, but not including signs illuminated by an exterior light source.

Elevated Ground Floor. A ground floor situated above the grade plane of the adjacent sidewalk.

Encroachment. Any architectural feature, structure, or structural element—including, but not limited to, a gallery, fence, garden wall, porch, stoop, balcony, bay window, terrace, or deck—that breaks the plane of a vertical or horizontal regulatory limit by extending: into a setback, beyond the build-to-line into the public frontage, or above a height limit.

Entablature. Syn. Expression Line. A horizontal, continuous lintel on a classical building supported by columns or a wall, comprising the architrave, frieze, and cornice.

Entasis. A slight convex curve in the shaft of a column, introduced to correct the visual illusion of concavity produced by a straight shaft.

Entry. An opening, including, but not limited to, a door, passage, or gate, that allows access to a building.

1. **Entry, Primary.** The opening that allows access to a building directly from the sidewalk along the front facade.
2. **Entry, Service.** An entrance located toward or at the rear of the building intended for the delivery of goods and removal of refuse.

Established Landscape. The point in time at which plants have developed roots into the soil adjacent to the root ball.

Establishment Period. The first year after installing a plant in a landscape.

Existing Structure. For the purpose of defining an allowable space that can be converted to an accessory dwelling unit means within the four walls and roofline of any structure existing on or after [Month, Year](#) that can be made safely habitable in compliance with local building codes at the determination of the [Building Official](#) regardless of any noncompliance with this ODS.

External Employees. An employee who does not reside at his or her place of employment.

F. Definitions

Facade. See "Building Facade."

Facade Zone. The area between the minimum and maximum setback lines along the front of a design site and along the secondary front yard of a corner design site where the building facade is required to be placed. The district standards identify the minimum amount of facade to be placed in the facade zone. See Subsection 11.030.2 for measurement method.

Facility. An improvement, structure, or building that is designed and used for a particular purpose.

Fence. A structure, made of wood, metal, masonry, or other material, typically used to screen, enclose, or divide open space for a setback or along a design site line.

Finish Level, Ground Floor. Height difference between the finished floor on the ground floor and the adjacent sidewalk. In the case of a terrace frontage that serves as the public right-of-way, the floor finish level is the height of the walk above the adjacent street. Standards for ground floor finish level for ground floor residential uses do not apply to ground floor lobbies and common areas in multi-unit buildings.

Flex Space. A room or group of internally connected rooms designed to accommodate an evolution of use over time in response to an evolving market demand. Typically designed to accommodate future commercial uses, while accommodating less intense short-term uses, including, but not limited to, residential or live/work, until the commercial demand has been established.

Flood Hazard. The threat of overflow stormwaters having the capability to flood lands or improvements, transport or deposit debris, scour the surface soil, dislodge or damage structures, or erode the banks of channels.

Floor Area. The sum of the gross areas of all stories of a building, measured from the exterior faces of the exterior walls. The floor area shall include any building that has a roof and is enclosed so as to provide shelter from the elements on three or more sides.

Floor to Lot Area Ratio. The floor area of the building divided by the total design site area.

Floor Coverage. See "Coverage."

Floorplate. An area measurement in square feet of either the gross or the rentable floor area of a typical floor in a building.

Floorplate, Commercial. The square footage area measurement of a floorplate dedicated to commercial uses.

Floorplate, Non-residential. The square footage area measurement of a floorplate dedicated to non-residential uses.

Floorplate, Residential. The square footage area measurement of a floorplate dedicated to residential uses.

Flow Rate. The rate at which water flows through pipes and valves, measured in gallons per minute or cubic feet per second.

Footprint Area. The total square footage contained within a footprint.

Footprint, Building. The outline of the area of ground covered by the foundations of a building or structure.

Forecourt. See Section 06.080 (Forecourt).

Form-Based District (syn. Transect District). One of several districts mapped on the Form-Based District Map applicable only to qualifying development projects using Objective Design Standards found in Article 2 (Objective Design Standards). See District Map.

Freestanding Sign. A sign supported entirely or in part by the ground, including, but not limited to, a monument, pole, or similar sign.

Freestanding Wall. A wall that is separate from a building and supported by independent means.

Front. See "Design Site Line, Front."

Front Loaded. (Front Access). Design sites that provide vehicular access from the front of the design site.

Frontage, Private. The area between the building facade and the back of the sidewalk abutting a street (public or private) or open space.

Frontage, Public. The area between the on-street parking and the back of the sidewalk.

Frontage Line. The design site line(s) of a design site fronting a street (public or private) or a open space.

Frontage Type. A physical element configured to connect the building facade to the back of the sidewalk abutting a street or open space depending on the intended physical character of the district.

Furniture Area. An area of space that allows for the placement of furniture without restricting the movement of pedestrians.

G. Definitions

Gable. A vertical wall in the shape of a triangle formed between the cornice or eave and the ridge of the roof.

Gallery. See Section 06.120 (Gallery).

Ganged. Refers to windows designed/found in an array of two or more.

Garage. A structure, or part thereof, used or intended to be used for the parking and storage of motor vehicles.

1. **Garage, Private.** A building or portion of a building, in which only motor vehicles used by the tenants of the building or buildings on the premises are stored or kept.
2. **Garage, Public.** A structure or portion thereof, other than a private garage, used for the storage, sale, hire, care, minor or major repair, or refinishing of self-propelled vehicles or trailers; except, that a structure or part thereof used only for storage or display of self-propelled passenger vehicles, but not for transients, and at which automobile fuels and oils are not sold and motor driven vehicles are not equipped, repaired, or hired, shall not be deemed to be a public garage

Glazing. Openings in a building in which glass is installed.

Grade. The finished ground level at any point along the exterior walls of a structure. Where walls are parallel to and within five feet of a sidewalk, alley or other public way, the level above ground shall be measured at the elevation of the sidewalk, alley or public way. Also see "Grade, Finished."

Grade, Finished. The final ground surface elevation after the completion of grading or other site preparation related to a proposed development that conforms to an approved Grading Permit or Building Permit. In cases where substantial fill is proposed, "finished grade" shall be established by the Director consistent with design sites in the immediate vicinity and shall not be, nor have been artificially raised to gain additional building height. Also see "Grade."

Grade, Pre-Development. The grade of a design site prior to any site improvements related to the proposed development.

Grading. Earthwork performed to alter the natural contours of an area.

Green Building Practices. A whole-systems approach to the design, construction, and operation of buildings and structures that helps mitigate the environmental, economic, and social impacts of construction, demolition, and renovation. Green building practices including, but not limited to, those described in the LEED™ rating system recognize the relationship between natural and built environments and seek to minimize the use of energy, water, and other natural resources and provide a healthy, productive environment.

Ground Floor. The floor of a building located nearest to the level of the ground around the building.

Gross Floor Area. The total floor area inside the building envelope, including the external walls, but not including the roof.

Ground Floor Ceiling Height. Height from finished floor to finished ceiling of primary rooms on the ground floor, not including secondary rooms including, but not limited to: bathrooms, closets, utility rooms, and storage spaces.

Gross Parking Area. The total area of parking space and drive included on a design site.

Gross Residential Acreage. The total area, measured in acres, included within the design site lines of a residential development.

Guest House. A detached structure accessory to a single dwelling, accommodating living/sleeping quarters, but without kitchen or cooking facilities.

H. Definitions

Habitable Space. The portion of a building that is suitable for human occupancy.

Hand Wrought. Wrought iron finish that appears hammered or shaped by hand.

Hardscape. Paving, decks, patios, and other hard, non-porous surfaces.

Height

1. **Height, Number of Stories.** The number of stories in a structure allowed above adjacent finished grade. See "Stories."
2. **Height, Overall.** The vertical distance between adjacent finished grade and the highest part of the structure directly above. See Subsection 11.030.3.A.(6) for measurement method.
3. **Height, Highest Eave/parapet.** The vertical distance between adjacent finished grade and the highest eave or parapet of the building. See Subsection 11.030.3.A.(6) for measurement method.

Height, Above Grade. See "Height" in Section 17.08.1700 (Definitions).

Height Measurement on a Sloping Design Site. This is addressed in Section 11.030 (Measurement Methods).

High Water-use or Non-drought-Tolerant Plant. A plant that will require regular irrigation for adequate appearance, growth, and disease resistance.

Historic Resource. Any resource that has been designated as historic and listed in the historic resource inventory.

Historical Structure. Any building or structure listed on or eligible for listing on the national, state, or local register of historic resources.

House. See Section 05.050 (House).

House-Scale Building. A building that is the size of a small-to-large house and detached from other buildings, typically ranging from 24 feet to as large as 80 feet overall, including wings.

I. Definitions

Identification Sign. A sign for the purpose of identifying the name of a business.

Illuminated Sign. A nonelectric sign illuminated by an exterior light source provided specifically for the purpose of sign illumination.

Impervious. The area of any surface that prevents the infiltration of water into the ground including, but not limited to, roads, parking areas, concrete, and buildings.

Improved. An area which has been paved or planted and is permanently maintained as such.

Improvement. The product of any modification to a site structure or building, not including maintenance or repairs.

Infill. The development of vacant land that was bypassed by earlier waves of development and is now largely surrounded by developed land.

Irrigation Efficiency. The measurement of the amount of water beneficially used divided by the amount of water applied. Irrigation efficiency is derived from measurements and estimates of irrigation system, characteristics, and management practices.

Irrigated Landscape Area. An entire design site less the building footprint, driveways, non-irrigated portions of parking lots, and other hardscape areas. Landscape areas encompass all portions of a development site to be improved with planting and irrigation. They include water bodies including, but not limited to, fountains, swimming pools, and ponds. Natural open spaces without irrigation systems are not included.

J. Definitions

No specialized terms beginning with the letter J are defined at this time.

K. Definitions

Kitchen. A room that is utilized for the preparation of food and contains a kitchen sink.

L. Definitions

L-Shaped (syn. Ell). A horizontal form for the main body of a building or a massing composition, also referred to as an "Ell" which is an extension at a right angle to the length of a building.

Landing. A level area at the top or bottom of a staircase or between one flight of stairs and another.

Landscaping. Flowers, shrubs, trees, or other decorative material of natural origin.

LEED™ Rating System. The most recent version of the Leadership in Energy and Environmental Design (LEED™) Commercial Green Building Rating System, or other related LEED™ rating system, approved by the U.S. Green Building Council.

Legal Nonconforming Sign. A sign which was legally constructed in compliance with laws or standards in effect at the time of construction which does not conform with Chapter 8 (Specific to Signage Types).

Lined Building. A two-part building consisting of an exterior occupiable building specifically designed to mask the interior building, which consists of a parking structure, building with few windows, or a parking lot, from a frontage.

Liner Building. An occupiable structure specifically designed to mask a parking lot or a parking structure from a frontage.

Lintel. A horizontal architectural member spanning and usually carrying the load above an opening.

Listed Resource. See "Historic Resource."

Live/Work. An integrated housing unit and working space, occupied and utilized by a single household in a structure, either single-unit dwelling or multiple-unit dwelling, that has been designed or structurally modified to accommodate joint residential occupancy and work activity, and which includes:

1. Complete kitchen space and sanitary facilities; and
2. Working space reserved for and regularly used by one or more occupants of the unit.

Living Area. The interior habitable area of a dwelling unit, including basements and attics, but not including garages or any accessory structure.

Loading Dock(s). A platform where cargo from vehicles can be loaded or unloaded.

Loading Spaces, Off-street. Permanently improved and maintained areas on the design site dedicated to loading and unloading of materials, equipment, and merchandise.

Lot. See "Design Site."

Low-Water-Use or Extra Drought-Tolerant Plant. A plant that can survive without irrigation throughout the year once established, although supplemental water may be desirable during drought periods for improved appearance and disease resistance.

M. Definitions

Main Body. The primary massing of a primary building. See Subsection 11.030.3.A.(1) for measurement method.

Main Facade. The front facade of a building.

Main Street Building. See Section 05.160 (Main Street Building).

Major. Having a greater size, scope, effect, characteristic, or quality relative to the other corresponding sizes, scopes, effects, characteristics, or qualities; or being the greater of two or more.

Maker Shopfront. See Section 06.090 (Maker Shopfront).

Massing. The overall shape or arrangement of the bulk or volume of a building and structures.

Master Sign Program. A program which establishes sign development standards and specifies an integrated sign design concept for commercial and industrial complexes.

Median. A planted or paved area which separates two roadways or divides a portion of a road into two or more lanes.

Minor. Having a lesser size, scope, effect, characteristic, or quality relative to the average size, scope, effect, characteristic, or qualities; or being the lesser of two or more.

Mixed-Use. Multiple functions within the same building or the same general area through superimposition or within the same area through adjacency.

Mobile Home. A vehicle, other than a motor vehicle, designed and equipped to contain one or more dwelling units to be used without a permanent foundation, and which is in excess of 8 feet in width and in excess of 40 feet in length.

Moderate Water-Use or Semi-Drought-Tolerant Plant. A plant that can survive throughout the year with occasional irrigation.

Monument Sign. A sign whose supporting structure is 100 percent of the sign face, length, and width, and whose supporting structure does not exceed the approved sign face area.

Multiplex Small. See Section 05.090 (Multiplex Small).

Multiplex Medium. See Section 05.130 (Multiplex Medium).

Multi-Unit Building. A residential, non-residential, or mixed-use building in which there exists three or more separate units with direct exterior access and in which there are appurtenant shared facilities. Distinguishing characteristics of a multi-tenant building or use may, but need not, include common ownership of the real property upon which the building or use is located, common wall construction, and multiple occupant use of a single structure.

N. Definitions

Neighborhood Center. A walkable environment that provides a mix of civic, institutional, and/or commercial uses.

New Construction. Structures for which the "start of construction" commenced on or after the effective date of this ODS.

Nonconforming Design Site. A design site that was legally created before the effective date of this ODS and does not comply with the minimum area, depth, width, or other applicable standards of the zone it is located.

Nonconforming Site Improvement. A site improvement (e.g., fences, landscaping, parking, walls, etc.) that conformed to the standards of the previous zoning that lawfully existed before the effective date of this ODS and does not conform to the present standards of the zone in which it is located.

Nonconforming Structure or Building. A structure or building that lawfully existed before the effective date of this ODS and does not conform to the present standards of the zone in which it is located.

Nonconforming Use. A use of a building, structure, or site, or portion thereof, or a building, structure or facility itself, which was lawfully established and maintained but, because of the application of this ODS to it, does not conform to the present standards of the zone in which it is located.

Noncommercial Signage. Any message which is determined not to be commercial (i.e., campaign signs or nonprofit signs).

Non-Street Frontage. Building facades that do not face a street or open space.

O. Definitions

Off-Street Parking. The area(s) located on a design site available for temporary storage of passenger vehicles, including a public or private parking lot where parking is the principal use of the property.

Open Space. An outdoor area dedicated for public gathering and civic activities. See Section 9.030 (General to Open Space).

Open Space Easement. See "Scenic Easement or Open Space Easement."

Open Structure. An accessory structure having a roof constructed of lattice or other roof material which allows light and air to pass through a minimum of 50 percent of the roof surface. Additionally, the sides of an open structure consist only of support posts and decorative or functional elements including, but not limited to, braces and railings such that light and air can pass through a minimum of 75 percent of each side. Open structures include but are not limited to trellises, trellis-like patio covers, and other shade structures. Play structures do not qualify as open structures, but are regulated as minor or major accessory structures.

Open Sub-Districts. See Section x.02.030 (Sub-Districts).

Oriel Window (syn. Upper Story Bay Window). A window that projects from the building facade or elevation, located on upper floors and may extend for multiple stories.

Outdoor Advertising Structure, Billboard, or Signboard. Any structure or portion thereof, situated on private premises, on which lettered, figured, or pictorial matter is displayed for advertising purposes or products not appurtenant to the use of the premises. This definition shall not include any sign used to display any official notices or bulletin boards wherein such bulletin boards are used to display announcement of meetings to be held on premises wherein such bulletin boards are located, nor shall it be held to include real estate signs advertising for sale or rent the property upon which it stands, name plates, or signs appurtenant to any use.

Outdoor Sales Display. An area where customers are encouraged to examine and/or experience merchandise in their typical configuration and/or manner of use.

Outdoor Storage Building. A building used primarily for storage of goods and materials, and uninhabitable.

Overhead Doors. Doors constructed in horizontally hinged sections that are equipped with hardware that rolls the sections into an overhead position, clear of the opening.

P. Definitions

Painted Wall Sign. See Section 8.080 (Painted Wall Sign).

Parapet. A low wall along the edge of a roof or the portion of a wall that extends above the roof line.

Parcel (syn. Lot). A portion of land separate from others and delineated or described as a single integral unit on a subdivision map or by other map approved in compliance with the Subdivision Map Act (§66410 et seq.).

Parcel Line Adjustment. A shift or rotation of an existing parcel line between four or fewer existing, adjoining parcels, where the land taken from one parcel is added to an adjoining parcel and where a greater number of parcels than originally existed are not created, as provided in Section 16.08.130 (Lot Line Adjustment).

Parcel Map. A map prepared for the purpose of dividing a legal parcel into four or fewer parcels and prepared in compliance with the provisions of this Article [x](#) and the Subdivision Map Act (§66410 et seq.) and in a manner to be recorded in the office of the County Recorder.

Parcel, Nonconforming. A legally created parcel which does not conform with current standards for area, width, frontage or other such standards for the zone in which the parcel is located because of annexation or amendments to the title.

Parking Driveway Width. The horizontal measurement of an access driveway to a parking area, measured perpendicular to the direction of travel.

Parkway. That portion of a public right-of-way located between the outermost curb-lane driving lane and the farthest edge of the right-of-way.

Passageway. A pathway unobstructed clear to the sky and extends from a street to one entrance of the accessory dwelling unit.

Passive Recreation. See "Recreation, Passive."

Path of Travel. A continuous, unobstructed way of pedestrian passage.

Patio Cover. A one story, roofed structure, not more than 12 feet in height above adjacent finished grade, used only for recreational and/or outdoor living purposes, that may be attached or detached as an accessory structure to the primary building.

Pedestrian. All people who move along sidewalks at a walking or running pace, including those in wheelchairs, mobility scooters, and strollers.

Pedestrian Shed. An area centered on a destination including, but not limited to, a civic space, civic building, or main street. Its size is limited by an average distance that may be traversed at an easy walking pace in a given amount of time from its center to its edge, about 1,500 feet. Pedestrian sheds are used for planning Walkable Urban areas.

Pedestrian Orientation. A physical structure or place with design qualities and elements that contribute to an active, inviting, and pleasant place for pedestrians that typically includes most of the following elements:

1. Building facades that are highly articulated at the street level, with interesting uses of material, color, and architectural detailing, located directly behind the sidewalk;
2. Visibility into buildings at the street level;
3. A continuous sidewalk, with a minimum of intrusions into pedestrian right-of-way;
4. Continuity of building facades along the street with few interruptions in the progression of buildings and stores;
5. Signs oriented and scaled to the pedestrian rather than the motorist; and/or
6. Pedestrian orientation may also include: design amenities related to the street level including, but not limited to, awnings, paseos, and arcades; landscaping and street furniture.

Pedestrian-Oriented Businesses. General commercial businesses that allow customers to park once and complete multiple transactions and visits on foot in a context that encourages people to walk instead of drive.

Pedestrian-Oriented Use. A land use that is intended to encourage walk-in customers and that generally does not limit the number of customers by requiring appointments or otherwise excluding the general public. A pedestrian oriented use provides spontaneous draw from sidewalk and street due to visual interest, high customer turnover, and/or social interaction.

Pediment. A triangular space that forms the gable of a low-pitched roof and that is usually filled with relief sculpture in classical architecture.

Pennant. Any lightweight flexible plastic, fabric, or other material, whether or not containing a message of any kind, suspended from a rope, wire, or string, in a series of three or more, designed to move in the wind.

Permanent Sign. A sign for which a Sign Permit is required and may be issued with no time limit.

Planning Commission. The City's Planning Commission, referred to in this ODS as the Planning Commission.

Planning Director. See "Director."

Plot Plan. A plan for an individual residential design site within an approved subdivision. At a minimum, the plot plan shows the design site property lines with metes and bounds; street address; driveways; grading; proposed locations for structures; public and private improvements (e.g., utility service laterals); retaining walls; trees; and measurements to locate these improvements within the design site.

Podium. A continuous projecting base or pedestal under a building often occupied by parking.

Podium Top. A flat, elevated and open area above a podium that can be used as common area.

Pole Sign. A sign wholly supported by a sign structure consisting of poles or posts in the ground.

Porch. A covered shelter projecting in front of the entrance of a building.

1. **Porch, Engaged.** See Section 6.050 (Porch Engaged).

2. **Porch, Projecting.** See Section 6.040 (Porch Projecting).

Portable Sign. A temporary sign which is not fastened to its supporting surface including, but not limited to, an A-frame or sandwich board.

Pre-Development Grade. The grade of a design site prior to any site improvements related to the proposed development.

Premises. An area of land with its appurtenances and buildings which because of its unity of use may be regarded as the smallest conveyable unit.

Primary Building. See "Building, Primary."

Primary Living Space. A space within the primary building that is designed as a living room, dining room, or bedroom.

Private Open Space. The area required for each unit in some building types, provided as outdoor yard areas, patios, decks, and balconies, but excluding stairs, entrance decks, and/or landings. Does not include required setbacks.

Private Street. Any street not a public street.

Projecting Sign. See Section 8.050 (Projecting Sign).

Public Assembly. A gathering of members of the public. See "Community Assembly."

Public Property. Any property publicly owned outside of the designated public right-of-way.

Public Safety Building. Buildings for public utility uses including substations, fire stations, police stations, hospitals, and similar uses.

Public Street. A street for which the right-of-way is owned by or offered for dedication to the public and accepted by the City.

Public Use. A use undertaken by a political subdivision.

Q. Definitions

No specialized terms beginning with the letter Q are defined at this time.

R. Definitions

Rake. The sloped end portion of a roof. Rakes may be close to, or extend from the building to allow for an overhang. Roof rakes can be exposed or closed.

Readerboard. A nonelectrical sign announcing events taking place on-site, the message of which is periodically changed, not including time-temperature devices.

Rear. Opposite of front.

Rear-Loaded (syn. Rear Access). Vehicular access from the rear of the design site.

Recessed Entry. An entrance to a building that is set back from the facade of the building.

Reclassification of Land. An amendment to this Article, which changes the classification of any property from one zone to another zone provided for in compliance with this Article.

Recreation, Active. Recreational pursuits usually performed with others and often requiring equipment which required physical alteration to the area in which they are performed. Such areas are intensively used, and include but are not limited to playgrounds; sport courts; baseball/softball and other field sports; and swimming pools.

Recreational Area. Areas of active play or recreation including, but not limited to, sports fields, school yards, picnic grounds, or other areas with intense foot traffic.

Recreation, Passive. Recreational pursuits involving existing natural resources which can be carried out with little alteration or disruption to the area in which they are performed. This includes, but is not limited to such activities as walking; hiking; bicycling; bird and animal watching; and picnicking.

Recreation, Commercial. Recreation facilities operated as a business and open to the general public for a fee.

Recreation, Private, Noncommercial. Recreation facilities operated by a nonprofit organization and open only to bona fide members of such nonprofit organization.

Relocation. The act or process of moving a structure or object from one property to another property or to a different location on the same property.

Renovation

1. A structural change to the foundation, roof, floor, or exterior of load-bearing walls of a facility, or the extension of an existing facility to increase its floor area.
2. Alteration of an existing facility including, but not limited to, significantly changing its function, even if such renovation does not include any structural change to the facility.
3. Remodeling of the building interior or exterior.

Rental Shops - Consumer Goods. Consumer-oriented rental shops including party furnishings; household tools and appliances; consumer-scale garden equipment; auto-related equipment; etc. Includes vending machine service. Does not include construction equipment rental.

Residential. Premises used primarily for human habitation.

Residential Development. Any development that consists entirely of dwellings.

Review Authority. The individual or official body (the Planning Department Director, Planning Commission, or Jurisdiction Council) identified by this ODS as having the responsibility and authority to review, and approve or deny the permit applications described in Chapter 10 (Administration).

Right-of-Way (ROW). Land dedicated to transportation purposes and/or use by the general public.

Rowhouse. See Section 5.080 (Neighborhood Townhouse) and Section 5.130 (Core Townhouse).

Runoff. Water which is not absorbed by the soil to which it is applied. Runoff usually occurs when water is applied at too great a precipitation rate, when water is applied to saturated soils, or when water is applied to a steep slope.

S. Definitions

Satellite Dish Antenna. Parabolic or spherical antenna whose purpose is to receive and/or transmit radio communication signals to and/or from satellites.

Scenic Easement or Open Space Easement. An easement granted to the public whereby the owner relinquishes or limits the right to construct improvements on the land.

Second Unit. See "Dwelling, Second Unit."

Semi-Public Use. A use owned or operated by a non-profit organization, private institution, or foundation.

Semi-Public Utility Building. A building owned or operated by a non-profit organization, private institution, or foundation, and used to provide utility services to its members or those persons it serves.

Service Entries. Building access for service providers.

Service Facilities. On-site facilities that support grounds maintenance, landscaping, and minor repair service relative to a primary use.

Setback. The distance by which a structure, parking area, or other development feature is separated from a design site line, other structure, or development feature

1. **Setback, Front.** An area extending across the full width of the design site between the front design site line and the primary structure.
2. **Setback, Rear.** An area extending the full width of the design site between a rear design site line and the primary structure.
3. **Setback, Side.** An area between a side design site line and the primary structure extending between the front and rear setback.

Setback, Building. The mandatory clear distance between a design site line and a building.

Setback, Parking. The mandatory clear distance between a design site line and parking.

Shared Parking. Any parking spaces assigned to more than one user, where different persons utilizing the spaces are unlikely to need the spaces at the same time of day.

Shopfront. See Section 6.100 (Shopfront).

Shopfront Base. A very low wall, that does not include glass, between the display window(s) of a shopfront and the adjacent sidewalk.

Sidewalk. A paved area along a street intended exclusively for pedestrian use and often installed between a street and design site frontages.

Sidewalk Sign. See Section 8.100 (Sidewalk Sign).

Sign. A structure, device, figure, display, message placard, or other contrivance, or any part thereof, situated outdoors or indoors, which is designed, constructed, intended, or used to advertise, or to provide information in the nature of advertising, to direct or attract attention to an object, person, institution, business, product, service, event, or location by any means, including words, letters, figures, designs, symbols, fixtures, colors, illumination, or projected images. See Chapter 8 (Specific to Signage Types).

Sign Area. The total area of any portion of a structure to which any message is affixed.

Sign Copy. The allowed area of any words, letters, numbers, designs, figures or other symbolic presentation incorporated into a sign with the purpose of attracting attention to the subject matter.

Sign Face. The portion of a sign that is used for displaying sign copy, together with any frame, color, panel, ornamental molding, or condition which forms an integral part of the sign copy and which is used to differentiate such sign copy from any wall or background against which it may be placed. Those portions of the supports, uprights, or base of a sign that do not function as a sign shall not be considered as part of a sign face.

Single-Loaded, Building. A building containing dwellings and/or commercial units without common hallways for access to the dwellings and/or units.

Site identification sign. A sign, other than a readerboard, which serves to inform only of the name, address and lawful uses of the premises upon which the sign is located (and which may include a trademark or symbol of a business).

Site Plan. A base sheet that includes the basic information that will appear on all plans including, but not limited to, natural features, roads, buildings, or other structures to remain on-site.

Special Architectural Elements. Church spires; belfried cupolas and domes; monuments; corner or entry towers on residential units; and other similar architectural elements.

Specific Plan. See California Government Code §65450-65457.

Stake Sign. A sign constructed of paper or plastic mounted on a wood or metal stick.

Stealth Design. The effect of integrating an element including, but not limited to, a cellular antenna into a building that results in the element not being visible from adjacent public sidewalks and open space.

Street, Front. Street located along the front design site line of a parcel.

Street, Side. Street located along a design site line of a parcel that is not along the front design site line.

Stoop. See Section 6.070 (Stoop).

Storefront. The majority portion of a shopfront frontage that consists of the display window and/or entrance and its components, including windows, doors, transoms, and sill pane.

Story. The portion of a building included between the surface of any floor and the surface of the next floor above it, or if there is no floor above, the space between the floor and the ceiling above. If the finished floor level directly above a basement or cellar is more than six feet above grade for more than 50 percent of the total perimeter, such basement or cellar shall be considered a story.

1. **Story, First.** The lowest story or the ground story of any building, the floor of which is not more than 12 inches below the average contact ground level at the exterior walls of the building.
2. **Story, Half (syn. Attic Story).** A conditioned space that rests primarily underneath the slope of the roof, usually having dormer windows. The half story is identified by the ".5" in the description of maximum height (e.g., 2.5). A half-story is considered a story when its top wall plates, on at least two opposite exterior walls, are four feet or more above the floor of such story.
3. **Story, Mezzanine.** A story which covers one-third or less of the area of the story directly underneath it. A mezzanine story shall be deemed a full story when it covers more than one-third of the area of the story directly underneath said mezzanine story.

Street. A public or permanent private thoroughfare which affords a primary means of access to design site(s).

1. **Street, Front.** Street located along the front design site line.
2. **Street, Side.** Street located along a design site line that is not the front design site line

Street Frontage. The lineal length of that portion of a design site abutting a street.

Street Frontage, Principal. The length of the property line of any one premise parallel to and along the public right-of-way which it borders and which is identified by an officially assigned street address.

Street Tree. A tree planted in open spaces, parkways, sidewalk areas, easements, streets, and rights-of-way.

T. Definitions

Tandem Parking. A parking space deep enough to allow two cars to park, one behind the other.

Terrace. See Section 6.110 (Terrace).

Temporary Sign. A sign intended to be displayed for a limited period of time only.

Thoroughfares. A way for use by vehicular, pedestrian, and bicycle traffic that provides access to design sites and open spaces, and that incorporates vehicular lanes and public frontages.

Townhouse, Neighborhood and Core. See Section 5.080 (Neighborhood Townhouse) and Section 5.130 (Core Townhouse).

Transect. A cross-section of the environment showing a range of different habitats. The Natural-to-Urban Transect of the human environment is divided into multiple transect zones that describe the physical form and character of a place according to the intensity of its land use and urbanism. See Table P-1E-B (Summary Table of Transects for Natural, Rural, and Walkable Contexts in Sebastopol).

Transect Zone. See "Form-Based District."

Transit Station. A design site or structure used for the purpose of parking, loading, and unloading freight and passengers from train or bus transportation. May include parking facilities and other commercial amenities to service transit passengers.

Transit Stop. A location where buses stop to load and unload passengers. A transit stop may or may not include a shelter or a pullout.

Transom. Refers to a window; a window above a door or other window built on and commonly hinged to a transom

Tripartite. A method of visually organizing a facade of the building by dividing it up into three sections: the base, middle, and top.

Turf. A surface layer of earth containing mowed grass with its roots. Annual bluegrass, Kentucky bluegrass, perennial ryegrass, red fescue, and tall fescue are cool-season grasses. Bermudagrass, kikuyugrass, seashore paspalum, St. Augustinegrass, zoysiagrass, and buffalo grass are warm-season grasses.

U. Definitions

Understory. The smaller trees and shrubs below the canopy of large trees.

Unit. See "Dwelling Unit."

Upper Floor. A floor in a building containing habitable space that is located above the ground floor.

Usable Open Space. Common or private open space, excluding the following:

1. Required front setbacks;
2. Areas devoted to parking, driveways, and maneuvering areas;
3. Open space at grade less than 10 feet in its minimum dimension; and
4. Patios, balconies, or decks less than five feet in their minimum dimension.

Use. The purpose for which land, premises, or structure thereon is designed, arranged, or intended, or for which it is or may be occupied or used.

Use, Accessory. A subordinate use of a building, structure, or design site that is customarily incidental to a principal use located on the same parcel.

Use, Principal. The main or primary use or uses conducted on a design site or located within a building or within a portion of a building which is separated structurally from other uses within the same building, not to include an accessory use as defined herein or a subordinate department of a main or primary use.

Use, Temporary. The use of land or premises or a building thereon for a limited period of time which does not change the character of the site, premises, or uses therein.

V. Definitions

Visitability. A basic level of accessibility that enables persons with disabilities to visit others in their dwellings by providing at least one accessible means of egress/ingress for each residential unit.

W. Definitions

Walkable Neighborhood Center. A Walkable Urban environment that provides a concentrated mix of civic, institutional, and/or commercial uses.

Walkable Neighborhood Plan (WNP). A development plan for creating Walkable Urban environments with a mix of housing, civic, retail, and service choices within a compact, walkable, and transit-ready environment. See Section 9.020 (Walkable Neighborhood Plan).

Walkable/Walkability. The condition when an area is highly interconnected to other areas and appeals to pedestrians for recreational walking or for walking to work, transit, errands, shopping, or restaurants.

Walkway. A paved way located on one or more design sites, used for pedestrian traffic, and used exclusively by the design site owner(s), their guests, and invitees.

Wall Plane. A vertical surface defined by the facades of buildings.

Wall Sign. See Section 8.070 (Wall Sign).

Wall Mural Sign. See "Painted Wall Sign."

Water Table, Architectural Feature. A horizontal projecting string-course of masonry, molding, or a ledge placed so as to divert rainwater from a building.

Width-to-Height Ratio. The ratio of the horizontal size of a space measured perpendicularly to the vertical height of a building. See Subsection 11.030.3.A.(5) for measurement method.

Window Sign. See Section 8.090 (Window Sign).

Wing. A structure of at least five feet in depth physically attached to, and secondary to, the main body of a primary building. See Subsection 11.030.3.A.(2) for measurement method.

X. Definitions

No specialized terms beginning with the letter Y are defined at this time.

Y. Definitions

Yard. See "Setback."

Yard/Porch Sign. See Section 8.040 (Yard/Porch Sign).

Z. Definitions

Zero Design Site Line. A building or structure that is placed on the property line.

Zone Map. The zoning map(s) of the City of Sebastopol, California, together with all amendments.

Zoning Administrator. The duly designated and appointed zoning administrator of the City.

Zoning Code. The Zoning Code of the City of Sebastopol specified in Title 17.

11.030 Measurement Methods

1. Sloped and Steeply Sloped Design Sites

- A. **Applicability.** The standards of Section 4.050 (Slope Standards) apply to sloped and steeply sloped design sites. Slope is measured by taking the vertical distance, or "rise", over the horizontal distance, or "run." The resulting fraction, or percentage, is the "slope" of the land. Sloped and steeply sloped design sites are those areas of land that exhibit the slopes of at least six percent.
- B. **Methodology.** The following methodology shall be used to identify steep slopes protected in compliance with this Chapter. An example of the methodology is shown in Figure 1 (Example for Defining Sloped and Steeply Sloped Design Sites).
- (1) **Steep Slope Determination.** To qualify as a steep slope, the slope shall be at least six percent with a 10-foot vertical drop over a 100-foot horizontal distance parallel to at least one common contour line. The horizontal measurement shall cross property lines to establish if a steep slope may exist on a design site (i.e., the 100-foot minimum width calculation shall cross a property line if necessary to achieve this minimum width).

Figure 11.030.1: Example for Defining Sloped and Steeply Sloped Design Sites

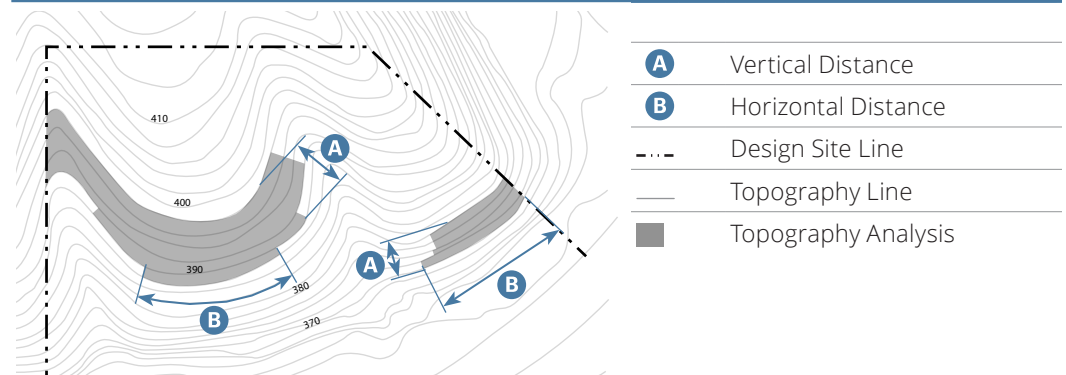

- (2) **Area Calculation.** Step slope areas are calculated based on the square feet of qualifying steep slope on the design site as determined in Subsection 1 above. There is no minimum square footage for each slope area.
- First, calculate the square footage of slopes 30 percent and greater. Determine the square footage of each area as well as the sum of these areas for the total site.
 - Second, calculate the square footage of slopes between 29 and 25 percent. Determine the square footage of each area as well as the sum of these areas for the total site.
 - Third, calculate the square footage of slopes between 24 and 20 percent. Determine the square footage of each area as well as the sum of these areas for the total site.
 - Fourth, calculate the square footage of slopes between 15 percent and 19 percent. Determine the square footage of each area as well as the sum of these areas for the total site.
 - Fifth, calculate the square footage of slopes between 10 and 14 percent. Determine the square footage of each area as well as the sum of these areas for the total site.
 - Last, calculate the square footage of slopes between 6 and 9 percent. Determine the square footage of each area as well as the sum of these areas for the total site.

- (3) **Steep Slope Resource Area.** Based on the area calculations in Subsection 2, above, Table 04.050.A (Amount of Sloped Areas Allowed to be Developed) identifies the percentage of sloped area that is developable. Figures 2 and 3 illustrate examples of the calculated slopes and the corresponding percentage allowed for development.

Figure 11.030.2: Example for a Sloped Development Site (<1 acre)

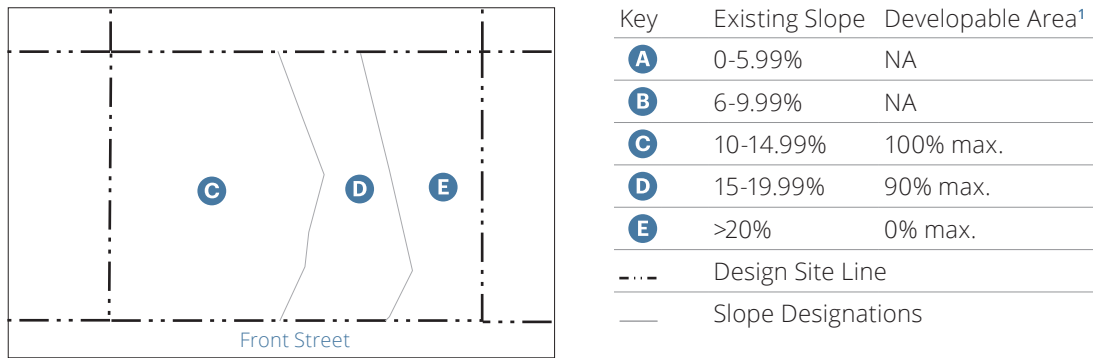
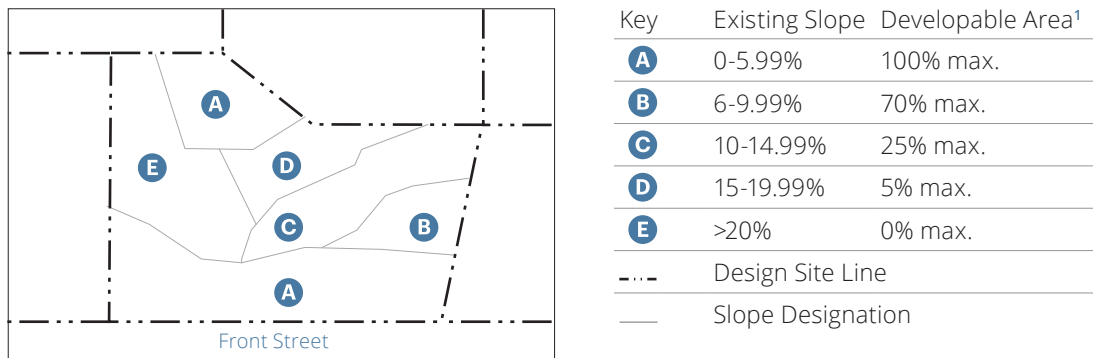

Figure 11.030.3: Example for a Sloped Development Site (>1 acre)



¹ In compliance with the setbacks of the district, required on-site open space, this Section, and the maximum building footprint standards in Chapter 5 (Building Type Standards).

- (4) **Sloping Design Site Height.** Design sites with slopes of at least six percent shall measure the maximum height of structures as set forth in the district and measured vertically from ground level at the front setback line, or if no setback is required, at the center of the design site.
- C. **Average Slope.** The result of dividing the length of a slope by the difference in elevation at the top and bottom of the slope.
- (1) **Design Sites with Even Slope.** Average slope for design sites with relatively even slope across the site and small design sites is determined by using the following formula:
- $S = ((T - B) \div \text{run}) \times 100$
 - $S = \text{average slope}$
 - $T = \text{elevation at top of slope}$
 - $B = \text{elevation at bottom of slope}$
 - $\text{Run} = \text{horizontal distance between the top and bottom elevations}$

- (2) **Design Sites with Uneven Slope.** Average slope of design sites with an uneven slope across the site before grading is determined by using the following formula:

(a) $S = (1.0029 \times I \times L) \div A$

(b) S = average slope

(c) I = contour interval in feet

(d) L = summation of length of the contour lines in scale feet

(e) A = area of the design site in acres

2. **Facade Zone Defined by Primary Building/Frontage**

- A. **Applicability.** The facade zone standards apply to new primary buildings and their additions along the front and secondary front yard of a design site.
- B. **Methodology.** The required amount is expressed in the district standards as a percentage. The percentage is calculated as follows through an example for the front facade zone. The same approach is to be applied to the secondary front yard, using the minimum front and rear building setbacks.
- (1) Identify the width of design site (e.g., 50 feet) and apply required side building setbacks (e.g., 5 feet and 5 feet).
 - (2) Subtract the horizontal length between each side setback and the adjacent side design site line from the total width of the design site. The result is the net buildable width of the design site (e.g., 40 feet).
 - (3) Multiply the required minimum percentage in the district standards (e.g., 50 percent) by the net buildable width of the design site (e.g., 50 feet).
 - (4) The result is the minimum length, in feet, of building facade and frontage type(s) that is required in or abutting the facade zone (e.g., 20 feet).
 - (5) See Figure 4 (Applying the Required Amount to the Facade Zone) for examples that are consistent with the intent of this standard.

Figure 11.030.5: Determining the Required Amount Subject to the Facade Zone

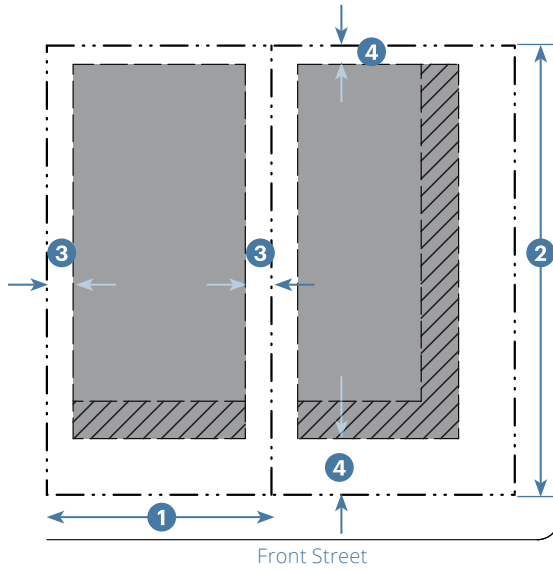

Example Calculation

50'	Design Site Width
- 5'	Side Setback
- 5'	Side Setback
= 40'	Net Buildable Width
40'	Net Buildable Width
x Zone Standard (e.g., 50%)	
= 20'	Required In or Abutting the Facade Zone

- 1 Width of Design Site
- 2 Depth of Design Site
- 3 Setback to be Subtracted from Design Site Width
- 4 Setback to be Subtracted from Design Site Depth

Figure 11.030.4: Applying the Required Amount to the Facade Zone

A. Abutting Facade Only

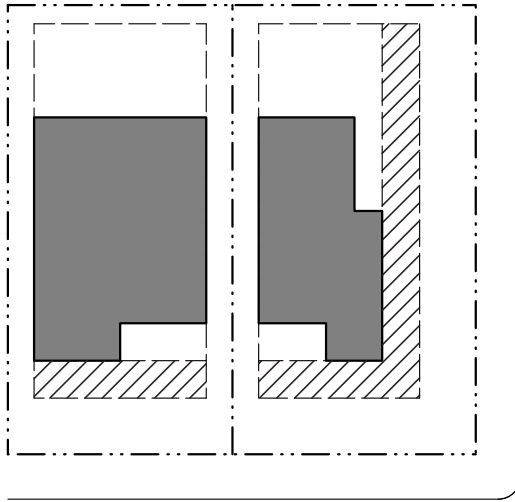

B. Within Facade Zone Only

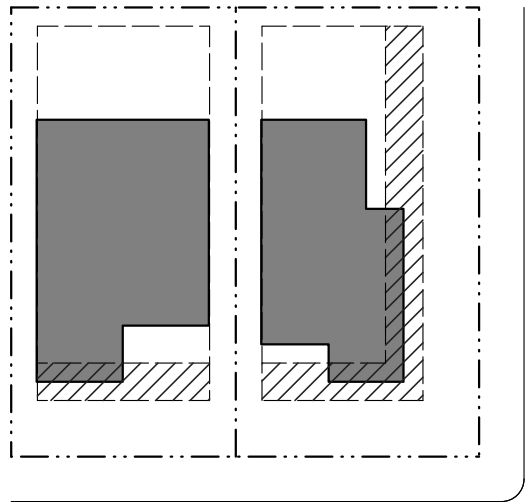

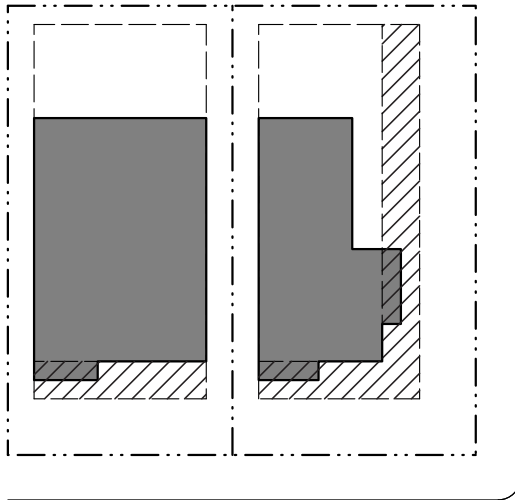

C. Abutting and Within Facade Zone

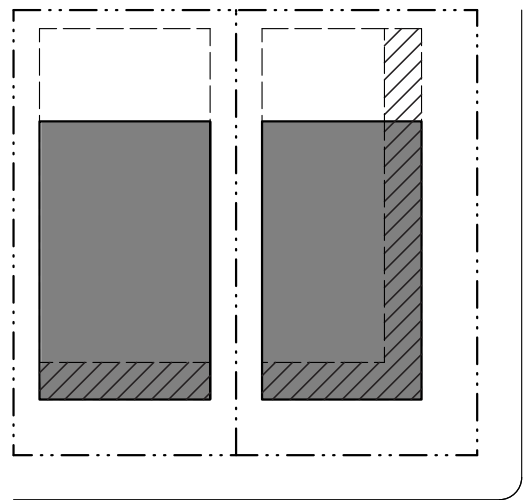

D. For Districts with 0' minimum Setbacks



		Front Street	Secondary Front Yard
	Facade Zone	50% min. ¹	50% min. ¹
	Buildable Area for Building and Frontage Type(s)	A	B

¹This is an example. See Subsection 5 of the district for the standard.

3. **Measuring Building Types**

A. **Methodology.** Measurement of width and depth.

- (1) **Main Body.** The width and depth of the main body shall be measured as follows:
 - (a) The width shall be parallel to the front.
 - (b) The depth shall be perpendicular to the front.

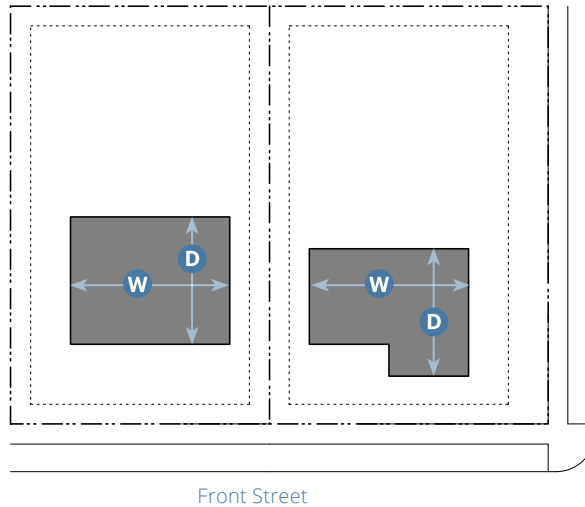

**Figure 11.030.6:
Main Body**

- W** Width
- D** Depth

- (2) **Wings and Ancillary Structures.** The width and depth of wings and ancillary structures, shall be measured as follows:
 - (a) The width shall be the greater of the two dimensions of the footprint.
 - (b) The depth shall be the lesser of the two dimensions of the footprint.

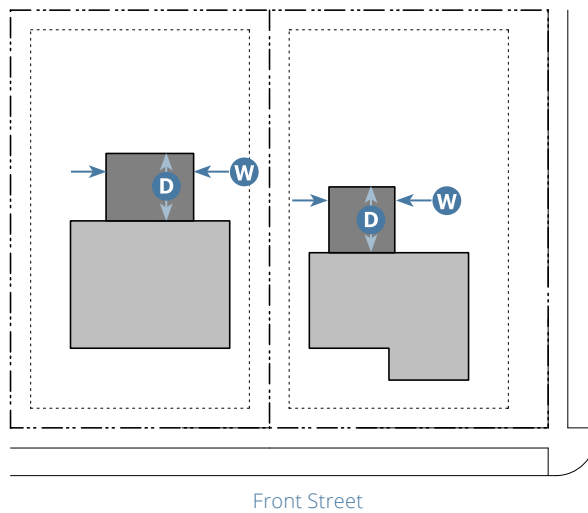

**Figure 11.030.7:
Wings and Ancillary Structures**

- W** Width
- D** Depth

- (3) **Open Space(s).** The width and depth of open spaces shall be measured as follows:
- (a) The width shall be parallel to the front
 - (b) The depth shall be perpendicular to the front.

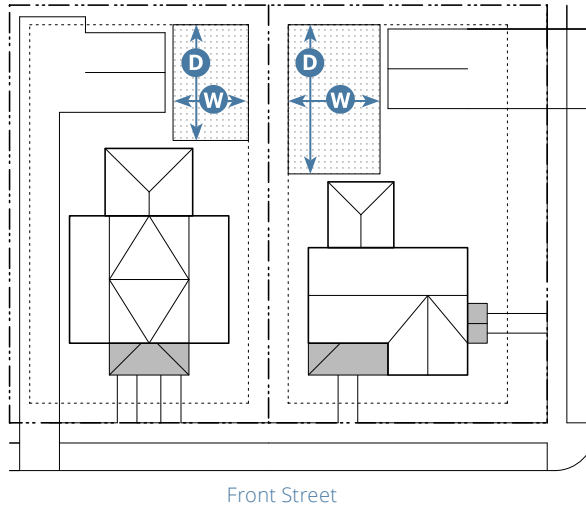

**Figure 11.030.8:
Open Space(s)**

- W** Width
- D** Depth

- (4) **Courtyard(s).** The width and depth of courtyards shall be measured as follows:
- (a) The width shall be parallel to the front; unless the courtyard is a secondary courtyard accessed directly from a secondary front yard.
 - (b) If a secondary courtyard is accessed directly from the secondary front yard, the width shall be parallel to the secondary front yard.
 - (c) The depth shall be perpendicular to the width.

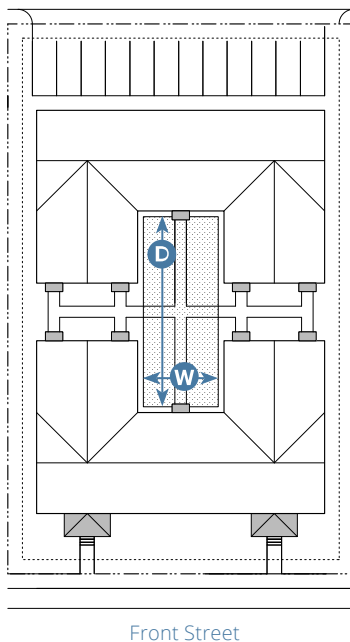

**Figure 11.030.9:
Courtyard(s)**

- W** Width
- D** Depth

- (5) **Width-to-Height Ratio.** Measurement of width-to-height ratio and depth-to-height ratio of forecourts.
- The width and depth of forecourts shall be measured per Figure 10 (Width-to-Height Ratio).
 - The height of forecourts shall be a measurement of the vertical plane of the building that defines the forecourt.

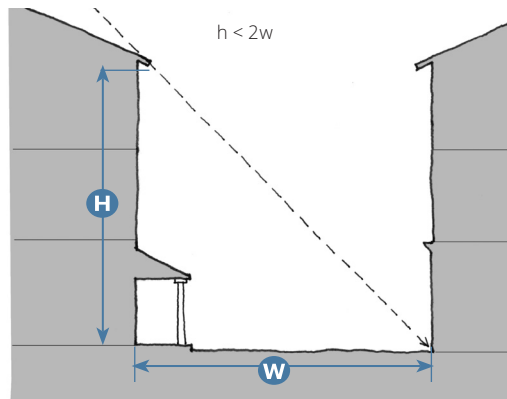

Figure 11.030.10:
Width-to-Height Ratio

-
- W Width
-
- H Height

(6) **Highest Eave/Top of Parapet.**

- (a) **Height, Overall.** The vertical distance between adjacent finished grade and the highest part of the structure directly above. See Figures 11 and 13.
- (b) **Height, Top of Parapet.** The vertical distance between adjacent finished grade and the top of the parapet of the primary building. See Figure 11.
- (c) **Height, Highest Eave.** The vertical distance between adjacent finished grade and the highest eave of the primary building. See Figure 13.
- (d) **Highest Eave Measurement.** The measurement is to bottom of the eave assembly.
- (e) **Eave.** The edge of the roof that overhangs the face of the adjoining wall. The bottom of the eave can range from exposed rafters to a finished horizontal surface.

Figure 11.030.11: Top of Parapet and Flat Roof

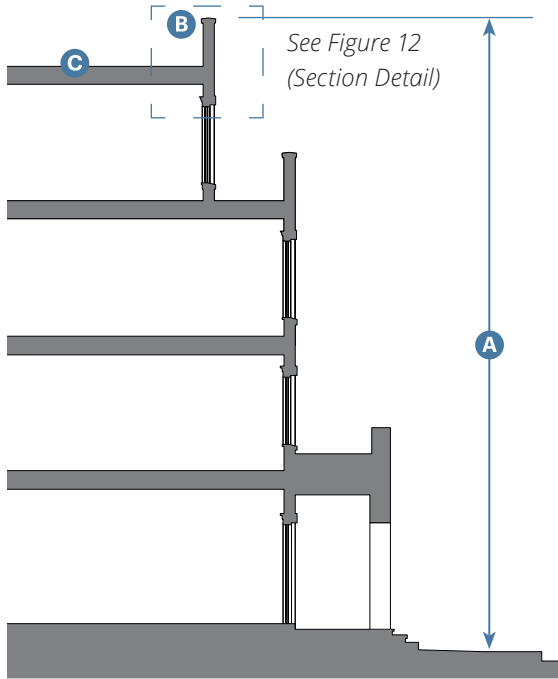
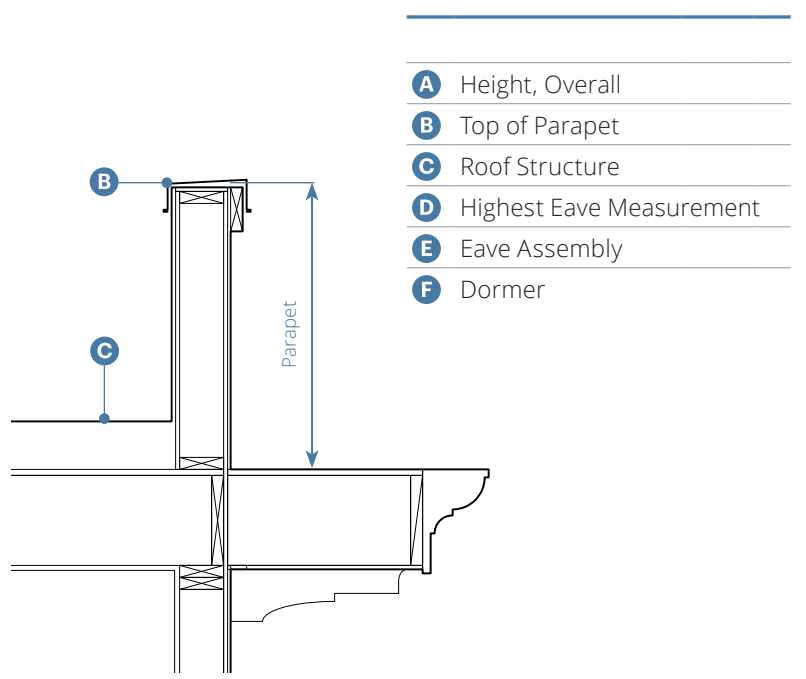

Figure 11.030.12: Section Detail of Top of Parapet and Flat Roof



- A** Height, Overall
- B** Top of Parapet
- C** Roof Structure
- D** Highest Eave Measurement
- E** Eave Assembly
- F** Dormer

Figure 11.030.13: Highest Eave for Pitched Roof

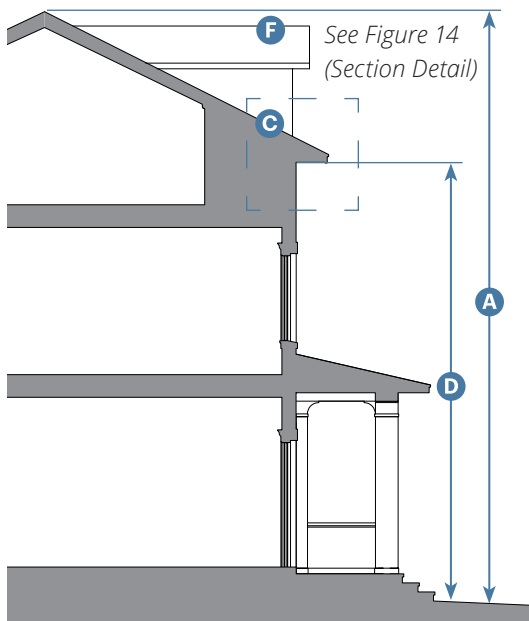
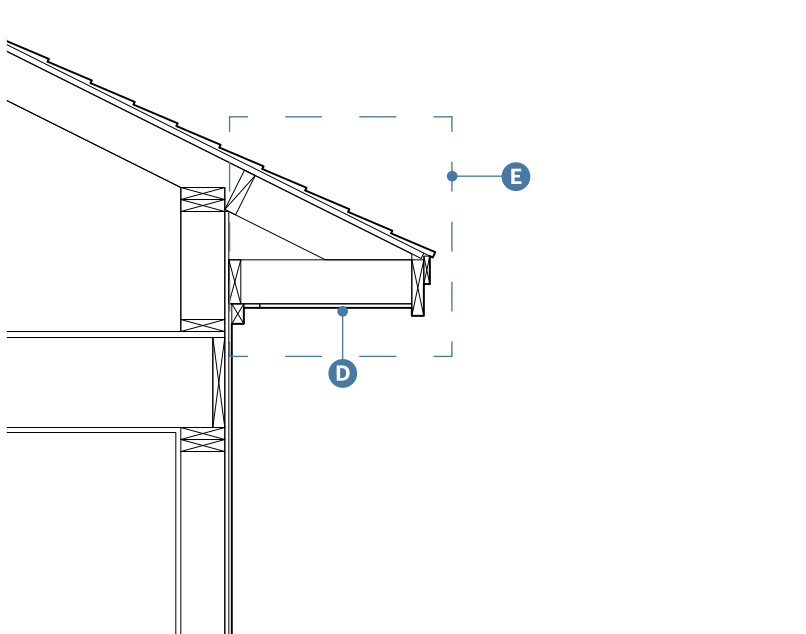

Figure 11.030.14: Section Detail of Highest Eave for Pitched Roof



Missed Edit(s):
 Updated text to clarify re bays as follows:
 1. Edited Applicability text
 2. Edited text in 4.C and 4.C.(2)
 3. In Adoption Hearing Draft, add new Add new C (3): "If no required range of bays is specified by the massing type, any number of bays may be selected in compliance with Subsection 7.050.05(Bay Composition)" and update subsection numbering.
 4. Updated diagram labels, middle diagram, and key

4. **Measuring Bays.**

- A. **Applicability.** All buildings, with or without wings must have defined bays, ~~numbering~~ as specified in ~~this Subsection~~ Subsection 7.050.5 (Bay Composition).
- B. **Bay Measurement.**
 - (1) Boundaries of each bay shall extend vertically from the lower boundary of the main body or wing to the upper boundary of the same division and shall not intersect any opening.
 - (2) Boundary is considered to lie at the midpoint between successive openings unless marked by an expression of vertical structure on the façade. Bay width shall be measured horizontally from one boundary to the next.
- C. **Building Types and Bays.** ~~Bays shall be placed~~ For the massing types identified in Section 5.160 (Massing Compositions), bays shall be distributed according to the following methodology. An example of the methodology is shown in Figure 15 (Example of Massing Type and Bays).
 - (1) Select main body massing type from Subsection 3 (Building Size and Massing) of the selected building type (e.g., Sloped Roof L). See Figure 11.030.15A (Select Main Body Massing Composition).
 - (2) ~~Within~~ For each volume/facade of the main body massing, identify and apply a number of bays within the allowed range. See Figure 11.030.15B (Identify the Required Number or Range of Bays).
 - (3) See Figure 11.030.15C (Examples of Bay Compositions in Compliance with Required Massing Proportions) for examples that are consistent with the intent of this standard.

Figure 11.030.15: Example of Massing Type and Bays

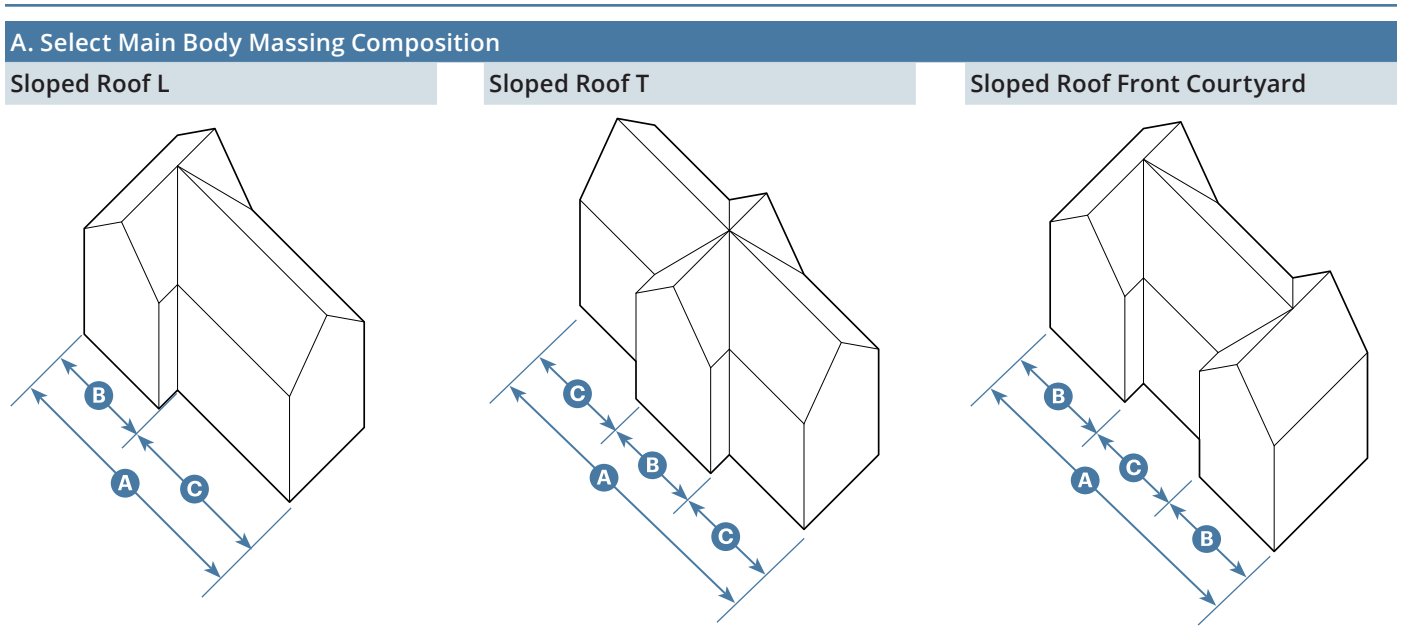

Key

A	Required Massing Proportions and Number of Bays
A	Main Body width Maximum dimension is regulated by Subsection 3 of the building type.
B	Projecting Volume(s) Minimum and maximum number of bays are regulated by the massing type.
C	Recessed Facade(s) Minimum and maximum number of bays are regulated by the massing type.

Missed Edit:

Update center diagram on top row in Adoption Hearing Draft

B. Identify the Allowed Range of Bays by Volume/Facade for Selected Massing Type

Sloped Roof L: 1-5 Bays + 1-7 Bays

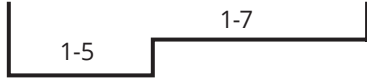

Sloped Roof Forecourt: 1-7 Bays + 1-5 Bays + 1-7 Bays

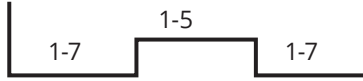

Sloped Roof Front Courtyard: 1-5 Bays + 1-7 Bays + 1-5 Bays

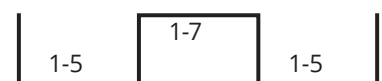

C. Examples of Bay Compositions in Compliance with Required Massing Proportions

5-Bay Composition (2 + 3)

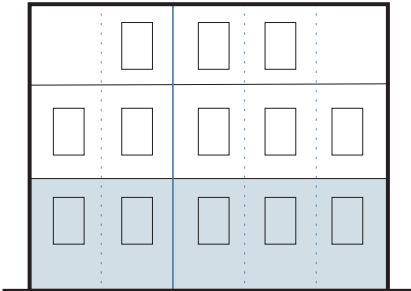

3-Bay Composition (1 + 1 + 1)

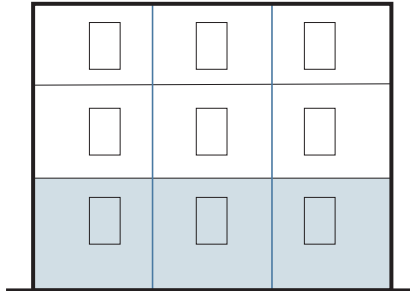

6-Bay Composition (2 + 2 + 2)

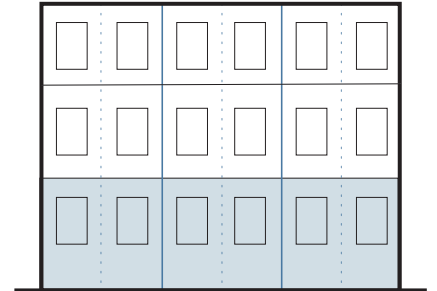

3-Bay Composition (1 + 2)

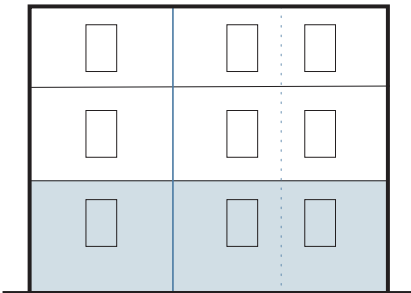

6-Bay Composition (2 + 2 + 2)

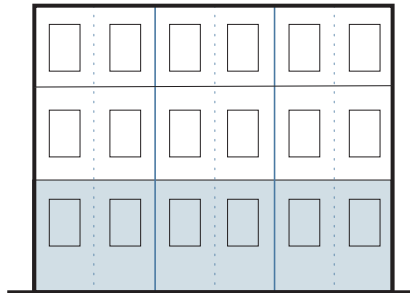

3-Bay Composition (1 + 1 + 1)

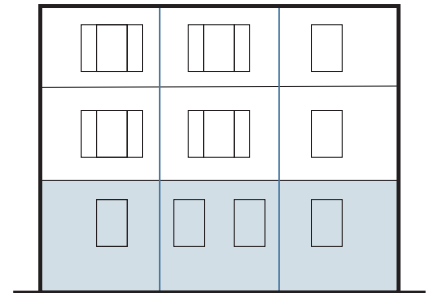

Key

■ Ground Floor

This page intentionally left blank