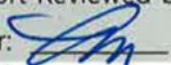

Agenda Report Reviewed by:
City Manager: 

CITY OF SEBASTOPOL
CITY COUNCIL
AGENDA ITEM

Meeting Date: April 4, 2023
To: Honorable Mayor and City Councilmembers
From: Mario Landeros, Interim City Engineer
Subject: AmeriCorps Trail Extension Contract No. 2022-03
Recommendation: Approve the Plans and Specifications and Authorize to Bid AmeriCorps Trail Extension Contract No. 2022-03
Funding: Currently Budgeted: Yes No N/A

Account Code/Costs authorized in City Approved Budget (if applicable) AK (verified by Administrative Services Department) 202-Measure M Parks, 212-Park Improve Fund (Laguna), 212-Park Improvement (Sonoma Co.), 212-Park Improvement Fund (See "Fiscal Impact" section for details.)

INTRODUCTION/PURPOSE:

The item is to request Council approve the Plans and Specifications and authorize to bid AmeriCorps Trail Extension Contract No. 2022-03 ("Project").

BACKGROUND:

The Project, AmeriCorps Trail Extension, is CIP Project # 0411-73.00 in the adopted Fiscal Year 2022-23 Capital Improvement Program (CIP). The Project proposes to construct a trail extension, a pedestrian bridge at Zimpher Creek and make improvements to the current trail segments.

The Project, which is a portion of the Laguna de Santa Rosa Trail system, is located east of Morris Street and on the west side of the Laguna Preserve, extending over City property in the area between Sebastopol Avenue near the west end of the SR12 bridge and Laguna Park, about 1,850 feet (see Attachment 1 – Location Map). The unpaved trail in this area has been in existence as a seasonally used, narrow dirt pathway or social trail winding through an open willow forest, since at least the early 1990's. It was modestly improved by AmeriCorps service members and volunteers in 2007 when they completed vegetation clearing and widening of portions of the existing trail. Despite these early improvements, over the years since 2007 portions of the existing trail have fallen into disrepair and at times becoming overgrown by vegetation, and periodically subject over-bank flows of the Laguna during heavy winter storms.

DISCUSSION:

The proposed Project consists of the main trail, which generally extends north-south from State Route (SR) 12 to the Laguna Youth Park and the Sebastopol Community Center, and two sub-trails that connect the main north-south trail to points on Morris Street.

The main north-south trail begins at the existing concrete sidewalk on north side of SR 12 just west of the Laguna Bridge to the southerly edges of Laguna Youth Park and the Sebastopol Community Center. Earthwork proposed in this trail section includes minor ground clearing, grading to cut high points along the alignment and fill in low areas, to provide a consistent six-foot wide clear path width. Maximum cut height is 3 feet and maximum fill depth is less than 2 feet. Most of the work involves cuts and fills of less than 1.5 feet. The work also includes scarifying and re-compacting the top 6 inches of native ground and placing 4" compacted imported rock aggregate to form a stable walking surface. Work in this segment also includes the installation of a light weight (6 ft. wide x 42 ft. long),

pre-engineered aluminum foot bridge over Zimpher Creek, a small tributary of the Laguna. The bridge will be installed in pieces or units for “bolt together” field assembly. It will be founded on concrete footings cast into 2’ excavations. The bridge will be set onto anchor bolts cast into the concrete to hold and secure it in place. At its southerly end point the trail will connect to the existing concrete sidewalk on the north side of SR 12. The trail slopes will vary and generally be at grades of less than 2% except at the northerly approach the bridge (3.2%) and at the connection to existing SR 12 sidewalk (4%.) The work also includes the constructing a 6-foot wide “puncheon” wood foot bridge spanning 155 feet over low-lying areas along the trail alignment that ponds water following rain events. This ponding area is the result of years of over-bank flows of the Laguna channel. The wood structure will be founded on a series of concrete pier blocks to elevate the trail above typical ponding levels for nearly year-round use, while minimizing the grading work necessary in the area.

The two sub-trails that connect the main trail to Morris Street are located: 1) over an existing foot path along the north fence of the former Concrete Plant site (sub-trail #1); and 2) along the City’s wastewater lift station entrance driveway (sub-trail #2) that begins at the end of a paved driveway. Similar to earthwork in the main trail, proposed earthwork on these sub-trail sections includes minor ground clearing, minimal grading to cut high points along the alignment and minimal fill in low areas, to provide a consistent six-foot wide clear path width. The work also includes scarifying and re-compacting the top 6 inches of native ground and placing 4” compacted imported rock aggregate to form a stable walking surface. The trail slopes will vary and generally be at grades of less than 2%.

The plans and specifications (Attachment 2) prepared by KASL Engineering have been reviewed by the Public Works Department and approved by the City Engineer.

After Council’s authorization to bid the plans and specifications a Bid Notice will be advertised in accordance with the Public Contract Code for solicitation of bids for a public project. Soon after advertising the bid notice staff will receive and review the bids for conformance with the bid procedures and will report to the City Council at a later date the bid results and a recommendation for bid award.

The anticipated Project schedule is bid award in June 2023 and start construction in July 2023. The estimated duration of construction is approximately four (4) months with completion by late fall 2023. The Engineer’s Estimate for the construction, including a contingency amount for unforeseen conditions, is \$290,000.

GOALS:

This action supports the following City Council Goals and General Plan Actions:

- Circulation CIR 2: Maintain and Expand a Safe and Efficient Pedestrian, Bicycle, and Transit Network that Connects Neighborhoods with Key Destinations to Encourage Travel by Non-Automobile Modes while also Improving Public Health

ENVIRONMENTAL REVIEW

The proposed project, AmeriCorps Trail Extension, involves the repair and maintenance of existing public facilities (pedestrian trails), replacement or reconstruction of existing structures and facilities where the new structure will be located on the same site as the structure replaced, minor alterations to land, and small habitat restoration with negligible or no expansion of use and therefore is exempt from the provisions of the California Environmental Quality Act (CEQA) pursuant to CEQA Guidelines 15301(c), 15302, 15303, 15304(a), and 15333. A Notice of Exemption prepared for the Project has been approved by the Planning Director and will be filed with the County Clerk prior to bidding.

PUBLIC COMMENT:

As of the writing of this staff report, the City has not received any public comment. However, if staff receives public comment from interested parties following the publication and distribution of this staff report, such comments will be provided to the City Council as supplemental materials before or at the meeting. In addition, public comments may be offered during the public comment portion of the agenda item.

PUBLIC NOTICE:

This item was noticed in accordance with the Ralph M. Brown Act and was available for public viewing and review at least 72 hours prior to schedule meeting date.

FISCAL IMPACT:

The adopted Fiscal Year 2022-23 CIP budget includes an amount of \$300,000 for the construction and inspection/construction management in Parks Capital Fund and Parks Grant Funds. See Table 1 for details.

Table 1 Project Funding Breakdown for Construction Costs

Description	202-Measure M Parks	212-Park Improve Fund (Laguna)	212-Park Improvement (Sonoma Co.)	212-Park Improvement Fund
AmeriCorps Trail Extension Project CIP # 0411-73.00	\$61,103	\$28,000	\$126,943	\$83,954
Subtotal per Fund	\$61,103	\$28,000	\$126,943	\$83,954
Total-All Funds	\$300,000			

RECOMMENDATION:

Staff recommends the Sebastopol City Council, by minute order, approve the Plans and Specifications and authorize to bid the AmeriCorps Trail Extension Contract No. 2022-03.

Attachments:

- 1 Project Location Map
- 2 Project Plans and Specifications

LOCATION MAP

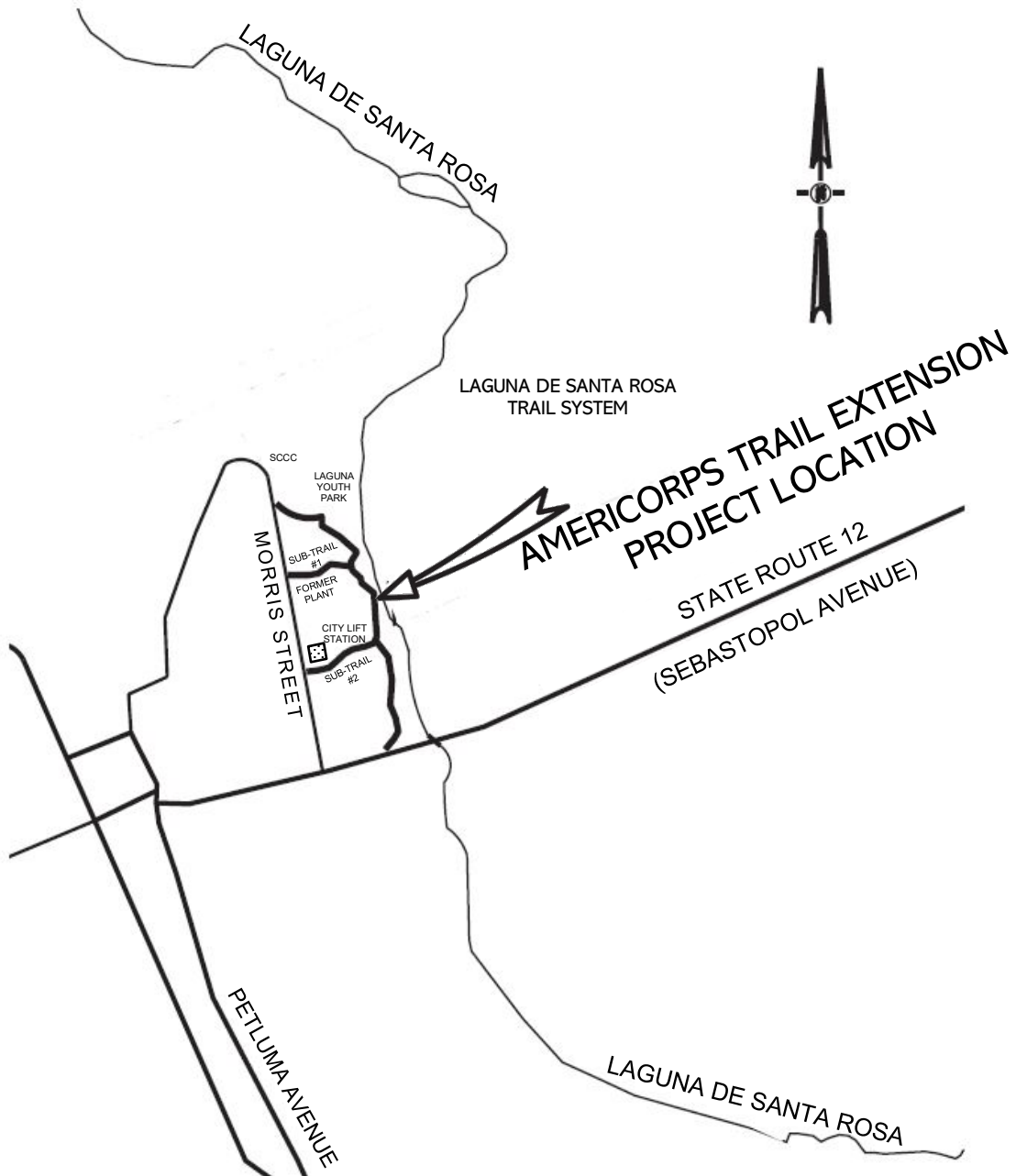

CITY OF SEBASTOPOL



NOTICE TO BIDDERS, PROPOSAL, CONTRACT

FOR

CONSTRUCTION OF THE

AMERICORPS TRAIL AND ZIMPHER CREEK BRIDGE CROSSING

CONTRACT NO. 2022-03

BID OPENING DATE:

CITY OF SEBASTOPOL
ENGINEERING DEPARTMENT
714 Johnson Street

SEBASTOPOL, CALIFORNIA 95472
PHONE: (707) 823-2151

Approved for Release:

Mario Landeros, City Engineer

Date

NOTICE TO BIDDERS

NOTICE IS HEREBY GIVEN that sealed bids will be received by the City Engineer of the City of Sebastopol at the Engineering Department located 714 Johnson Street, Sebastopol, County of Sonoma, State of California, until the hour of 2:00 p.m., on the _____ day of _____, 2023 at which time they will be publicly opened and read aloud in the conference room of the Public Works Department, 714 Johnson Street, Sebastopol, California, for:

AMERICORPS TRAIL AND ZIMPHER CREEK BRIDGE CROSSING City Contract No. 2022-03

Project plans and specifications may only be obtained by registering for the project plan holders list through Engineering Department and paying a non-refundable fee of \$50.00. Any bidder not registered for the plan holders list prior to the bid opening date shall have their bid deemed non-responsive. Questions may be directed to engineering@cityofsebastopol.org.

The Work in general consists of clearing, grading and construction of a ± 3,000 foot long stabilized decomposed granite walking trail extending from Morris Street near the Sebastopol Community Center to Sebastopol Drive (State Route 12). Improvements include a 42 long, 6 foot (clear) width, modular type pedestrian crossing of Zimpher Creek and a ± 154 foot long, 6 foot wide, puncheon trail section. The Engineer's estimate of cost is \$400,000.

In accordance with California Public Contract Code Section 3300, a valid Class A California contractor's license is required to bid on the project.

Pursuant to the provisions of Section 1720 et seq. of the Labor Code of California, the Director of Industrial Relations for the State of California has ascertained the current general prevailing rate of wages for employer purposes, in Sonoma County, State of California. Not less than the general prevailing rate of per diem wages for work of a similar character in Sonoma County and not less than the general prevailing rate of per diem wages for holiday work fixed as provided in the California Labor Code must be paid to all workers engaged in performing the project.

In accordance with the California Labor Code Section 1773.2, copies of the applicable determinations of the Director are on file in the City of Sebastopol City Engineer's Office and may be reviewed upon request.

In accordance with California Public Contract Code Section 3400, bidders may propose equals of products listed in the Special Provisions or project plans by manufacturer name, brand, or model number, unless the Special Provisions or plans specify that the product is necessary to match others in use. Complete information for products proposed as equals must be submitted to the City Engineer's Office for review at least seven (7) working days before the time specified for bid opening in accordance with the information for bidders contained in the bid package.

In accordance with California Public Contract Code Section 20170, all bids must be presented under sealed cover and include one of the following forms of bidder's security: cash, cashier's check made payable to the City, certified check made payable to the City, or a bidder's bond. The amount of bidder's security provided must equal at least ten (10) percent of the total of the bid price for the base bid and the additive or deductive items listed in this notice. The successful

bidder must submit to the City complete, executed copies of all required documents within ten (10) working days of receiving written notice of award of the project. Bidder's security of any successful bidder that fails to do so will be forfeited to the City. Such required documents include, but are not limited to, a payment or labor and materials bond in an amount of at least 100 percent of the amount payable by the terms of the project contract and that satisfies the requirements of California Civil Code Section 9554, and a performance bond in an amount of at least 100 percent of the amount payable by the terms of the contract. All project bonds must be executed by an admitted surety insurer in accordance with applicable law and acceptable to the City.

In accordance with California Public Contract Code Section 22300, except where prohibited by federal regulations or policies, the successful bidder may, on request and at its expense, substitute securities in lieu of amounts withheld by the City from progress payments to ensure performance under the contract in accordance with the contract documents.

The City of Sebastopol reserves the right to postpone the date and time for the opening of proposals at any time prior to the date and time announced in the advertisement in accordance with applicable law.

The City of Sebastopol reserves the right to reject any and all bids or to waive any defects or irregularity in bidding in accordance with applicable law. In accordance with California Public Contract Code Section 20103.8, if the City elects to award a contract for performance of the project, the contract will be awarded in accordance with California Public Contract Code Section 20162 and other applicable law to the responsible bidder submitting a responsive bid with the lowest total bid price for the base bid without consideration of the bid price for any additive or deductive items. All bids will remain valid for 90 days after the bid opening. Except as permitted by law and subject to all applicable remedies, including forfeiture of bidder's security, bidders may not withdraw their bid during the 90-day period after the bid opening.

Questions regarding this Notice may be submitted to engineering@cityofsebastopol.org.

By order of the City Council of the City of Sebastopol, Sonoma County, California.

PUBLISH: _____, 2023 and _____, 2023

/s/ Reyna Ramirez Date _____
Management Analyst

TABLE OF CONTENTS

INFORMATION FOR BIDDERS	1
1. DEFINITIONS	1
2. BIDDER'S REPRESENTATIONS	1
3. PRE-BID COMMUNICATION AND INTERPRETATION OF THE BID PACKAGE	2
4. PRE-BID ACCESS TO THE PROJECT SITE	2
5. BIDDING PROCEDURE	2
6. BID PROTESTS	4
7. AWARD	5
8. PRICING	5
9. QUANTITIES	6
10. SUBSTITUTION OF "OR EQUAL" ITEMS	6
11. SUBCONTRACTING	7
12. ASSIGNMENT	8
13. BONDS	8
14. LABOR LAWS	8
BIDDER'S CHECK LIST	10
PROPOSAL	11
BID BOND	14
CONTRACTOR LICENSE INFORMATION	15
LIST OF SUBCONTRACTORS	16
NON-COLLUSION AFFIDAVIT	19
WORKERS COMPENSATION INSURANCE CERTIFICATION	20
DEBARMENT CERTIFICATION	20
ACKNOWLEDGMENT OF INSURANCE AND INDEMNITY REQUIREMENTS	21
49CFR29 DEBARMENT AND SUSPENSION CERTIFICATION	24
PUBLIC CONTRACT CODE SECTION 10285.1 STATEMENT	25
PUBLIC CONTRACT CODE SECTION 10162 QUESTIONNAIRE	26
PUBLIC CONTRACT SECTION 10232 STATEMENT	27
BIDDER'S SIGNATURE PAGE	28
CONTRACT DOCUMENTS CHECK LIST	30
 CONTRACT	
PART 1 - AGREEMENT	31
100% PERFORMANCE BOND	31
50% PAYMENT BOND	35
MAINTENANCE BOND	37
ESCROW AGREEMENT	39

PART 2 - GENERAL PROVISIONS	42
SECTION 1 Definitions	42
SECTION 2 Scope of Work	44
SECTION 3 Control of Work and Material	46
SECTION 4 Changes in Work	51
SECTION 5 Trenching and Utilities	54
SECTION 6 Project Facilities	57
SECTION 7 Prosecution and Progress of the Work	58
SECTION 8 Contractor Responsibilities	61
SECTION 9 Measurement and Payment	70
SECTION 10 Project Acceptance and Closeout	74
SECTION 11 Remedies and Disputes	75
SECTION 12 Additional Provisions	80
SECTION 13 Safety Rules and Requirements	88
PART 3 - SPECIFICATIONS	91
SECTION 14-1 General	91
SECTION 14-2 Technical Specifications	97
SECTION 14-3 Special Provisions	109
LIST OF APPENDICES	
General Guidelines for Construction Activities	Appendix A
Erosion and Sediment Control and Minimization of Hazardous Materials Contact with Stormwater	

INFORMATION FOR BIDDERS

1. DEFINITIONS

- 1.1 Bid forms. The bid forms are the forms listed in the Bid Forms Section in the bid package Table of Contents.
- 1.2 Bid package. A complete bid package consists of the following documents: Notice to Bidders, Information for Bidders, Bidder's Check List, Proposal and Schedule of Bid Prices, Bid Bond, Contractor License Information, List of Proposed Subcontractors, Workers Compensation Insurance Certification, Acknowledgement of Indemnity and Insurance Requirements Non-collusion Affidavit, Public Contract Code Section 10285.1, Public Contract Code Section 10162 Questionnaire, Public Contract Code Section 10232 Statement, Debarment and Suspension Certification, Bidder's Signature Page, Contract Document Check List, Contract, Part 1, Performance Bond, Payment and Maintenance Bond, Maintenance Bond, Escrow Agreement, General Provisions, Special Provisions , the Project Plans.
- 1.3 Business day. The City is open for business Monday through Thursday, excluding holidays, from 7:00 a.m. to 5:30 p.m. (Note that the office is closed noon – 12:30 p.m. for lunch.)
- 1.4 Contract documents. All of the documents incorporated into the final Project contract as listed in the contract, as described in the Contract.
- 1.5 Project. The Project is the AmeriCorps Trail and Zimpher Creek Bridge Crossing as described in the bid package.
- 1.6 Project Plans. The Project Plans are the primarily graphic detailed requirements concerning the Project contained in the bid package.
- 1.7 Special Provisions, Part 3. The Special Provisions provide detailed requirements concerning the Project.

2. BIDDER'S REPRESENTATIONS

Each bidder by submitting a bid represents that:

- 2.1 The bidder has read and understands the bid package and the bid is in accordance with all the requirements of the bid package and applicable law.
- 2.2 Neither the bidder nor any subcontractor included on the list of proposed subcontractors submitted with the bid are ineligible to perform work on public works projects pursuant to California Labor Code Sections 1777.1 or 1777.7.
- 2.3 The bidder understands that quantities of unit price items may vary from the estimates provided in the Special Provisions.
- 2.4 Representatives of the bidder have visited the Project site and have familiarized themselves with the conditions under which the Project work is to be performed so as to ensure that the Project work may be performed for the amount bid.

- 2.5 The bidder has informed the City in writing no later than five (5) working days prior to the time specified for bid opening of any apparent conflicts, errors, or ambiguities contained in the bid package or between the contents of the bid package and the Project site.

3. PRE-BID COMMUNICATION AND INTERPRETATION OF THE BID PACKAGE

- 3.1 Any bidder that discovers any apparent conflicts, errors, or ambiguities contained in the bid package or between the contents of the bid package and the Project site, or that has questions or requires clarification concerning the bid package or its intent must inform the City in writing as soon as reasonably possible, but no later than five (5) working days before the date specified for bid opening. Such notice to the City must be sent to the address specified in the Notice to Bidders for questions concerning the bid package. Questions received less than five (5) working days before the time specified for opening bids may not be answered.
- 3.2 Any interpretation, correction or change of the bid package prior to bid opening will be made by addendum signed by an authorized representative of the City and transmitted to all bid package recipients. No other interpretation or information concerning the bid package issued prior to the date specified for opening bids will be binding. All addenda signed by an authorized representative of the City and issued prior to the time and date specified for opening bids will form a part of the contract documents and must be acknowledged on the bid forms. Any changes, exceptions or conditions concerning the Project and/or the bid package submitted by any bidder as part of a bid may render that bid non-responsive.

4. PRE-BID ACCESS TO THE PROJECT SITE

- 4.1 Prior to submitting a bid, it will be the sole responsibility of each bidder to conduct any additional examination, investigation, exploration, test, study or other inquiry and to obtain any additional information pertaining to the physical conditions (including surface, subsurface, and underground utilities) at or near the Project site that may affect the cost, progress, or performance of the Project, and that the bidder deems are necessary to prepare its bid for performance of the Project in accordance with the bid package and contract documents. Bidders seeking any such additional examination or other inquiries or information concerning the Project will do so at the bidder's sole expense.
- 4.2 Bidders seeking to conduct any additional examination or other inquiry at the Project site must request site access from the City at least two (2) working days in advance. The location of any excavation, boring or other invasive testing will be subject to approval on behalf of the City and any other agencies with jurisdiction over such testing. Bidders may not conduct tests at the Project site prior to obtaining City approval. The City may require bidders to execute an access agreement prior to approving testing at the Project site. Once approved testing is complete, Bidders must fill all trenches or holes, restore all pavement to match existing structural section, and otherwise clean up and restore the test site to its pre-test condition.

5. BIDDING PROCEDURE

- 5.1 Bids must be delivered to the City of Sebastopol, 714 Johnson Street, Sebastopol, California 95472, no later than the time and date specified in the Notice to Bidders. Bids

will be opened and read publicly at that time. Bids that are submitted late according to the official time kept by the Public Works Management Analyst or a designee will be returned unopened. Telephones for use by bidders are not available at the City offices.

- 5.2 In accordance with California Public Contract Code Section 20170, bids must be presented under sealed cover. Bids must be submitted using the bid forms furnished with the bid package. Bids must include all documents listed in the Bidder's Check List completed in accordance with the bid package. Bids must bear the bidder's legal name and be signed by a representative authorized to bind the bidder. Bids must be typed or written in ink. Corrections may be made if initialed by the individual signing the bid. No oral or telegraphic modifications of bids, including facsimile modifications, will be considered. Bids that are incomplete or that are not presented on the bid forms furnished with the bid package may be deemed non-responsive.
- 5.3 Each bid must give the full business address of the bidder. Bids of partnerships must furnish the full name of all partners and must be signed in the partnership name by one of the members of the partnership, or by an authorized representative, followed by the printed name and title of the person signing. Bids of corporations must be signed with the legal name of the corporation, followed by the name of the state of incorporation and by the signature and designation of the president, secretary or other person authorized to bind the corporation. The name of each person signing must also be typed or printed below the signature. Upon request of the City, bidders will furnish satisfactory evidence of the authority of the person signing the bid. Bids of joint ventures must include a certified copy of the legal agreement constituting the joint venture.
- 5.4 No person, firm, corporation, partnership or legal joint venture may submit more than one bid for the Project. However, a person, firm, corporation, partnership or legal joint venture that has submitted a subcontract proposal to a bidder, or that has quoted prices on materials to a bidder may submit a subcontract proposal, quote prices to other bidders and submit its own bid.
- 5.5 In accordance with California Public Contract Code Section 20170, all bids must include one of the forms of bidder's security specified in the Notice to Bidders in an amount of at least ten (10) per cent of the total of the bid prices for the base bid and those additive or deductive items specifically identified in the Notice to Bidders for the purpose of determining the lowest price bid. Bidders that elect to provide bidder's security in the form of a bid bond must execute a bid bond using the form provided in the bid forms. The bidder's security is tendered as a guarantee that the successful bidder, if issued a notice of award concerning the Project contract, will execute and submit to the City all required bonds, certificates of insurance, completed contract forms and other documents listed in the Contract Check List and enter into a contract with the City within ten (10) working days of receipt of the notice of award. The bidder's security of any successful bidder that fails to do so will be forfeited to the City. All bidders' security not forfeited to the City will be returned once a successful bidder provides all required documents and enters a contract with the City in accordance with all applicable bid package requirements. Forfeiture of the bidder's security to the City will not waive or otherwise limit any other remedy available to the City under applicable law.
- 5.6 In accordance with California Business and Professions Code Section 7028.15, Public Contract Code Section 20103.5, and as specified in the Notice to Bidders, all Project work must be performed by properly licensed contractors and subcontractors with active licenses in good standing as of the date and time specified for bid opening, or, if the

Project involves federal funds, no later than the time the Project contract is awarded. Bidders must verify their Contractor's License number and license expiration date in the proposal under penalty of perjury. Bids that do not satisfy applicable licensing requirements will be considered non-responsive and rejected and may subject the bidder to criminal and/or civil penalties.

- 5.7 Pursuant to Labor Code Section 1771.1(a), a contractor or subcontractor shall not be qualified to bid on, be listed in a bid proposal, subject to the requirements of Section 4104 of the Public Contract Code or engage in the performance of any contract for public work, as defined in Part 7, Chapter 1 of the Labor Code., unless currently registered and qualified to perform public work pursuant to Labor Code Section 1725.5. It is not a violation of Labor Code Section 1771.1 for an unregistered contractor to submit a bid that is authorized by Section 7029.1 of the Business and Professions Code or Section 10164 or 20103.5 of the Public Contract Code, provided the contractor is registered to perform public work pursuant to Labor Code Section 1725.5 at the time the contract is awarded.
- 5.8 If the bid forms include a bidder's questionnaire, all bids must include a completed bidder's questionnaire on the forms provided. By submitting a bid, bidders authorize City representatives to verify any and all information provided on the bidder's questionnaire and agree to indemnify, defend and hold harmless the City and its officials, officers, employees, agents and volunteers to the full extent permitted by law from and against any claims, liability or causes of action, including, without limitation, legal fees and costs, arising out of verification of the information provided on the bidder's questionnaire, and/or arising out of use of information provided in the bidder's questionnaire to determine, in accordance with applicable law, the qualification of the bidder to perform the Project.
- 5.9 Bids may be withdrawn prior to the time set for bid opening by a written request signed by an authorized representative of the bidder filed with the Management Analyst. The bid security submitted with bids so withdrawn will be returned to the bidder. Bidders that have withdrawn their bid in accordance with this provision may submit a new bid prior to the time set for bid opening in accordance with all applicable bid package requirements. Bids may not be withdrawn during the ninety-day period after the time set for bid opening except as permitted by law pursuant to California Public Contract Code Section 5100 and following. Any other bid withdrawal will result in forfeiture of the bidder's bid security to the City.

6. BID PROTESTS

- 6.1 Any protest of the proposed Project award must be submitted in writing to the City and received at the City, Public Works Office, 714 Johnson Street, Sebastopol, no later than 5:00 PM on the third business day following the date of the bid opening.
- 6.2 The protest must contain a complete statement of the basis for the protest.
- 6.3 The protest must state the facts and refer to the specific portion of the document or the specific statute that forms the basis for the protest. The protest must include the name, address, and telephone number of the person representing the protesting party.
- 6.4 The party filing the protest must concurrently transmit a copy of the protest to the proposed awardee.

- 6.5 The party filing the protest must have submitted a bid for the Project. A subcontractor of a party filing a bid for the Project may not submit a bid protest. A party may not rely on the bid protest submitted by another bidder but must timely pursue its own protest.
- 6.6 The procedure and time limits set forth in these Information for Bidders are mandatory and are the bidders' sole and exclusive remedy in the event of a bid protest. Any bidder's failure to fully comply with these procedures will constitute a waiver of any right to further pursue a bid protest, including filing of a challenge of the award pursuant to the California Public Contract Code, filing of a claim pursuant to the California Government Code, or filing of any other legal proceedings.
- 6.7 The City will review all timely protests prior to award of the contract. The City will not be required to hold an administrative hearing to consider any protests, but may do so at its option. At the time of the City Council's consideration of the award, the City Council will also consider the merits of any timely protests. The City Council may either reject the protest and award to the lowest responsible bidder or accept the protest and award the bid to the next lowest responsible bidder. Nothing in this section will be construed as a waiver of the City Council's right to reject all bids.

7. AWARD

- 7.1 In accordance with applicable law, the City reserves the right to reject any or all bids and to waive any informality in any bid. The City reserves the right to accept any portion of any bid, unless the bid package expressly provides that the award will be made as a whole. If the City elects to award a contract for performance of the Project, the contract will be awarded in accordance with California UPCCAA under the Public Contract Code Section 22000, et. seq. and other applicable law to the responsible bidder submitting a responsive bid with the lowest total bid price for the base bid and the additive or deductive alternate items listed in the Notice to Bidders. In accordance with the contract documents and applicable law, the City may add or deduct items of work from the Project after the lowest responsible bidder is determined.
- 7.2 The successful bidder must submit to the City complete, executed copies of all documents specified in the Contract Checklist within ten (10) working days of receiving written notice of award of the Project. Bidder's security of any successful bidder that fails to do so will be forfeited to the City.
- 7.3 The successful bidder and any subcontractors and others engaged in performance of the Project must have valid local business license(s), as applicable, before commencing work on the Project.
- 7.4 Upon verifying that the successful bidder has provided complete, executed copies of all documents specified in the Contract Checklist an authorized City representative will execute the Project contract, and the City will issue to the successful bidder a notice to proceed specifying the Project commencement date. The number of days within which the Project must be complete begins to run on the Project commencement date.

8. PRICING

- 8.1 If an inconsistency exists between the amount listed for a unit price in a bid and the total listed for that bid item (e.g., if the total listed for a bid item does not equal the unit price

listed in the bid multiplied by the quantity listed), subject to applicable law, the unit price will be deemed to accurately reflect the bidder's intent concerning the bid item and the intended total for the bid item will be deemed to be the unit price as listed in the bid multiplied by the quantity listed.

- 8.2 If the Project bid price is a lump sum total made up of smaller individual bid item prices and an inconsistency exists between the lump sum total bid price and any individual bid item price, subject to applicable law, the individual bid item prices as listed in the bid will be deemed to accurately reflect the bidder's intended bid for the Project and the intended lump sum total bid for the Project will be deemed to be the sum of the individual bid item prices as listed in the bid, even if that sum is different from the amount actually listed as the lump sum total bid for the Project.
- 8.3 Any federal, state, or local tax payable on articles to be furnished for the Project will be included in the lump sum total bid price and paid by the Contractor under the contract. The City is exempt from federal excise tax and will provide a certificate of exemption to the successful bidder upon request.

9. QUANTITIES

- 9.1 Quantities, including but not limited to, material or labor quantities, that are provided in the bid package concerning the Project are estimates only and are provided solely as a general indication of the Project scope. The City does not warrant that such quantity estimates provided in the bid package represent the actual quantities required to perform the Project in accordance with the contract documents. Such quantity estimates do not bind the City, and bidders should not rely on them in preparing their bids. Each bidder is solely responsible for determining the quantities on which to base their bids in light of information contained in the bid package, bidder investigation and analysis of the Project and the Project site, and any other analysis or expertise of the bidder concerning the Project.
- 9.2 The City may amend, decrease or increase the Project work in accordance with the bid package and the contract documents. If the City amends, decreases or increases the Project work prior to award of the Project each bidder will be solely responsible for determining the revised quantities, if any, on which to base their bid in light of information contained in the bid package and any amendments or addenda to the bid package, bidder investigation and analysis of the Project as amended, decreased or increased, the Project site, and any other analysis or expertise of the bidder concerning the Project.

10. SUBSTITUTION OF "OR EQUAL" ITEMS

- 10.1 In accordance with California Public Contract Code Section 3400, where the Special Provisions or Project Plans list products by manufacturer's name, brand or model number such information indicates the quality and utility of the items desired and does not restrict bidders to that manufacturer's name, brand or model number, unless the Special Provisions or Project Plans specify that the listed product is necessary to match others in use on a particular public improvement either completed or in the course of completion. Except where the Special Provisions indicate that a particular brand product is necessary to match others in use, when a manufacturer's name, brand or model number is listed, it will be construed to be followed by the words "or equal" whether or not those words in fact follow the manufacturer's name, brand name or model number listed in the Special Provisions or Project Plans. Unless the Special Provisions or Project

Plans indicate that a particular brand product is necessary to match others in use, bidders may propose equals of products listed by manufacturer name, brand name or model number.

- 10.2 Complete information for products proposed as equals must be submitted to the City for review at least seven (7) working days before the time specified for opening bids. To be considered, proposals concerning products proposed as equals must include sufficient information to permit the City to determine whether the products proposed as equals will satisfy the same performance requirements as products listed by manufacturer name, brand or model number. Such performance requirements may include, but are not limited to, size, strength, function, appearance, ease of maintenance and repair, and useful life requirements. Proposals concerning products proposed as equals that are submitted less than seven (7) days before the time specified for opening bids will not be considered. Failure to bid products specified by manufacturer name, brand name or model number where the Special Provisions or Project Plans specify that a particular product is necessary to match others in use, or where no proposal concerning products proposed as equals has been submitted in accordance with this provision may render a bid non-responsive.

11. SUBCONTRACTING

- 11.1 Bids must be in accordance with the requirements of the Subletting and Subcontracting Fair Practices, Act, California Public Contract Code Section 4100 and following. Bids must include a completed list of proposed subcontractors on the form included in the bid package. In accordance with California Public Contract Code Section 4104, completed lists of proposed subcontractors must include the name, business location, the portion (type or trade), and dollar amount of the Project work to be subcontracted for each subcontractor that will perform a portion of the Project work (including special fabrication and installation of a portion of the work) valued in excess of one half of one percent of the total Project bid price. If the Project work includes construction of streets or highways, the completed list of proposed subcontractors must include the subcontractor name, business location, type of work and dollar amount to be subcontracted for each subcontractor that will perform a portion of the Project work (including special fabrication and installation of a portion of the work) valued in excess of one half of one percent of the total Project bid price, or ten thousand dollars (\$10,000), whichever is greater.
- 11.2 In accordance with California Public Contract Code Section 4106, for any portion of the Project work with a value of more than one half of one percent of the total Project bid price for which no subcontractor is listed, or for which more than one subcontractor is listed, bidders certify by submitting their bids that they are qualified to perform that portion of the Project work and that they will perform that portion of the Project work with their own forces. Bidders may not substitute another subcontractor for a subcontractor listed in their bid except as permitted by the City in accordance with Section 4107 and following of the California Public Contract Code.
- 11.3 The Contractor must perform with his or her own organization a value of work amounting to not less than 50% of the contract amount in accordance with the Contract.
- 11.4 Subcontractors must meet all applicable indemnification and insurance requirements as detailed in the Acknowledgement of Indemnity and Insurance Requirement.

12. ASSIGNMENT

- 12.1 Bidders may not assign, sublet, sell, transfer, or otherwise dispose of their bid or any right, title or interest in their bid, or their obligations under their bid, without the written consent of an authorized representative of the City. Any purported assignment, subletting, sale, transfer or other disposition of a bid or any interest in a bid, or of any obligations under a bid without such written consent will be void and of no effect.

13. BONDS

- 13.1 The successful bidder must submit to the City a performance bond within ten working days of receiving written notice of award. If the Project involves expenditures in excess of twenty-five thousand dollars (\$25,000), the successful bidder must submit to the City a payment or labor and materials bond within 10 days of the date of mailing of the notice of award. Prior to issuance of the final Project payment, the successful bidder must submit a warranty or maintenance bond. All bonds must be executed by corporate sureties who are admitted surety insurers in the State of California in accordance with applicable law and acceptable to the City. Individual sureties will not be accepted. All Project bonds must be executed using the forms provided in the bid package.
- 13.2 In accordance with California Civil Code Section 9554, the payment or labor and materials bond must be in the amount of one hundred percent of the total amount payable by the terms of the Project contract and guarantee payment to persons listed in California Civil Code Section 9100(a) for work performed and for charges for materials, supplies, and equipment provided under the Project contract (including amounts due under or subject to the Unemployment Insurance Code) in accordance with the requirements of California Civil Code Section 9554.
- 13.3 The performance bond must be in the amount of one hundred percent of the amount payable by the terms of the Project contract to guarantee the faithful performance of the Project work.
- 13.4 The warranty or maintenance bond must be in the amount of ten percent of the final Project contract amount and guaranty the Project work against defects in materials, equipment, workmanship, or needed repair for one year from the City's acceptance of the Project work. A warranty or maintenance bond that meets these requirements must be submitted to the City prior to issuance of final Project payment.

14. LABOR LAWS

- 14.1 Bidders must comply with applicable provisions of the California Labor Code.
- 14.2 In accordance with California Labor Code Section 1861, bids must include a workers compensation insurance certification on the form included in the bid package.
- 14.3 In accordance with California Labor Code Section 1771, not less than the general prevailing rate of per diem wages for work of a similar character in the locality in which the Project is to be performed, and not less than the general prevailing rate of per diem wages for holiday and overtime work fixed as provided in the California Labor Code must be paid to all workers engaged in performing the Project.

- 14.4 In accordance with California Labor Code Part 7, Chapter 1m Article 2, Sections 1770, 1773, and 1173.2 and following, the Director of Industrial Relations has determined the general prevailing wage per diem rates for work in the locality in which the Project is to be performed. In accordance with California Labor Code Section 1773, the City has obtained the general prevailing rate of per diem wages and the general rate for holiday and overtime work in the locality in which the Project is to be performed for each craft, classification or type of worker needed to perform the Project. In accordance with California Labor Code Section 1773.2, copies of the prevailing rate of per diem wages are on file at the City offices and will be made available on request. The Contractor can also download this information from the website: <http://www.dir.ca.gov/dlsr/PWD/>.
- 14.5 In accordance with California Labor Code Section 1777.1, contractors and subcontractors that are found guilty of willfully violating Chapter 1 of Part 7 of Division 2 of the Labor Code (except for Section 1777.5), or that are found guilty of such violations with intent to defraud, and entities in which such contractors or subcontractors have any interest, may be ineligible to bid on, be awarded, or perform Project work as a subcontractor.
- 14.6 Pursuant to, Labor Code Section 1771.1(a), a contractor or subcontractor shall not be qualified to bid on, be listed in a bid proposal, subject to the requirements of Section 4104 of the Public Contract Code, or engage in the performance of any contract for public work, as defined in Part 7, Chapter 1 of the Labor Code, unless currently registered and qualified to perform public work pursuant to Labor Code Section 1725.5. It is not a violation of Labor Code Section 1771.1 for an unregistered contractor to submit a bid that is authorized by Section 7029.1 of the Business and Professions Code or Section 10164 or 20103.5 of the Public Contract Code, provided the contractor is registered to perform public work pursuant to Labor Code Section 1725.5 at the time the contact is awarded.

BIDDER'S CHECK LIST

Did You:

- _____ Submit equal product proposals, if any, in accordance with the information for bidders included in the bid package at least 7 days before the time specified for bid opening?
- _____ Include with your bid properly completed, accurate copies of the following documents in the following order using the forms included in the bid package:
 - _____ Bidder's check list
 - _____ Proposal and Schedule of Bid Prices that state the bid as intended
 - _____ Copies of each Addendum issued signed and dated on behalf of the bidder
 - _____ Executed Bid Bond
 - _____ Contractor License Information
 - _____ List of Proposed Subcontractors
 - _____ Signed Title 23 USC Section 112 and Public Contract Code 7106 Non-Collusion Affidavit
 - _____ Signed Workers compensation insurance & Public Contract Code 6109 Debarment certification
 - _____ Signed Acknowledgment of Insurance and Indemnity Requirements
 - _____ Signed Title 49 CFR Part 29 Debarment and Suspension Certifications
 - _____ Public Contract Code Section 10285.1 Statement
 - _____ Public Contract Code Section 10162 Questionnaire
 - _____ Public Contract Section 10232 Statement
 - _____ Executed Bidder's Signature Page
- _____ Arrange to have the sealed bid delivered to the City of Sebastopol offices at 714 Johnson Street, Sebastopol, California, 95472 on or before 2:00 p.m. on the Bid Date specified in the Notice to Bidders, or as amended by Addendum.

PROPOSAL

For: Construction of AmeriCorps Trail and Zimpher Creek Bridge Crossing

For the City of Sebastopol, Sonoma County, California.

TO THE HONORABLE CITY COUNCIL
OF THE CITY OF SEBASTOPOL

The undersigned, as bidder, declares that he/she has carefully examined the work, the annexed proposed form of contract, and agrees that if this Proposal is accepted that he/she will contract with the City of Sebastopol, under the form of contract annexed of hereto, to provide all the necessary tools, apparatus, and other means of accomplishing the work as specified in the contract in the manner and time herein prescribed, and in accordance with the requirements of the Engineer as therein set forth, and he/she will take in full payment therefore the following prices for the work to be done completely performed to the satisfaction of the City of Sebastopol, to-wit:

SCHEDULE OF BID PRICES

Item No.	Item Description	Estimated Quantity	Unit of Measure	Unit Cost (in figures)	Total Cost (in figures)
1	Mobilization	1	LS		
2	Storm Water Pollution Prevention Plan	1	LS		
3	Erosion and Sediment Control Plan	1	LS		
4	Clear and Grub	1	LS		
5	Earthwork	1,150	CU.YDS.		
6	Class 2 Agg. Base	57	TONS		
7	Weed Barrier Fabric	21,800	SF		
8	Stabilized Decomposed Granite	29	TONS		
9	Metal Path Edging	5,450	LF		
10	6" x 2" Pressure Treated Douglas Fir	2,170	BOARD FEET		
11	4" X 4" Pressure Treated Douglas Fir	520	BOARD FEET		
12	Concrete Pier Blocks	70 EA	EA		
13	Concrete Bridge Footings	6	CU.YDS.		
14	42 Ft (span) by 6 Ft (wide) Modular Bridge	1	LS		
15	Project Area Signs	6	EA		
16	Removable Bollards	2	EA		
17	12" Dia x 15' Long HDPE Culverts	13	EA		
18					
19					
20					
21					
22					

23					
24					
25					
26					
27					
28					
29					
30					
31					
32					
33					
34					
35					

Total Base Bid \$ _____

Written in words _____

Within 10 days of the date of mailing of the notice of award, the undersigned agrees to enter into and execute and provide to the City the necessary contract with the necessary bonds and other required documents, and in case of default in executing the necessary contract within the time fixed by the Information for Bidders, the bidder's security accompanying this bid will become the property of and be forfeited to the City of Sebastopol.

Prime Contractor _____

License # _____ Expiration Date: _____

Name of person submitting bid: _____ Email: _____

The Contractor's license number and expiration date are herein stated under penalty of perjury.

By: _____ Title: _____

Dated this _____ day of _____, 20____

CORPORATION

(Corporate Seal)

Corporate signature

Address: _____

Phone No.: _____

President's signature _____

Secretary's signature _____

Corporation organized under the laws of the State of _____

PARTNERSHIP

Partnership Name: _____

Address: _____

Names of Co-Partners and Addresses: _____

SOLE PROPRIETORSHIP

Names of Individuals and Addresses: _____

NOTE: Sign in proper space above.

DRAFT

BID BOND

(NOTE: Bidders must use this form. Use of any other bond form may render a bid non-responsive)

KNOW ALL MEN BY THESE PRESENTS, that we, the undersigned, _____ as Principal, and _____ as Surety, are hereby held and firmly bound unto the CITY OF SEBASTOPOL, as owner in the penal sum of \$ _____ for the payment of which, well and truly to be made, we hereby jointly and severally bind ourselves, our heirs, executors, administrators, successors and assigns.

Signed this _____ day of, _____ 20.

The condition of the above obligation is such that whereas the Principal has submitted to the CITY OF SEBASTOPOL a certain Bid, attached hereto and hereby made a part hereof to enter in a contract in writing for the

**AmeriCorps Trail and Zimpher Creek Bridge Crossing
Contract No. 2022-03**

NOW, THEREFORE,

- a) If said Bid shall be rejected, or in the alternate,
- b) If said Bid shall be accepted and the Principal shall execute and deliver a contract in the Form of Contract attached hereto (properly completed in accordance with said Bid) and shall furnish a bond for his faithful performance of said contract, and for the payment of all persons performing labor or furnishing materials in connection therewith, and shall in all other respects perform the agreement created by the acceptance of said Bid, then this obligation shall be void, otherwise the same shall remain in force and effect; it being expressly understood and agreed that the liability of the Surety for any and all claims hereunder, in no event, exceed the penal amount of this obligation as herein stated. The Surety for value received, hereby stipulated and agrees that the obligations of said surety and its bond shall be in no way impaired or affected by any extension of the time within which the City may accept such Bid; and said Surety does hereby waive notice of any such extension.

IN WITNESS WHEREOF, the Principal and the Surety have hereunto set their hands and seals, and such of them are corporations have caused their corporate seals to be hereto affixed and these presents to be signed by their proper officers, the day and year first set forth above.

Principal

Surety

SEAL

BY: _____

(NOTE TO SURETY COMPANY: A certified copy of unrevoked resolution of authority for the attorney-in-fact must be submitted with and attached to the executed bid bond.)

CONTRACTOR LICENSE INFORMATION

The bidder acknowledges that the license required for performance of the [Project Name] Project is a Class A.

The bidder holds the following California Contractors License(s):

- 1. License No. _____, Class _____, Expiration Date _____
- 2. License No. _____, Class _____, Expiration Date _____
- 3. License No. _____, Class _____, Expiration Date _____
- 4. License No. _____, Class _____, Expiration Date _____
- 5. License No. _____, Class _____, Expiration Date _____
- 6. License No. _____, Class _____, Expiration Date _____
- 7. License No. _____, Class _____, Expiration Date _____
- 8. License No. _____, Class _____, Expiration Date _____
- 9. License No. _____, Class _____, Expiration Date _____
- 10. License No. _____, Class _____, Expiration Date _____

Bidder's Taxpayer Identification No. _____

Public Works Contractor DIR Registration # _____

LIST OF PROPOSED SUBCONTRACTORS

In accordance with the requirements of the Subletting and Subcontracting Fair Practices, Act, California Public Contract Code Section 4100 and following, listed below are the name, business location, and the portion (type or trade) of the Project work to be subcontracted to each subcontractor that will perform a portion of the Project work (including special fabrication and installation of a portion of the work) valued in excess of one half of one percent of the total bid price. If the Project work includes construction of streets or highways, listed below are the name, business location, and the portion (type or trade) of the Project work to be subcontracted to each subcontractor that will perform a portion of the Project work (including special fabrication and installation of a portion of the work) valued in excess of one half of one percent of the total Project bid price, or ten thousand dollars, whichever is greater. Also listed below are the proposed subcontract dollar amount and current California Contractor's License Number(s) for each proposed subcontractor. Bids that fail to include complete proposed subcontractor information in accordance with this form and Public Contract Code Section 4100 and following may be deemed non-responsive.

In accordance with California Public Contract Code Section 4106, for any portion of the Project work with a value of more than one half of one percent (0.5%) of the total bid price for which no subcontractor is listed, or for which more than one subcontractor is listed, the bidder certifies by submission of its bid that the bidder is qualified to perform that portion of the Project work and that the bidder will perform that portion of the Project work with its own forces. The penalties listed in California Public Contract Code Section 4111 will apply to any substitution of another subcontractor for a subcontractor listed below except as permitted by the City in accordance with Section 4107 and following of the California Public Contract Code.

The Contractor must perform with his or her own organization, a value of work amounting to not less than fifty percent (50%) of the contract amount, except that the bid amount for "Specialty Items" so designated in any Special Provisions if included may be eliminated from the contract amount and not considered as sub-contracted for the purposes of calculating the value of work to be performed by the Contractor. For the purposes of determining the value of work to be performed by the Contractor pursuant to this provision, materials, equipment, incidentals, etc., shall be considered to have been purchased by the contractor or subcontractor that is to install them. Where a portion of an item is subcontracted, the value of work subcontracted will be based on the estimated cost of such portion of the subcontracted item, as determined from information submitted by the Contractor, subject to approval by the Engineer.

1. Subcontractor Name _____
 Business Location _____
 Trade _____
 Subcontract Amount _____
 Current Contractor's License No.(s) _____
 Public Works Contractor DIR Registration # _____
2. Subcontractor Name _____
 Business Location _____
 Trade _____
 Subcontract Amount _____
 Current Contractor's License No.(s) _____

Public Works Contractor DIR Registration # _____

3. Subcontractor Name _____

Business Location _____

Trade _____

Subcontract Amount _____

Current Contractor's License No.(s) _____

Public Works Contractor DIR Registration # _____

4. Subcontractor Name _____

Business Location _____

Trade _____

Subcontract Amount _____

Current Contractor's License No.(s) _____

Public Works Contractor DIR Registration # _____

5. Subcontractor Name _____

Business Location _____

Trade _____

Subcontract Amount _____

Current Contractor's License No.(s) _____

Public Works Contractor DIR Registration # _____

6. Subcontractor Name _____

Business Location _____

Trade _____

Subcontract Amount _____

Current Contractor's License No.(s) _____

Public Works Contractor DIR Registration # _____

7. Subcontractor Name _____

Business Location _____

Trade _____

Subcontract Amount _____

Current Contractor's License No.(s) _____

Public Works Contractor DIR Registration # _____

8. Subcontractor Name _____

Business Location _____

Trade _____

Subcontract Amount _____

Current Contractor's License No.(s) _____

Public Works Contractor DIR Registration # _____

9. Subcontractor Name _____

Business Location _____

Trade _____

Subcontract Amount _____

Current Contractor's License No.(s) _____

Public Works Contractor DIR Registration # _____

10. Subcontractor Name _____

Business Location _____

Trade _____

Subcontract Amount _____

Current Contractor's License No.(s) _____

Public Works Contractor DIR Registration # _____

DRAFT

NON-COLLUSION AFFIDAVIT

**TO BE EXECUTED BY BIDDER
AND SUBMITTED WITH BID**

(Title 23 United States Code Section 112 and Public Contract Code Section 7106)

The undersigned declares:

I am the _____ of _____, the party making the foregoing bid. The bid is not made in the interest of, or on behalf of, any undisclosed person, partnership, company, association, organization, or corporation. The bid is genuine and not collusive or sham. The bidder has not directly or indirectly induced or solicited any other bidder to put in a false or sham bid. The bidder has not directly or indirectly colluded, conspired, connived, or agreed with any bidder or anyone else to put in a sham bid, or to refrain from bidding. The bidder has not in any manner, directly or indirectly, sought by agreement, communication, or conference with anyone to fix the bid price of the bidder or any other bidder, or to fix any overhead, profit, or cost element of the bid price, or of that of any other bidder. All statements contained in the bid are true. The bidder has not, directly or indirectly, submitted his or her bid price or any breakdown thereof, or the contents thereof, or divulged information or data relative thereto, to any corporation, partnership, company, association, organization, bid depository, or to any member or agent thereof, to effectuate a collusive or sham bid, and has not paid, and will not pay, any person or entity for such purpose.

Any person executing this declaration on behalf of a bidder that is a corporation, partnership, joint venture, limited liability company, limited liability partnership, or any other entity, hereby represents that he or she has full power to execute, and does execute, this declaration on behalf of the bidder.

I declare under penalty of perjury under the laws of the State of California that the foregoing is true and correct and that this declaration is executed on _____, at _____, _____.

Signature of Bidder

WORKERS COMPENSATION INSURANCE CERTIFICATION

By submitting its bid, the bidder certifies as follows:

I am aware of the provisions of California Labor Code Section 3700, which require every employer to be insured against liability for workmen's compensation or to undertake self-insurance in accordance with the provisions of the Labor Code, and I will comply with such provisions before commencing performance of the work of this Contract.

DEBARMENT CERTIFICATION

By submitting its bid, the bidder certifies in accordance with California Public Contract Code Section 6109 that neither the bidder nor any subcontractor included on the list of proposed subcontractors submitted with the bid is ineligible to perform work on public works projects pursuant to California Labor Code Sections 1777.1 or 1777.7. In accordance with California Public Contract Code Section 6109, contractors and subcontractors who are ineligible to perform work on public works projects pursuant to California Labor Code Sections 1777.1 or 1777.7 may neither bid on, be awarded, or perform as a contractor or subcontractor on public works projects.

Signature of Bidder

Printed Name

ACKNOWLEDGMENT OF INSURANCE AND INDEMNITY REQUIREMENTS

Contractor shall procure and maintain for the duration of the contract, and for 2 years thereafter, insurance against claims for injuries to persons or damages to property which may arise from or in connection with the performance of the work hereunder by the Contractor, his agents, representatives, employees, or subcontractors.

INSURANCE:

A. MINIMUM SCOPE AND LIMIT OF INSURANCE

Coverage shall be at least as broad as:

1. Commercial General Liability (CGL): Insurance Services Office (ISO) Form CG 00 01 covering CGL on an "occurrence" basis, including products and completed operations, property damage, bodily injury and personal & advertising injury with limits no less than \$[fill in AMOUNT] per occurrence. If a general aggregate limit applies, either the general aggregate limit shall apply separately to this project/location (ISO CG 25 03 or 25 04) or the general aggregate limit shall be twice the required occurrence limit.
2. Automobile Liability: Insurance Services Office Form CA 0001 covering Code 1 (any auto), with limits no less than \$2,000,000 per accident for bodily injury and property damage.
3. Workers' Compensation insurance as required by the State of California, with Statutory Limits, and Employers' Liability insurance with a limit of no less than \$1,000,000 per accident for bodily injury or disease.
4. Surety Bonds. Contractor shall provide the following Surety Bonds:
 1. Bid bond
 2. Performance bond
 3. Payment bond
 4. Maintenance bond

The Payment Bond and the Performance Bond shall be in a sum equal to the contract price. If the Performance Bond provides for a one-year warranty a separate Maintenance Bond is not necessary. If the warranty period specified in the contract is for longer than one year, a Maintenance Bond equal to 10% of the contract price is required. Bonds shall be duly executed by a responsible corporate surety, authorized to issue such bonds in the State of California and secured through an authorized agent with an office in California.
5. Professional Liability (if Design/Build), with limits no less than \$2,000,000 per occurrence or claim, and \$2,000,000 policy aggregate. The retroactive date must be shown, and this date must be before the execution date of the contract or the beginning of contract work. Insurance must be maintained and evidence of insurance must be provided for at least five (5) years after completion of contract work. If coverage is canceled or non-renewed, and not replaced with another claims-made policy form with a retroactive date prior to the contract effective, or start of work date, the Contractor must purchase extended reporting period coverage for a minimum of five (5) years after completion of contract work. A copy of the claims reporting requirements must be submitted to the City of Sebastopol for review.
6. Contractors' Pollution Legal Liability and/or Asbestos Legal Liability and/or Errors and Omissions (if project involves environmental hazards) with limits no less than \$1,000,000 per occurrence or claim, and \$2,000,000 policy aggregate. If the services involve lead-based paint or asbestos identification/remediation, the Contractors Pollution Liability policy shall not contain lead-based paint or asbestos exclusions. If the services involve mold identification/remediation,
7. the Contractors Pollution Liability policy shall not contain a mold exclusion, and the definition of Pollution shall include microbial matter, including mold.

If the contractor maintains broader coverage and/or higher limits than the minimums shown above for all policies, the City of Sebastopol requires, and shall be entitled to, the broader coverage and/or higher limits maintained by the contractor. Any available insurance proceeds in excess of the specified minimum limits of insurance and coverage shall be available to the City of Sebastopol.

B. SELF-INSURED RETENTIONS

Self-insured retentions must be declared to and approved by the City of Sebastopol. At the option of the City of Sebastopol, either: the contractor shall cause the insurer to reduce or eliminate such self-insured retentions as respects the City of Sebastopol, its officers, officials, employees, and volunteers; or the Contractor shall provide a financial guarantee satisfactory to the City of Sebastopol guaranteeing payment of losses and related investigations, claim administration, and defense expenses. The policy language shall provide, or be endorsed to provide, that the self-insured retention may be satisfied by either the named insured or the City of Sebastopol.

Other Insurance Provisions:

C. ADDITIONAL INSURED

The City of Sebastopol, its officers, officials, employees, and volunteers are to be covered as additional insureds on the CGL policy with respect to liability arising out of work or operations performed by or on behalf of the Contractor including materials, parts, or equipment furnished in connection with such work or operations and automobiles owned, leased, hired, or borrowed by or on behalf of the Contractor. General liability coverage can be provided in the form of an endorsement to the Contractor's insurance at least as broad as one of the following ISO ongoing operations Forms: CG 20 10 or CG 20 26 or CG 20 33 (not allowed from subcontractors), or CG 20 38; and one of the following ISO completed operations Forms: CG 20 37, 2039 (not allowed from subcontractors), or CG 20 40.

D. PRIMARY INSURANCE

For any claims related to this project, the Contractor's insurance coverage shall be primary insurance coverage at least as broad as ISO CG 20 01 04 13 as respects the City of Sebastopol, its officers, officials, employees, and volunteers. Any insurance or self-insurance maintained by the City of Sebastopol, its officers, officials, employees, or volunteers shall be excess of the Contractor's insurance and shall not contribute with it.

E. NOTICE OF CANCELLATION

Contractor shall provide immediate written notice if (1) any of the required insurance policies is terminated; (2) the limits of any of the required policies are reduced; (3) or the deductible or self-insured retention is increased. In the event of any cancellation or reduction in coverage or limits of any insurance, Contractor shall forthwith obtain and submit proof of substitute insurance.

F. ACCEPTABILITY OF INSURERS

Insurance is to be placed with insurers authorized to conduct business in the state with a current A.M. Best rating of no less than A: VII, unless otherwise acceptable to the City of Sebastopol.

G. WAIVER OF SUBROGATION

Contractor hereby agrees to waive rights of subrogation which any insurer of Contractor may acquire from Contractor by virtue of the payment of any loss. Contractor agrees to obtain any endorsement that may be necessary to affect this waiver of subrogation, but this provision applies regardless of whether the City of Sebastopol has received a waiver of subrogation endorsement from the insurer. However, the Workers' Compensation policy shall be endorsed with a waiver of subrogation in favor of the City of Sebastopol for all work performed by the Contractor, its employees, agents and subcontractors.

H. VERIFICATION OF COVERAGE

Contractor shall furnish the City of Sebastopol with original Certificates of Insurance including all required amendatory endorsements (or copies of the applicable policy language effecting coverage required by this clause) and a copy of the Declarations and Endorsement Page of the CGL policy listing all policy endorsements to City of Sebastopol before work begins. However, failure to obtain the required documents prior to the work beginning shall not waive the Contractor’s obligation to provide them. The City of Sebastopol reserves the right to require complete, certified copies of all required insurance policies, including endorsements, required by these specifications, at any time.

I. SUBCONTRACTORS

Contractor shall require and verify that all subcontractors maintain insurance meeting all the requirements stated herein, and Contractor shall ensure that the City of Sebastopol is an additional insured on insurance required from subcontractors. For CGL coverage subcontractors shall provide coverage with a form at least as broad as CG 20 38 04 13.

J. SPECIAL RISKS OR CIRCUMSTANCES

The City of Sebastopol reserves the right to modify these requirements, including limits, based on the nature of the risk, prior experience, insurer, coverage, or other circumstances.

INDEMNITIES

The Contractor shall defend, indemnify and hold the City of Sebastopol, its officials, officers, employees, volunteers and agents free and harmless from any and all claims, demands, causes of action, costs, expenses, liability, loss, damage or injury, in law or equity, to property or persons, including wrongful death, in any manner which actually or allegedly arise out of or are incident to any alleged acts, omissions, negligence or willful misconduct of Contractor, its officials, officers, employees, agents, and subcontractors arising out of or in connection with the performance of the Services, the Project or this Agreement, including without limitation the payment of all consequential damages and attorney’s fees and other related costs and expenses except where caused by the active negligence, sole negligence, or willful misconduct of the City, its officers, officials, employees and volunteers. The Contractor shall defend, at Contractor’s own cost, expense, and risk, any and all such aforesaid suits, actions or other legal proceedings of every kind that may be brought or instituted against the City, its directors, officials, officers, employees, agents, or volunteers. The Contractor shall pay and satisfy any judgment, award or decree that may be rendered against the City or its directors, officials, officers, employees, agents, or volunteers, in any such suit, action or other legal proceeding. The Contractor shall reimburse the City and its directors, officials, officers, employees, agents and/or volunteers, for any and all legal expenses and costs incurred by each of them in connection therewith or in enforcing the indemnity herein provided. The Contractor’s obligation to indemnify shall not be restricted to insurance proceeds, if any, received by the City, its directors, officials, officers, employees, agents or volunteers.

I have read, understand, and agree to comply with the Indemnity and Insurance requirements supplied with this notice to bidders.

Signature of Bidder

Printed Name

TITLE 49, CODE OF FEDERAL REGULATIONS - PART 29
DEBARMENT AND SUSPENSION CERTIFICATION

The bidder, under penalty of perjury, certifies that, except as noted below, he/she or any person associated therewith in the capacity of City, partner, director, officer, manager:

1. Is not currently under suspension, debarment, voluntary exclusion, or determination of ineligibility by any federal agency;
2. Has not been suspended, debarred, voluntarily excluded or determined ineligible by any Federal Agency within the past 3 years;
3. Does not have a proposed debarment pending; and,
4. Has not been indicted, convicted, or had a civil judgment rendered against it by a court of competent jurisdiction in any matter involving fraud or official misconduct within the past 3 years.

If there are any exceptions to this certification, insert the exceptions in the following space:

Exceptions will not necessarily result in denial of award but will be considered in determining bidder responsibility. For any exception noted above, indicate below to whom it applies, initiating agency, and dates of action.

Signature of Bidder

Printed Name

PUBLIC CONTRACT CODE SECTION 10285.1 STATEMENT

In accordance with Public Contract Code Section 10285.1 (Chapter 376, Stats, 1986), the bidder hereby declares under penalty of perjury under the laws of the State of California, that the bidder has ___ / has not ___ been convicted within the preceding three years of any offenses referred to in that section, including any charge of fraud, bribery, collusion, conspiracy, or any other act in violation of any state or federal antitrust law in connection with the bidding upon, award of, or performance of, any public works contract, as defined in Public Contract Code Section 1100, including the Regents of the University of California or the Trustees of the California State University. The term "bidder" is understood to include any partner, member, officer, director, responsible managing officer, or responsible managing employee thereof, as referred to in Section 10285.1.

Note: The bidder must place a check mark after "has" or "has not" in one of the blank spaces provided.

The above Statement is part of the Proposal.

Bidders are cautioned that making false certification may subject the certifier to criminal prosecution.

Signature of Bidder

Printed Name

PUBLIC CONTRACT CODE SECTION 10162 QUESTIONNAIRE

In accordance with Public Contract Code Section 10162, the Bidder shall complete, under penalty of perjury, the following questionnaire:

Has the bidder, any officer of the bidder, or any employee of the bidder who has a proprietary interest in the bidder, ever been disqualified, removed, or otherwise prevented from bidding on, or completing a federal, state, or local government project because of a violation of law or a safety regulation?

Yes _____ No _____

If the answer is "Yes", explain the circumstances in the following space.

Signature of Bidder

Printed Name

PUBLIC CONTRACT SECTION 10232 STATEMENT

In accordance with Public Contract Code Section 10232, the Contractor, hereby states under penalty of perjury, that no more than one final unappealable finding of contempt of court by a federal court has been issued against the Contractor within the immediately preceding two-year period because of the Contractor's failure to comply with an order of a federal court which orders the Contractor to comply with an order of the National Labor Relations Board.

Signature of Bidder

Printed Name

DRAFT

BIDDER’S SIGNATURE PAGE

By signing this proposal the bidder certifies, under penalty of perjury under the laws of the State of California, that the information submitted with this proposal for the [Project Name] Project (“Project”), which information includes, but is not limited to, the Bidder’s Check List, Proposal and Schedule of Bid Prices, Bid Bond, Contractor License Information, List of Subcontractors, Workers Compensation Insurance Certification, Non-collusion Affidavit, Debarment Certification, Debarment and Suspension Certification, Public Contract Code Section 10285.1 Statement, Public Contract Code Section 10162 Questionnaire, and Public Contract Code Section 10232 Statement, is accurate, true and correct, and is submitted in accordance with the requirements of the bid package issued by the City of Sebastopol concerning the Project and applicable law. By signing this proposal, the bidder representative specified below certifies that he or she is legally authorized to bind the bidder.

The bidder agrees to deliver and to complete the Project within [# days] working days from the date of issuance, by the Engineer, of instructions to proceed with the Project, and within 10 days of the date of mailing of the notice concerning the award, to enter into and execute and provide to the City the Project contract, bonds, insurance, and all other documents specified in the Contract Check List included in the bid package, and in case of default in executing the Project contract within the time fixed by the Information for Bidders, the bidder’s security accompanying this bid shall become the property of and be forfeited to the City of Sebastopol.

Prime Contractor _____

By: _____ Title: _____

Dated this _____ day of _____, 20____

(Corporate Seal)

Corporate signature

Address: _____

Phone No.: _____

President’s signature _____

Secretary’s signature _____

Corporation organized under the laws of the State of _____

Partnership Name: _____

Address: _____

Names of Co-Partners and Addresses:

Names of Individuals and Addresses:

NOTE: Sign in proper space above.

Date: _____

(Typed or printed name)

(Signature)

(Bidder)

Bidder business address (street, city, state and zip code)

Bidder Business phone: () _____

Bidder Business fax: () _____

CONTRACT DOCUMENTS CHECK LIST

Complete, accurate, executed copies of the following documents must be submitted to the City of Sebastopol in accordance with the bid package issued by the City within ten (10) working days of receiving written notice concerning award of the project. The bidder's security of any successful bidder that fails to do so will be forfeited to the City.

- _____ Contract Part 1 - Agreement
- _____ Performance Bond
- _____ Payment Bond/Labor and Material Bond
- _____ Certificates of Insurance, Declarations page(s) and Endorsements
- _____ Escrow Agreement, if applicable
- _____ Contract Part 2 - General Provisions
- _____ Special Provisions
- _____ Project Plans
- _____ Contractor Safety Program
- _____ Report of Use/Storage of Hazardous Substances

CONTRACT

PART 1 - AGREEMENT

THIS AGREEMENT, made this _____ day of _____, 20____, by and between CITY OF SEBASTOPOL, herein called "Owner," acting herein through its CITY MANAGER and

STRIKE OUT (A Corporation) (A Partnership)
INAPPLICABLE (An Individual doing business as _____)
TERMS

of _____, County of _____, State of _____, hereinafter called "Contractor."

WITNESSETH: That for and in consideration of the payment and agreement hereinafter mentioned, to be made and performed by the OWNER, the CONTRACTOR hereby agrees with the OWNER to commence and complete the construction described as follows:

**AmeriCorps Trail and Zimpher Creek Bridge Crossing
City Contract No. 2022-03**

hereinafter called the project, for the sum of _____ Dollars (\$ _____) and all extra work in connection therewith, under the terms as stated in the General Conditions and Special Provisions of the Contract; and at his or her (its or their) own proper cost and expense to furnish all the materials, supplies, machinery, equipment, tools, superintendence, labor, insurance, and other accessories and services necessary to complete the said project in accordance with the conditions and prices stated in Notice to Bidders, Bidders Proposal, the General Conditions, and Special Provisions of the Contract, the plans, which include all maps, plats, blue prints, and other drawings or written explanation matter thereof, the specifications and contract documents therefor as prepared by the City of Sebastopol Public Works Department, herein entitled the Engineer all of which are made a part hereof and collectively evidence and constitute the contract.

The Contractor hereby agrees to commence work under this contract on or before a date to be specified in a written "Notice to Proceed" of the Owner, and to fully complete the project within two hundred (200) working days. The Contractor further agrees to pay, as liquidated damages, the sum of \$1000.00 for each consecutive working day thereafter as provided in Section 7, "Prosecution and Progress of the Work" of the General Provisions.

The Owner agrees to pay the Contractor in current funds for the performance of the Contract, subject to additions and deductions, as provided in the General Conditions of the contract, and to make payments on account thereof as provided in Section 9, "Measure and Payment" of the General Provisions.

IN WITNESS WHEREOF, the parties to these presents have executed this contract in three (3) counterparts, each of which shall be deemed an original, in the year and day above mentioned.

SEAL _____
CITY OF SEBASTOPOL
(Owner)

Attest: BY: _____

(City Clerk) (City Manager)

SEAL _____
(Contractor)

BY: _____

(Secretary) (Title)

(Witness)

NOTE: Secretary of the Owner should attest. If Contractor is a corporation, Secretary should attest.

100% PERFORMANCE BOND

(NOTE: The successful bidder must use this form. Use of any other bond form may prevent a contract from forming and/or result in forfeiture of the successful bidder's bid bond)

KNOW ALL MEN BY THESE PRESENTS: That we (1) _____
_____ a (2) _____
_____ hereinafter called "Principal" and (3) _____ of _____
_____ State of _____ hereinafter called "Surety", are held and firmly
bound into (4) CITY OF SEBASTOPOL of SEBASTOPOL, CALIFORNIA hereinafter
called "Owner", in the penal sum of _____
Dollars (\$ _____) in lawful money of the United States, for the payment of which sum
well and truly to be made, we bind ourselves, our heirs, executors, administrators and successors,
jointly and severally, firmly by these presents.

THE CONDITION OF THIS OBLIGATION is such that Whereas, the Principal entered into a
certain contract with the Owner dated the _____ day of _____, 20 __, a copy of which is
hereto attached and made a part hereof for the construction of:

**AmeriCorps Trail and Zimpher Creek Bridge Crossing
City Contract No. 2022-23**

NOW, THEREFORE, if the principal shall well, truly and faithfully perform its duties, all the
undertakings, covenants, terms, conditions and agreements of said contract during the original
term thereof, and any extensions thereof which may be granted by the Owner, with or without
notice to the Surety, and if he shall satisfy all claims and demands incurred under such contract,
and shall fully indemnify and save harmless the Owner from all costs and damages which it may
suffer by reason of failure to do so, and shall reimburse and repay the Owner all outlay and
expense which the Owner may incur in making good any default, then this obligation shall be void;
otherwise to remain in full force and effect.

PROVIDED, FURTHER, that the said Surety, for value received hereby stipulates and agrees
that no change, extension of time, alteration or addition to the terms of the contract or to the work
performed thereunder or the specifications accompanying the same shall in any wise affect its
obligation on this bond, and it does hereby waive notice of any such change, extension of time,
alteration or addition to the terms of the contract or to the work or to the specifications.

PROVIDED, FURTHER, that no final settlement between the Owner and the Contractor shall
abridge the right of any beneficiary hereunder, whose claim may be unsatisfied.

IN WITNESS THEREOF, this instrument is executed in three (3) counterparts, each one of which shall be deemed an original, this the _____, day of _____, 20__.

ATTEST:

(Principal)

By: _____

(SEAL)

(Address)

Witness as to Principal

(Address)

(Surety)

ATTEST:

By: _____
Attorney-in-Fact

(Surety) Secretary

(Address)

(SEAL)

Witness as to Principal

(Address)

NOTE: Date of Bond must not be prior to date of Contract.

- (1) Correct Name of Contractor
- (2) A Corporation, a Partnership or an Individual, as case may be
- (3) Correct Name of Surety
- (4) Correct Name of Owner
- (5) If Contractor is Partnership, all partners should execute bond.

(NOTE TO SURETY COMPANY: A certified copy of unrevoked resolution of authority for the attorney-in-fact must be submitted with and attached to the executed bond.)

50% PAYMENT BOND

(NOTE: The successful bidder must use this form. Use of any other bond form may prevent a contract from forming and/or result in forfeiture of the successful bidder's bid bond)

KNOW ALL MEN BY THESE PRESENTS: That we _____
(Name of Contractor)
a _____ hereinafter called
"Principal" and
(Corporation, Partnership or Individual)
_____ of _____ State of _____
(Surety)

hereinafter called "Surety", are held and firmly bound unto the CITY OF SEBASTOPOL, 7120 BODEGA AVENUE, SEBASTOPOL, CALIFORNIA 95472, hereinafter called "Owner", in the penal sum of _ Dollars (\$) _____ in lawful money of the United States, for the payment of which sum well and truly to be made, we bind ourselves, our heirs, executors, administrators and successors, jointly and severally, firmly by these presents.

THE CONDITION OF THIS OBLIGATION is such that Whereas, the Principal entered into a certain contract with the Owner dated the _____ day of _____, 20_____, a copy of which is hereto attached and made a part hereof for the construction of:

**AmeriCorps Trail and Zimpher Creek Bridge Crossing
Contract No. 2022-03**

NOW, THEREFORE, if the principal shall promptly make payment to all persons, firms, subcontractors, and corporations furnishing materials for or performing labor in the prosecution of the work provided for in such contract, any authorized extension of modification thereof, including all amounts due for materials, lubricants, oil, gasoline, and coal, repairs on machinery, equipment and tools, consumed or used in connection with the construction of such work, and all insurance premiums on said work, and for all labor, performed in such work whether by subcontractor or otherwise then this obligation shall be void; otherwise to remain in full force and effect.

PROVIDED, FURTHER, that the said Surety, for value received hereby stipulates and agrees that no change, extension of time, alteration or addition to the terms of the contract or to the work performed thereunder or the specifications accompanying the same shall in any wise affect its obligation on this bond, and it does hereby waive notice of any such change, extension of time, alteration or addition to the terms of the contract or to the work or to the specifications.

PROVIDED, FURTHER, that no final settlement between the Owner and the Contractor shall abridge the right of any beneficiary hereunder, whose claim may be unsatisfied.

IN WITNESS THEREOF, this instrument is executed in three (3) counterparts, each one of which shall be deemed an original, this day of _____, 20____.

ATTEST:

(Principal)

By: _____ (S)

(Address)

(SEAL)

Witness as to Principal

(Address)

(Surety)

ATTEST:

By: _____
Attorney-in-Fact

(Surety) Secretary

(Address)

(SEAL)

Witness as to Principal

(Address)

NOTE: Date of Bond must not be prior to date of Contract.

- (1) If Contractor is a Partnership, all partners should execute bond.

(NOTE TO SURETY COMPANY: A certified copy of unrevoked resolution of authority for the attorney-in-fact must be submitted with and attached to the executed bond.)

MAINTENANCE BOND

(NOTE: The Contractor must use this form. Use of any other bond form may prevent release of final payment and/or release of retention under the Contract)

KNOW ALL MEN BY THESE PRESENTS:

WHEREAS the City Council of the City of Sebastopol has awarded to _____, (designated as the "PRINCIPAL") a contract for the AMERICORPS TRAIL AND ZIMPHER CREEK BRIDGE CROSSING Project, which contract and all of the contract documents as defined therein (designated as the "Contract") are hereby made a part hereof; and

WHEREAS, the PRINCIPAL is required under the terms of the Contract to furnish a bond for the correction of any defects due to defective materials or workmanship in the work performed under the Contract.

NOW, THEREFORE, we the PRINCIPAL and the undersigned _____, as surety (designated as "SURETY"), an admitted surety insurer authorized to do business in the State of California, are held and firmly bound unto the City of Sebastopol, (designated as the "OBLIGEE"), in the penal sum of _____ Dollars (\$ _____), lawful money of the United States, being a sum not less than ten percent (10%) of the final Contract price, for the payment of which sum well and truly to be made, we bind ourselves, our heirs, executors, administrators, successors, and assigns jointly and severally, firmly by these presents.

THE CONDITIONS OF THIS OBLIGATION ARE SUCH that if, during a maintenance period of one (1) year from the date of acceptance by the OBLIGEE of the contracted work, the PRINCIPAL upon receiving written notice of a need for repairs which are directly attributable to defective materials or workmanship, shall diligently take the necessary steps to correct said defects within seven (7) days from the date of said notice, then this obligation shall be null and void; otherwise it shall remain in full force and effect.

If any action shall be brought by the OBLIGEE upon this bond, a reasonable attorney's fee, to be fixed by the Court, shall be and become a part of OBLIGEE's judgment in any such action. No right of action shall accrue on this bond to, or for the use of, any person or corporation other than the OBLIGEE named herein or the heirs, executors, administrator or successor of the OBLIGEE.

IN WITNESS WHEREOF, the above bound parties have executed this instrument under their seals this _____ day of _____, the name and corporate seals of each corporate party being hereto affixed and these presents duly signed by its undersigned representative, pursuant to authority of its governing body.

(Corporate Seal)

1. PRINCIPAL _____
2. By _____

(Acknowledgment) Title _____
SURETY _____

(Corporate Seal)

By _____
(Attorneys-in-fact)

(Acknowledgment) Title _____

(NOTE TO SURETY COMPANY: A certified copy of unrevoked resolution of authority for the attorney-in-fact must be submitted with and attached to the executed bond.)

ESCROW AGREEMENT

SECURITY DEPOSITS IN LIEU OF RETENTION

This Escrow Agreement is made and entered into by and between the City of Sebastopol, whose address is 7120 Bodega Avenue, P.O. Box 1776, Sebastopol, California 95473, hereinafter called "City", _____, whose address is _____, hereinafter called "Contractor", and _____, whose address is _____, hereinafter called "Escrow Agent"

For consideration hereinafter set forth, the City, Contractor, and Escrow Agent agree as follows:

1. Pursuant to Section 22300 of the Public Contract Code of the State of California, Contractor has the option to deposit securities with Escrow Agent as a substitute for retention earnings required to be withheld by City pursuant to the Construction Contract entered into between the City and Contractor for the project entitled AMERICORPS TRAIL AND ZIMPHER CREEK BRIDGE CROSSING in the amount of _____ dated _____ (hereinafter referred to as the "Contract"). Alternatively, on written request of the Contractor, the City shall make payments of the retention earnings directly to the Escrow Agent. When Contractor deposits the securities as substitute for Contract earnings, the Escrow Agent shall notify the City within 10 days of the deposit. The market value of the securities at the time of the substitution shall be at least equal to the cash amount then required to be withheld as retention under the terms of the Contract between the City and Contractor. Securities shall be held in the name of City of Sebastopol and shall designate the Contractor as the beneficial owner.
2. The City shall make progress payments to the Contractor for such funds which otherwise would be withheld from progress payments pursuant to the Contract provisions, provided that the Escrow Agent holds securities in the form and amount specified above.
3. When the City makes payment of retentions earned directly to the Escrow Agent, the Escrow Agent shall hold them for the benefit of the Contractor until such time as the escrow created under this contract is terminated. The Contractor may direct the investments of the payments into securities. All terms and conditions of this agreement and the rights and responsibilities of the parties shall be equally applicable and binding when the City pays the escrow agent directly.
4. Contractor shall be responsible for paying all fees for the expenses incurred by Escrow Agent in administering the Escrow Account and all expenses of the City. These expenses and payment terms shall be determined by the City, Contractor, and Escrow Agent.
5. The interest earned on the securities, or the money market accounts held in escrow and all interest earned on that interest shall be for the sole account of the Contractor and shall be subject to withdrawal by Contractor at any time and from time to time without notice to the City.
6. Contractor shall have the right to withdraw all or any part of the principal in the Escrow Account only by written notice to Escrow Agent accompanied by written authorization from City to the Escrow Agent that City consents to the withdrawal of the amount sought to be withdrawn by Contractor.
7. The City shall have a right to draw upon the securities in the event of default by the Contractor. Upon seven day's written notice to the Escrow Agent from the City of the default, the Escrow

Agent shall immediately convert the securities to cash and shall distribute the cash as instructed by the City.

8. Upon receipt of written notification from the City certifying that the Contract is final and complete, and that the Contractor has complied with all requirements and procedures applicable to the Contract, Escrow Agent shall release to Contractor all securities and interest on deposit less escrow fees and charges of the Escrow Account. The escrow shall be closed immediately upon disbursement of all monies and securities on deposit and payments of fees and charges.

9. Escrow Agent shall rely on the written notifications from the City and the Contractor pursuant to Sections (5) to (8) inclusive, of this agreement and the City and Contractor shall hold Escrow Agent harmless from Escrow Agent's release and disbursement of the securities and interest as set forth above.

10. The names of the persons who are authorized to give written notice or to receive written notice on behalf of the City and on behalf of Contractor in connection with the foregoing, and exemplars of their respective signatures, are as follows:

On Behalf of City:

On Behalf of Contractor

Title

Name

Title

Name

On Behalf of Escrow Agent:

Title

Name

Signature

Address

At the time the Escrow Account is opened, the City and Contractor shall deliver to the Escrow Agent a fully executed counterpart of this Agreement.

IN WITNESS WHEREOF, the parties have executed this Agreement by their proper officers on the date first set forth above.

City:

Contractor:

Title

Title

Name

Name

Signature

Signature

Address

Address

DRAFT

CONTRACT

PART 2 – GENERAL PROVISIONS

SECTION 1 Definitions

The following terms as used in any agreement of which these General Provisions are a part are defined as follows:

- 1-1.01 Contract:** The agreement between the City and Contractor concerning the Project, as evidenced by and comprised of the Contract Documents.
- 1-1.02 ASTM:** American Society for Testing and Materials latest edition.
- 1-1.04 Bid Package:** All of the documents listed as comprising the entire Bid Package as specified in the Information for Bidders and representing the full set of documents made available to bidders on the Project.
- 1-1.05 City:** City of Sebastopol
- 1-1.06 Public Works Standard Specifications and Details:** The City of Sebastopol Standard Details and Specifications, latest edition as approved on September 1, 1998.
- 1-1.07 Contract Documents:** All those documents listed in the Contract as comprising the entire agreement between the City and the Contractor.
- 1-1.08 Contractor:** The successful bidder for the Project and party to the Contract with the City as specified in the Contract Documents.
- 1-1.09 Days:** Unless otherwise specified in the Contract Documents, days mean working days.
- 1-1.10 Engineer:** The City's authorized representative for administration and overall management of the Project, Contract, and Work. The Engineer is the official point of contact between the City and the Contractor.
- 1-1.11 Project:** The AMERICORPS TRAIL AND ZIMPHER CREEK BRIDGE CROSSING Project as described in the Special Provisions and Project Plans.
- 1-1.12 Project Plans:** The primarily graphic detailed requirements concerning the Project contained in the Bid Package and any addenda to the Project Plans signed by authorized City representatives and issued prior to bid opening, Equal Product Proposals accepted by the City and signed by authorized City representatives prior to bid opening, and change orders and other amendments to the Project Plans signed by authorized representatives of the City and the Contractor in accordance with the requirements of the Contract Documents.
- 1-1.13 Project Inspector:** The party or parties charged by the City with inspecting the Work for compliance with the requirements of the Contract Documents and applicable laws and

regulations. The Project Inspector acts under the direction of the City and must coordinate with the Engineer as directed by the City in accordance with the Contract Documents.

- 1-1.14 Caltrans Standard Specifications:** The State of California Department of Transportation Standard Specifications 2018 edition.
- 1-1.15 Caltrans Construction Manual:** The State of California Department of Transportation Construction Manual, latest edition
- 1-1.16 Subcontractor:** A person, firm or corporation that is obligated as a party to a contract with the Contractor to perform part of the Work. For purposes of these General Provisions Subcontractors include, but are not limited to, those that are obligated as parties to a contract with the Contractor to specially fabricate and install a portion of the Work according to the Special Provisions and/or Project Plans.
- 1-1.17 Special Provisions:** The detailed Project requirements contained in the Bid Package and any addenda to the Special Provisions signed by authorized City representatives and issued prior to bid opening, Equal Product Proposals accepted by the City and signed by authorized City representatives prior to bid opening, and change orders and other amendments to the Special Provisions signed by authorized representatives of the City and the Contractor in accordance with the requirements of the Contract Documents.
- 1-1.18 Work:** The furnishing of all equipment, tools, apparatus, facilities, material, labor and skill necessary to perform and complete in a good and workmanlike manner the Project as shown in the City Special Provisions and Project Plans in accordance with the Contract Documents and applicable law.
- 1-1.19 Written Notice:** Will be deemed to have been duly served for purposes of these General Provisions and any Contract of which they are a part if delivered in person to the individual or to a member of the firm or to any office of the corporation for whom the notice is intended, or if sent by registered or certified mail to the last known business address known to the party giving notice. Unless otherwise specified in the Contract Documents, the last known address of the Contractor will be that listed in the Contractor's completed Proposal.

SECTION 2 Scope of Work

2-1.01 Documents Furnished by City. The City will furnish to the Contractor, free of charge, five (5) sets of prints of the Project Plans and Special Provisions for execution of the Work. Throughout the performance of the Work the Contractor must keep one copy of the Project Plans and Special Provisions in good order and available for review by the Engineer, and any other City contractors or representatives.

2-1.02 Ownership of Documents Furnished by City. All documents furnished by the City, including, but not limited to, the Special Provisions, Project Plans, and any copies, are the property of the City. Documents furnished by the City may not be used on any other work. All documents furnished by the City must be returned to City upon completion of the Work.

2-1.03 Special Provisions and Project Plans.

- a. The Special Provisions and Project Plans are complementary and intended to mutually describe the Work necessary to complete the Project in accordance with the Contract Documents.
- b. In general, the Project Plans indicate dimensions, position and kind of construction, and the Special Provisions indicate qualities and methods. Any Work indicated on the Project Plans and not mentioned in the Special Provisions or vice versa must be furnished as though fully set forth in both. Work that is not particularly detailed, marked or specified will be the same as similar Work that is detailed, marked or specified. The Contractor must furnish items necessary for the operation of equipment depicted in the Project Plans or specified in the Special Provisions that are suitable to allow such equipment to function properly at no extra charge.
- c. The Contractor must notify the Engineer as soon as possible of any apparent errors or inconsistencies, including, but not limited to, typographical or notational errors in the Project Plans, Special Provisions, and/or in work done by others affecting the Work. The Engineer will issue instructions concerning any such apparent errors or inconsistencies. If the Contractor proceeds with Work impacted by apparent errors or inconsistencies without instructions from the Engineer, the Contractor does so at its sole risk and will have all of the obligations and the City will have all of the rights and remedies specified in Section 11 concerning any resulting damage or defect.
- d. The General Provisions apply with equal force to all of the Work, including extra work authorized by the Engineer in accordance with the Contract Documents. The Contractor must submit any required shop diagrams and/or drawings by the times and in the quantities indicated in the Special Provisions. Any such shop diagrams and/or drawings must show completely the Work to be done, expanding on the Project Plans concerning details not previously shown, field conditions and the condition of the Work. Engineer review of such shop diagrams and/or drawings will concern conformance with the requirements of the Contract Documents only. The Engineer assumes no responsibility for the correctness or accuracy of the dimensions or any other contents of any shop diagrams and/or drawings submitted by the Contractor. The Contractor must check all dimensions at the Work site. Shop diagrams and/or drawings must be clearly marked with the name of the Project and the name of the Contractor, subcontractor or supplier making the submittal, and must be stamped and signed by

the Contractor and submitted under a signed transmittal letter from the Contractor certifying that all dimensions have been checked at the Work site. These requirements are mandatory. The Engineer will not review shop diagrams and/or drawings that do not satisfy these requirements. The Contractor will be responsible for any and all discrepancies between dimensions of the actual Work site and/or Work and those shown on shop diagram and/or drawings submitted by the Contractor, and for any other errors contained in or resulting from such shop diagrams and/or drawings, including, but not limited to, errors in material and/or equipment quantities and any resulting errors, delays or additional cost in the performance of the Work. The Contractor will have all of the obligations and the City will have all of the rights and remedies that are specified in Section 11 concerning any discrepancies or errors in shop diagrams and/or drawings submitted by the Contractor, and concerning any resulting errors, delays or additional costs in the performance of the Work.

DRAFT

SECTION 3 Control of Work and Material

3-1.01 Engineer's Status. The Engineer will administer the Project in accordance with the Contract Documents. After execution of the Contract and issuance of the Notice to Proceed, all correspondence and/or instructions concerning the Project between the Contractor and/or City must be forwarded through the Engineer. Except as otherwise provided in the Contract Documents, the Engineer will not be responsible for and will not have control or charge of construction means, methods, techniques, or procedures or for safety precautions in connection with the Work. The Engineer, however, will have authority to reject materials and/or workmanship that do not conform to the requirements of the Contract Documents. The Engineer will also have the authority to require inspection or testing of the Work.

3-1.02 Inspection and Testing of Work and Material.

- a. The City, the Engineer and their representatives will have access to the Work at all times wherever it is in preparation or progress. The Contractor must provide proper facilities for such access and for inspection.
- b. The Contractor must inspect all materials as delivered and promptly return all defective materials without waiting for their rejection by the Engineer.
- c. If the Engineer, the Special Provisions, or any laws, ordinances, or any public authority require any Work to be tested or approved, the Contractor must give the Engineer timely notice of the Contractor's readiness for inspection. Inspections will be promptly made, and where practicable, at the source of supply. Any Work subject to such testing that is covered up without timely notice to the Engineer or without the approval or consent of the Engineer must, if required by the Engineer, be uncovered for examination at the Contractor's expense. The Contractor will have all of the obligations and the City will have all of the rights and remedies that are specified in Section 11 concerning any Work subject to testing that is covered up or otherwise rendered inaccessible for inspection without timely notice to the Engineer and that is not uncovered for examination at the Contractor's expense if required by the Engineer.
- d. Tests of materials or qualification tests required by the Contract Documents must be made in accordance with the Special Provisions and the requirements of the California Building Standards Code as adopted by the City and other applicable law. Copies of all testing reports will be distributed as required in the Special Provisions.
- e. The City or its representatives may order re-examination of questioned Work. If ordered to do so, the Contractor must uncover such Work. If such Work is found to be according to the Contract Documents, the City will pay the cost of uncovering and restoring the Work, unless such Work was subject to testing and covered up without timely notice to or approval of the Engineer. If re-examined Work is found not in accordance with the Contract Documents, the Contractor must pay the cost of uncovering and restoring the Work. The Contractor will have all of the obligations and the City will have all of the rights and remedies that are specified in Section 11 concerning any re-examined Work not in accordance with the Contract Documents that the Contractor fails to uncover and restore at the Contractor's expense.

- f. The Contractor must replace or correct without charge any material or workmanship found not to conform to the requirements of the Contract Documents, unless the City consents to accept such material or workmanship with an appropriate adjustment in the Contract Price. The Contractor must promptly segregate and remove non-conforming material from the Work site. The Contractor will have all of the obligations and the City will have all of the rights and remedies that are specified in Section 11 concerning any failure by the Contractor to replace or correct without charge any material or workmanship that does not conform to the requirements of the Contract Documents and that the City has not consented to accept.

3-1.03 Samples Furnished by the Contractor. The Contractor must furnish all samples for approval as directed in sufficient time to permit the Engineer to examine, approve and select samples before they are required by the progress of the Work. Portions of the Work for which samples are required and for which the Engineer has selected samples must be in accordance with such approved samples. Samples must be sent prepaid to the office of the Engineer or to such place as the Engineer may direct.

3-1.04 Materials and Substitutions.

- a. Materials used for the Work must be new and of the quality specified. When not particularly specified, materials must be the best of their class or kind. The Contractor must, if required, submit satisfactory evidence as to the kind and quality of materials.
- b. If the Contractor submitted complete information to the City Engineer for products proposed as equals in accordance with the bid package, and the City approved such products proposed as equals in writing, the Contractor may either furnish such products approved as equals, or furnish the products listed by manufacturer name, brand or model number in the Special Provisions or Project Plans. The City retains the right, in its sole discretion, to accept or reject any other proposed substitution. To be considered, proposals concerning products proposed as equals must include sufficient information to permit the City to determine whether the products proposed as equals will satisfy the same performance requirements as products listed by manufacturer's name, brand or model number. Such performance requirements may include, but are not limited to, size, strength, function, and appearance, ease of maintenance and repair, and useful life requirements. If the City does not accept a proposed substitution, the Contractor must furnish the product specified in the Special Provisions or Project Plans for the Contract Price, regardless of whether the product is specified by manufacturer's name, brand or model number, or otherwise.
- c. During the performance of the Work, all materials must be neatly stacked, properly protected from the weather and other adverse impacts, and placed so as to avoid interference with efficient progress of the Work, with other activities of the City, or with the use of existing City facilities by the public. Materials may not be stored in a manner that presents a safety hazard or a nuisance. All materials must be delivered so as to ensure efficient and uninterrupted progress of the Work. Materials must be stored so as to cause no obstruction and so as to prevent overloading of any portion of the Work. The Contractor will be responsible for damage or loss of materials delivered to and/or stored at the Work site due to weather or other causes. The Contractor must promptly remove from the Work site all materials rejected by the City or its representatives as

- failing to conform to the requirements of the Contract Documents, whether such non-conforming materials have been incorporated in the Work or not. If the City or its representatives so direct, the Contractor must promptly replace and re-execute Work performed by the Contractor and order the replacement and re-execution of Work performed by subcontractors using non-conforming materials with materials that satisfy the requirements of the Contract Documents without expense to the City. The Contractor will bear the expense of making good all Work destroyed or damaged by such removal. The Contractor will have all of the obligations and the City will have all of the rights and remedies that are specified in Section 11 concerning any failure by the Contractor to replace or re-execute Work using non-conforming materials, and/or to make good all Work destroyed or damaged by such removal and/or execution.
- d. If any portion of the Work done or material furnished under this Contract proves defective and not in accordance with the Project Plans or Special Provisions, and if the Engineer determines that the imperfection of the same is not of sufficient magnitude or importance to make the Work dangerous or undesirable, or if the removal of such Work, is impractical or will create conditions which are dangerous or undesirable, the Engineer may retain such Work, instead of requiring the imperfect Work to be removed and reconstructed, and make such deductions therefore in the payments due or to become due the Contractor as are just and reasonable.

3-1.05 Audit and Examination of Records. The City may examine and audit at no additional cost to the City all books, estimates, records, contracts, documents, bid documents, bid cost data, subcontract job cost reports and other Project related data of the Contractor, subcontractors engaged in performance of the Work, and suppliers providing supplies, equipment and other materials required for the Work, including computations and projections related to bidding, negotiating, pricing or performing the Work or Contract modifications and other materials concerning the Work, including, but not limited to, Contractor daily logs, in order to evaluate the accuracy, completeness, and currency of cost, pricing, scheduling and any other Project related data. The Contractor will make available all such Project related data at all reasonable times for examination, audit, or reproduction at the Contractor's business office at or near the Work site, and at any other location where such Project related data may be kept until three years after final payment under the Contract. Pursuant to California Government Code Section 8546.7, if the amount of public funds to be expended is in excess of \$10,000, this Contract will be subject to the examination and audit of the State Auditor, at the request of the City, or as part of any audit of the City, for a period of three (3) years after final payment under the Contract.

3-1.06 Advertising. No advertising signs of any kind may be displayed on the Work site, or on fences, offices or elsewhere adjacent to the Work site.

3-1.07 Project Schedule. Within ten (10) days after execution and delivery of the Contract, and prior to the issuance of the notice to proceed, the Contractor must deliver to the Engineer a bar chart and critical path (CPM) schedule detailing the Contractor's intended schedule of Work for the entire Project. The schedules must be detailed to clearly show the relative sequence of the items of Work, their inter-relationships, start and completion dates, float, the critical path, and any other item deemed necessary by the Engineer. The schedule must allow for the completion of the entire Work within the Time for Completion.

- a. City Review of Schedule. The City may review the Contractor's submitted schedule and may note any exceptions. The Contractor must correct any exceptions noted by the City within five (5) working days of being notified of the exceptions.
- b. Update of Schedule. After submission of a schedule to which the City has taken no exceptions, the Contractor must submit an updated schedule on a monthly basis or as otherwise specified by the City until completion of the Work. The updated schedule must show the progress of Work as of the date specified in the updated schedule.
- c. Float. The schedule must show early and late completion dates for each task. The number of days between these dates will be designated as "Float". The Float will be designated to the Project and will be available to both the City and the Contractor as needed to complete the Work in accordance with the Contract.
- d. Failure to Submit Schedule. If the Contractor fails to submit schedules within the time periods specified in this Section or submits a schedule to which the City has taken uncorrected exceptions, the City may withhold payments to the Contractor until such schedules are submitted and/or corrected in accordance with the Contract Documents.
- e. Responsibility for Schedule. The Contractor will be solely and exclusively responsible for creating the schedule and properly updating it. The City may note exceptions to any schedule submitted by the Contractor. However, the Contractor will be solely responsible for determining the proper method for addressing such exceptions and the City's review of the schedule will not create scheduling obligations of the City.

3-1.08 Construction Staking. All Work done under this Contract must be in conformance with the Project Plans and contract documents. It is the responsibility of the Contractor to obtain construction staking services. The Contractor must inform the Engineer, forty-eight (48) hours in advance if electronic design files or other information is needed to be transmitted to a surveyor, in order that lines and grades may be furnished and necessary measurements for record and payment made, with the minimum of inconvenience to the Engineer and delay to the Contractor.

The City will **NOT** provide construction staking services.

The Contractor shall carefully preserve bench marks, reference points, and stakes and in the case of willful or careless destruction, will be responsible for the cost of replacement and shall be responsible for any mistakes that may be caused by their unnecessary loss or disturbance

3-1.09 Materials Testing. Materials will be tested by the City of Sebastopol or its authorized agent, following the Caltrans Standard Specifications. Statistical testing may not be used. All individual samples must meet the specified test results. Each material used must meet the specified requirements.

The Contractor must request and coordinate all testing. All tests must occur in the presence of the Project Inspector. The City will, at its sole discretion, have the right to reject any and/or all test results, that do not meet this requirement, and to order a retest

in the presence of the Project Inspector. The costs for all retests so ordered will be the responsibility of the Contractor. The cost of all retests will be charged to the Contractor at the actual cost plus 30 percent, with a minimum charge of \$150.00 per test to cover staff and administrative costs.

The City, at its sole expense, will provide all initial material and compaction tests. Sampling and testing will comply with Chapter 3 of the Caltrans Construction Manual at a minimum. Where conditions vary, the City may perform additional testing. Cost for testing of materials offered in lieu of the specified materials will be the responsibility of the Contractor. Cost for R-value tests when required by the Caltrans Standard Specifications will be the responsibility of the Contractor.

Testing will only be performed on normal City working days between the hours of 8:00 a.m. and 4:00 p.m. unless other arrangements are made in advance. Tests performed outside of these hours may be subject to increased charges.

The Contractor must request all tests in writing a minimum of 2 working days in advance of the time desired. A minimum of one working day must be allowed for compilation and reporting of data and test results after tests have been performed. No subsequent layer of material may be placed until a passing test is obtained and acknowledged by the City.

Concrete and asphalt may be supplied only from suppliers approved and certified by the State Department of Transportation. Proposed mix designs for all concrete and asphalt concrete to be placed within the City of Sebastopol must be provided to and approved by the City, prior to placement.

The Contractor must coordinate with the City concerning any additional testing as required.

SECTION 4 Changes in Work

4-1.01 City Directed Change Orders. The City may at any time during the progress of the Work direct any amendments to the Work or any of the Contract Documents, including, but not limited to the Special Provisions, or Project Plans. Such amendments will in no way void the Contract, but will be applied to amend the Contract Price, if such amendments affect the Contract Price, the Project schedule, if such amendments affect the Project schedule, or any other provision of the Contract Documents based on a fair and reasonable valuation of the amendment in accordance with this Section 4.

4-1.02 Writing Requirement. Change orders and other amendments to the Special Provisions, the Project Plans, or other Contract Documents may be made only upon prior written approval of the Engineer and as evidenced by a writing executed by authorized representatives of the City and the Contractor.

4-1.03 Contractor Proposed Change Orders. Unless the Engineer otherwise authorizes or the City and the Contractor otherwise agree, change order proposals submitted by the Contractor must be submitted to the Engineer no later than the time of the proposed change.

4-1.04 All Change Orders. All change order proposals must be submitted on completed City Change Order forms. All such change order proposals must itemize all cost impacts of the proposed change order and include a total price for that change order and the amended Contract Price that would become effective upon execution of the change order. All change order proposals must specify any change in the Project schedule, or in any Project milestone including, but not limited to, the Time for Completion, under the change order. It is understood that change orders that do not specify a change in any milestone, including, but not limited to, the Time for Completion, may be accomplished by the Time for Completion then in effect.

4-1.05 Change Order Pricing. Change order pricing for all change orders, whether, additive, deductive, or both, will be governed by the following:

- a. Prices specified in the Contract Documents will apply to cost impacts involving items for which the Contract Documents specify prices.
- b. Cost impacts involving items for which the Contract Documents do not specify prices may be paid on a lump sum basis as approved by the City.
- c. For cost impacts involving items for which the Contract Documents do not specify prices, and for which no lump sum amount has been approved by the City, charges or credits for the Work will be paid on a time and materials basis in accordance with the following and subject to Caltrans Standard Specifications, provision 9-1.03 concerning allowable direct charges. The time and materials payment will be the sum of and limited to the direct and indirect costs for labor, materials, equipment and overhead calculated as follows:
 1. Labor: The Contractor will be paid the cost of labor for the workers (including foremen when authorized by the Engineer), used in the actual and direct performance of the Work. The cost of labor utilized in performing the Work,

whether the employer is the Contractor, a subcontractor or other entity engaged in the performance of the Work, will be the sum of the following:

- a. **Actual Wages:** The actual wages paid will include any employer fringe benefit payments to or on behalf of the workers for health and welfare, pension, vacation and similar purposes. The actual wages and fringe benefits paid must be at the rates shown on the certified payroll documents submitted by the Contractor.
 - b. **Labor Surcharge:** The labor surcharge will be as set forth in the latest edition of the California Department of Transportation publication entitled "Labor Surcharge and Equipment Rental Rates". The labor surcharge will constitute full compensation for all payments imposed by State or Federal laws and for all other payments made to, or on behalf of, workers engaged in the performance of the Work, excluding the Actual Wages as defined above.
 - c. **Fixed Markup:** A fixed markup of 15% of the sum of the actual wages paid and the labor surcharge applicable to such actual wages, together with the actual wage and labor surcharge costs described in this provision will constitute full and complete compensation for all overhead, profit, incidentals, and any and all other direct or indirect expenses associated with furnishing all labor for the Work.
2. **Materials:** Materials costs will be the direct costs for materials actually exhausted, consumed or entering permanently into the Work, plus a fixed markup of 15% of such direct materials costs, which, together with the direct cost of materials as described in this provision will constitute full and complete compensation for all overhead, profit, incidentals, and any and all other direct or indirect expenses associated with furnishing all materials for the Work.
 3. **Equipment:** All equipment used will be paid in accordance with the rates in subsection 9-1.04D entitled "Equipment Rental" of the Caltrans Standard Specifications, which subsection 9-1.04D is made a part of this Contract, plus a fixed markup of 10% of such equipment rates, which, together with the equipment rates as described in this provision will constitute full and complete compensation for all overhead, profit, incidentals, and any and all other direct or indirect expenses associated with furnishing all equipment for the Work.
 4. Unless approved in writing in accordance with provision 4-1.02 of this Contract in advance of performance of the Work, any and all other cost impacts (including, but not limited to profit, bond premiums or fees, insurance premiums or fees, superintendent labor, clerical expenses, home office expenses, Work site office expenses, utility costs, permit costs, and licensing costs) involving items for which the Contract Documents do not specify prices, and for which no lump sum amount has been approved by the City, will constitute incidentals, full compensation for which will be deemed included in the markups for labor, material, and equipment specified above, and no additional compensation for such cost impacts will be allowed.

4-1.06 Liability Under Unapproved Change Orders. The Contractor will be solely responsible for any and all losses, costs, or liabilities of any kind incurred by the Contractor, any subcontractor engaged in the performance of the Work, any party supplying material or equipment for the Work or any third party that are incurred pursuant to Contractor-proposed change orders prior to issuance of an approved change order executed in accordance with this Section 4. The Contractor will have all of the obligations and the City will have all of the rights and remedies that are specified in Section 11 concerning any work or resulting losses, costs, or liabilities pursuant to a Contractor proposed change order before issuance of an approved change order executed in accordance with this Section 4.

4-1.07 Changes Subject to Contract Documents. Any changes in the Work and/or the Contract Documents pursuant to change orders and any other amendments issued in accordance with the Contract Documents, including this Section 4, will in all respects be subject to all provisions of the Contract Documents, including, but not limited to, the Special Provisions and the Project Plans, except as modified by such change orders or amendments.

4-1.08 Change Order Disputes.

- a. Disputed City-Directed Change Orders. If the Contractor disputes a City directed change order following a reasonable effort by the City and the Contractor to resolve the dispute including, at a minimum, a meeting between appropriate representatives of the Contractor and the City, the Contractor must commence performing the Work consistent with the disputed change order within five (5) working days of the last meeting between representatives of the Contractor and the City to resolve the dispute, or within the time specified in the disputed City directed change order, whichever is later. In performing Work consistent with a disputed City-directed change order pursuant to this provision the Contractor will have all of the Contractor's rights concerning claims pursuant to the Contract Documents and applicable law.
- b. Disputed Contractor Proposed Change Orders. If the City disputes a Contractor proposed change order, the City and the Contractor will use reasonable efforts to resolve the dispute including, at a minimum, holding a meeting between appropriate representatives of the Contractor and the City. Regardless of and throughout any such efforts to resolve the dispute the Contractor must continue performing the Work irrespective of and unmodified by the disputed change order. In continuing to perform the Work, the Contractor will retain all of the Contractor's rights under contract or law pertaining to resolution of disputes and protests between contracting parties. Disputes between the City and the Contractor concerning any Contractor-proposed change order or other amendment do not excuse the Contractor's obligation to perform the Work in accordance with the Contract Documents excluding such Contractor-proposed change order or other amendment by the Time for Completion or waive any other Project milestone or other requirement of the Contract Documents.

SECTION 5 Trenching and Utilities

5-1.01 Excavation More Than Four Feet Deep. In accordance with California Public Contract Code Section 7104, if the Work involves excavation more than four feet deep the Contractor must promptly notify the City in writing before disturbing: any material that the Contractor believes may be hazardous waste, as defined in Section 25117 of the Health and Safety Code, that is required to be removed to a Class I, Class II or Class III disposal site in accordance with provisions of existing law; any subsurface or latent physical conditions at the Work site differing from those indicated; or any unknown physical conditions at the Work site of any unusual nature, different materially from those ordinarily encountered and generally recognized as inherent in work of the character provided for in the Contract Documents. The City will promptly investigate any such conditions for which notice is given. If the City finds that the conditions do materially differ, or involve hazardous waste, and would cause a decrease or increase in the cost or time of performance of the Work, the City will issue a change order pursuant to Section 4 of these General Provisions. If a dispute arises between the City and the Contractor concerning whether the conditions materially differ, or involve hazardous waste, or cause a decrease of increase in the cost or time of performance, the Contractor will not be excused from any completion date provided in the Contract Documents, but will proceed with all Work to be performed. The Contractor will retain all rights under contract or law pertaining to resolution of disputes and protests between contracting parties.

5-1.02 Excavation of Five Feet or More. In accordance with California Labor Code Section 6705, contractors performing contracts exceeding \$25,000 in cost and involving excavation five or more feet deep must submit for the City's acceptance, prior to excavation, a detailed plan showing the design of shoring, bracing, sloping, or other provisions to be made for worker protection from the hazard of caving ground during excavation. If the plan varies from the shoring system standards, it must be prepared by a registered civil or structural engineer.

5-1.03 Utility Relocation Costs.

- a. In accordance with California Government Code Section 4215, the City assumes the responsibility for the timely removal, relocation or protection of existing main or trunk line utility facilities located on the Work site if such utilities are not identified by the City in the Special Provisions and/or Project Plans. The City will compensate the Contractor for the costs of locating, repairing damage not due to the Contractor's failure to exercise reasonable care, and removing or relocating existing main or trunk line utility facilities located at the Work site and not identified with reasonable accuracy in the Special Provisions and/or Project Plans. The City will also compensate the Contractor for the cost of equipment on the Project necessarily idled during such work. The Contractor will not be assessed liquidated damages for Work completion delays caused by the City's failure to provide for removal or relocation of such main or trunk line utility facilities.
- b. Nothing in this provision or the Contract Documents will be deemed to require the City to indicate the presence of existing service laterals or appurtenances whenever the presence of such utilities on the Work site can be inferred from the presence of other visible facilities, such as buildings, meter and junction boxes, cleanouts, on or adjacent to the Work site; provided, however, that nothing in this provision or the Contract

Documents will relieve the City from identifying main or trunk lines in the Special Provisions and/or Project Plans.

- c. Nothing in this provision or the Contract Documents will preclude the City from pursuing any appropriate remedy against the utility for delays, which are the responsibility of the utility.
- d. Nothing in this provision or the Contract Documents will be construed to relieve the utility from any obligation as required either by law or by contract to pay the cost of removal or relocation of existing utility facilities.
- e. If the Contractor while performing the Work discovers utility facilities not identified by the City in the Special Provisions and/or Project Plans, the Contractor must immediately notify the City and utility in writing.
- f. Either the City or the utility, whichever owns existing main or trunk line utility facilities located on the Work site, will have sole discretion to effect repairs or relocation work or to permit the Contractor to perform such repairs or relocation work at a reasonable price.

5-1.04 Protection of Existing Facilities and Property.

The Contractor must notify Underground Service Alert (USA) for marking the locations of existing underground facilities.

The Contractor must take all necessary measures to avoid injury to existing surface and underground utility facilities in and near the Work site. No error or omission of utility markouts will be construed to relieve the Contractor from his responsibility to protect all underground pipes, conduits, cables or other structures affected by the work.

The existing underground facilities in the area of Work may include telephone, television and electrical cables, gas mains, water mains, sewer pipe and drainage pipe. The various utility companies must be notified before trenching begins and at such other times as required to protect their facilities. All underground facilities must be located and exposed ahead of trenching to prevent damage to the facilities, and to determine the depth and character of all facilities that cross or infringe on the trench prism. The Contractor must immediately notify the Engineer of any facilities found. If damage should occur to the existing facilities, the utility company and the City must be notified immediately and, repairs acceptable to the utility company must be made at the Contractor's expense.

The Project Plans show the underground utilities on the site of the construction insofar as they are known to the City. The drawings may not show facilities apparent from visual inspection of the site or service laterals or appurtenances, the existence of which can be inferred from the presence of other visible facilities such as buildings, meters, junction boxes, etc. on or adjacent to the construction site.

If in the performance of the Work an existing utility is encountered that is not shown on the Project Plans and is not apparent or inferable from visual inspection of the Work site, the Inspector must be notified immediately. The Engineer will determine, whether the

Project Plans or Special Provisions should be modified, or whether the existing utility should be relocated or whether the Contractor must work around the existing utility. The Contractor must replace, at his or her own expense, in as good condition as they were prior to the start of construction, all existing improvements and surroundings damaged by his or her operation. Reconstruction of all existing improvements must conform to Public Works Standard Specifications and Details under the direction of and subject to the acceptance by the Engineer.

Should the Contractor fail to take adequate measures to avoid injury or damage to the facilities described above, the City may take any actions necessary to protect such facilities from the Contractor's operations. Subject to Section 5 of the General Provisions, the City may withhold the cost of injury to existing surface and underground utility facilities in and near the Work site from amounts due or that may become due the Contractor.

DRAFT

SECTION 6 Project Facilities

6-1.01 Work Site Offices. Any Work site office facilities used by the Contractor and/or its privities must conform to all applicable codes, ordinances and regulations. The cost of such Work site office facilities will be paid from and included in the Contract Price.

6-1.02 City Rights of Access and Ownership. The City and its authorized representatives will at all reasonable times while such office facilities are located at the Work site (including, at a minimum, all times during which the Work is performed), have access to any such Work site office facilities used by the Contractor and/or its privities. With respect to the right of access of the City and its authorized representatives, neither the Contractor nor its privities will have a reasonable expectation of privacy pursuant to the Fourth Amendment to the Unites States Constitution or other applicable law concerning such Work site office facilities used by the Contractor and/or its privities. Without exception, any and all Project related materials located at such Work site facilities will be deemed at all times to be City property subject to inspection and copying by the City and its authorized representatives at all reasonable times while such facilities are located at the Work site (including, at a minimum, all times during which the Work is performed). Any interference by the Contractor or its privities with the City's rights of access and/or ownership pursuant to this Section 6 will constitute a material breach of the Contract subject to any and all remedies available pursuant to the Contract Documents and at law and equity.

DRAFT

SECTION 7 Prosecution and Progress of the Work

7-1.01 Liquidated Damages. For the purposes of this Contract time is of the essence. The City and the Contractor agree that it will be difficult and/or impossible to determine the actual damage which the City will sustain in the event of the Contractor's failure to fully perform the Work or to fully perform all of the Contractor's obligations that have accrued pursuant to the Contract by the Time for Completion. Accordingly, the City and the Contractor agree in accordance with California Government Code Section 53069.85 that the Contractor will forfeit and pay to the City liquidated damages in the sum of \$1000 per day for each and every calendar day completion of the Work and/or performance of all of the Contractor's obligations that have accrued pursuant to the Contract is delayed beyond the Time for Completion. The City and the Contractor further agree in accordance with California Government Code Section 53069.85 that the liquidated damages sum specified in this provision is not manifestly unreasonable under the circumstances existing at the time the Contract was made, and that the City may deduct liquidated damages sums in accordance with this provision from any payments due or that may become due the Contractor under the Contract.

7-1.02 No Damage for Avoidable Delays. All delays in the Work that might have been avoided by the exercise of care, prudence, foresight and diligence of the Contractor or any privities of the Contractor will be deemed avoidable delays. Delays in the Work that may be unavoidable but that do not necessarily affect other portions of the Work or prevent completion of all Work within the Time for Completion, including, but not limited to, reasonable delays in Engineer approval of shop drawings, placement of construction survey stakes, measurements and inspection, and such interruption as may occur in prosecution of the Work due to reasonable interference of other contractors of the City, will be deemed avoidable delays. The Contractor will not be awarded a change in the Project schedule, the Time for Completion, and/or additional compensation in excess of the contract price for avoidable delays.

7-1.03 Unavoidable Delays. All delays in the Work that result from causes beyond the control of the Contractor and that the Contractor could not have avoided through exercise of care, prudence, foresight, and diligence will be deemed unavoidable delays. Orders issued by the City changing the amount of Work to be done, the quantity of materials to be furnished, or the manner in which the work is to be prosecuted, and unforeseen delays in the prosecution of the Work due to causes beyond the Contractor's control, such as strikes, lockouts, labor disturbances, fires, epidemics, earthquakes, acts of God, neglect by utility owners or other contractors that are not privities of the Contractor will be deemed unavoidable delays to the extent they actually delay the Contractor's completion of the Work. The Contractor will be awarded a change in the Project schedule, the Time for Completion, and/or additional compensation in excess of the contract price for unavoidable delays to the extent such delays actually delay the Contractor's completion of the Work and/or result in the Contractor incurring additional costs in excess of the Contract Price.

Delay due to normal, adverse weather conditions will not be deemed unavoidable. The Contractor should understand that normal adverse weather conditions are to be expected and plan the Work accordingly, such as by incorporating into the Project schedule normal, adverse weather delays as reflected in historical data of the National Oceanic and

Atmospheric Administration of the U.S. Department of Commerce for the weather station most applicable to the Work site.

7-1.04 No Damage for Contractor Caused Delay. Contractor will not be entitled to additional compensation for extended field or home office overhead, field supervision, costs of capital, interest, escalation charges, acceleration costs or other impacts for any delays to the extent such delays are caused by the failure of the Contractor or any subcontractor or other entity engaged in performance of the Work to perform the Work in accordance with the Contract Documents.

7-1.05 No Damage for Delay Not Caused By the City, Delay Contemplated by the Parties, or other Reasonable Delay. Contractor will not be entitled to damages for delay to the Work caused by the following, which the City and Contractor agree will be deemed for purposes of California Public Contract Code Section 7102 either not caused by the City, and/or within the contemplation of the City and the Contractor, and/or reasonable under the circumstances:

- a. Exercise of the City's right to sequence the Work in a manner that would avoid disruption to the City and other contractors based on: the failure of the Contractor or any subcontractor or other entity engaged in the performance of the Work to perform the Work in accordance with the Contract Documents, enforcement by the City or any other governmental agency of competent jurisdiction of any government act or regulation, or enforcement by the City of any provisions of the Contract.
- b. Requests for clarification or information concerning the Contract Documents or proposed change orders or modifications to the Contract Documents, including extensive and/or numerous such requests for clarification or information or proposed change orders or modifications, provided such clarifications or information or proposed change orders or modifications are processed by the City or its representatives in a reasonable time in accordance with the Contract Documents.

7-1.06 Delays Caused by the City and/or It's Privities. Delay caused by the City and/or other contractors of the City will be deemed unavoidable delays. Either the City or the Contractor may propose a change in the Time for Completion and/or the Project schedule for delays that are purported to be caused by the City and/or its privities and that are not reasonable under the circumstances involved and/or that are not within the contemplation of the City and the Contractor. Such proposed changes in the Time for Completion will constitute change order proposals subject to Section 4. In accordance with Section 4, the City and the Contractor may agree upon pricing for the cost impacts, if any, resulting from such delays. If such pricing and/or changes in the Time for Completion and/or the Project schedule are in anticipation of impacts that may, but have not yet occurred, the City will be obligated to pay the Contractor for such anticipated impacts or to award a change in the Time for Completion and/or the Project schedule in accordance with the Contract and any applicable, approved change orders only to the extent the Contractor actually incurs the anticipated impacts. Notwithstanding anything to the contrary in Section 4, the City and the Contractor may agree to a daily rate or cap or lump sum that will apply to the cost impacts, if any, resulting from delay purportedly caused by the City and/or its privities subject to this provision. However, if such daily rate or cap or lump sum is in anticipation of cost impacts that have not yet occurred, the City will be obligated to pay such daily rate or cap or lump sum only to the extent the Contractor actually incurs such cost impacts.

7-1.07 Delay Claims. Whenever the Contractor claims a delay for which the Time for Completion may be extended, the Contractor must request an extension of time within five (5) days of the start of the delay. The request must be in writing and describe in detail the cause for the delay, and, if possible, the foreseeable extent of the delay.

7-1.08 Contractor Coordination of the Work.

- a. The City reserves the right to do other work in connection with or in the vicinity of the Project by contract or otherwise, and Contractor must at all times conduct the Work so as to impose no hardship on the City, others engaged in the Work or other contractors working at the Work site. The Contractor will adjust, correct and coordinate the Work with the work of others so that no delays result in the Work or other work at or near the Work site.
- b. If any part of the Work depends for proper execution or results upon the work of the City or any other contractor, the Contractor will, before proceeding with such Work, promptly report to the City any apparent discrepancies or defects in such other Work. Failure of the Contractor to promptly report any apparent discrepancy or defect will be deemed an acceptance of the City's or other contractor's Work as fit and proper.
- c. The Contractor will anticipate the relations of the various trades to the progress of the Work and will ensure that required anchorage or blocking is furnished and set at proper times. Anchorage and blocking necessary for each trade will be part of the Work except where stated otherwise.
- d. The Contractor will provide proper facilities at all times for access of the City, the Engineer and other authorized City representatives to conveniently examine and inspect the Work.

SECTION 8 Contractor Responsibilities

- 8-1.01 Eligibility.** By executing the Contract, the Contractor certifies that the Contractor is not ineligible to perform work on public works projects pursuant to California Labor Code Sections 1777.1 or 1777.7. In accordance with California Public Contract Code Section 6109(a), contractors who are ineligible to perform work on public works projects pursuant to California Labor Code Sections 1777.1 or 1777.7 may neither bid on, be awarded or perform the Work. To the full extent permitted by law the Contractor will hold harmless, indemnify and defend the City from and against any and all damages, costs, and liability arising from or as a consequence of any violation of Public Contract Code Section 6109.
- 8-1.02 Supervision of the Work.** The Contractor will be solely responsible for the performance of the Work, including portions of the Work to be performed by subcontractors. The Contractor is charged with ensuring that all orders or instructions from the City, Engineer are disseminated to and followed by all subcontractors engaged in performance of the Work. The Contractor will supervise the Work using the Contractor's best skill and attention. At any time during the progress of the Work, the City, the Engineer may require the Contractor and/or subcontractors engaged in performance of the Work to attend a Project meeting and the Contractor will attend, and ensure the attendance of any subcontractors whose attendance is required by the City and/or advisable in light of the matters to be addressed at the meeting.
- 8-1.03 Contractor's Superintendent.** The Contractor will keep on the Work, throughout its progress, a competent superintendent and any necessary assistants, all satisfactory to the City. The superintendent may not be changed without the consent of the City. The superintendent will represent the Contractor and all directions given by the City to the superintendent will bind the Contractor in accordance with the Contract. Superintendent time included in Contractor's completed bid schedule and/or in approved change orders, if any, must be included in Contractor's approved overhead rate and may not be charged as a direct cost.
- 8-1.04 Competent Employees.** The Contractor must at all times enforce strict discipline and good order among the Contractor's employees and may not employ on the Work any unfit person or anyone not skilled in the Work assigned, or anyone incompetent or unfit for the duties of that person. When the City determines that a Contractor employee does not satisfy the requirements of this provision, upon notice from the City, the Contractor must ensure that employee performs no further Work and is no longer present at the Work site. Any such Contractor employee may not again be employed on the Work without City approval.
- 8-1.05 Items Necessary for Proper Completion of the Work.** Except as otherwise noted in the Contract Documents, the Contractor will provide and pay for all labor, materials, equipment, permits, fees, licenses, facilities and services necessary for the proper execution and timely completion of the Work in accordance with the Contract Documents.
- 8-1.06 Subcontracting.**
- a. The Contractor must perform with his or her own organization, a value of work amounting to not less than fifty percent (50%) of the contract amount, except that the bid amount for subcontracted "Specialty Items" if so designated in any Special

Provisions may be eliminated from the contract amount and not considered as sub-contracted for the purposes of calculating the value of work to be performed by the Contractor. For the purposes of determining the value of work to be performed by the Contractor pursuant to this provision, materials, equipment, incidentals, etc., shall be considered to have been purchased by the contractor or subcontractor that is to install them. Where a portion of an item is subcontracted, the value of work subcontracted will be based on the estimated cost of such portion of the subcontracted item, as determined from information submitted by the Contractor, subject to approval by the Engineer.

- b. By executing the Contract, the Contractor certifies that no subcontractor included on the list of proposed subcontractors submitted with the Contractor's bid is ineligible to perform work on public works projects pursuant to California Labor Code Sections 1777.1 or 1777.7. In accordance with California Public Contract Code Section 6109(a), subcontractors who are ineligible to perform work on public works projects pursuant to California Labor Code Sections 1777.1 or 1777.7 may neither bid on, be awarded or perform as a subcontractor on the Work. In accordance with California Public Contract Code Section 6109(b), any contract on a public works project entered into between a contractor and a debarred subcontractor is void as a matter of law. The Contractor will ensure that no debarred subcontractor receives any public money for performing the Work, and any public money that may have been paid to a debarred subcontractor for the Work is returned to the City. The Contractor will be responsible for payment of wages to workers of a debarred subcontractor who has been allowed to perform the Work.
- c. The Contract and the performance of the Work are subject to the requirements of the Subletting and Subcontracting Fair Practices Act codified at California Public Contract Code Section 4100 and following. If the Contractor fails to specify a subcontractor or specifies more than one subcontractor for the same portion of the Work in excess of one-half of 1 percent of the Contractor's total bid, the Contractor agrees that the Contractor is fully qualified to perform that portion of the Work with the Contractor's own forces, and that the Contractor will perform that portion of the Work with the Contractor's own forces. If after award of the Contract the Contractor subcontracts, except as provided for in California Public Contract Code Sections 4107 or 4109, any such portion of the Work, the Contractor will be subject to the penalties set forth in California Public Contract Code Sections 4110 and 4111, including cancellation of the Contract, assessment of a penalty of up to 10 percent of the amount of the subcontract, and disciplinary action by the Contractors State License Board.
- d. No contractual relationship exists between the City and any subcontractor engaged in performance of the Work.
- e. Incorporation of Contract Documents. Contractor agrees to include with all subcontractors in their subcontract the same requirements and provisions of this Contract including the indemnity and insurance requirements to the extent they apply to the scope of the Subcontractor's work. Subcontractors hired by Contractor agree to be bound to Contractor and City in the same manner and to the same extent as Contractor is bound to City under the Contract Documents. Subcontractor further agrees to include these same provisions with any sub-subcontractor. A copy of the City's Contract Document indemnity and insurance provisions will be furnished to the

subcontractor upon request. The Contractor shall require all sub-contractors to provide a valid certificate of insurance and the required endorsements included in the agreement prior to commencement of any work and contractor will provide proof of compliance to the City. The Contractor will be solely responsible for any delay or additional costs incurred as a result of its failure to provide adequate or accurate Project information to a subcontractor that results in improper submittals and/or Work, or time or other impacts. The Contractor will have all of the obligations and the City will have all of the remedies that are specified in Section 11 concerning any delay or additional costs incurred due to failure of the Contractor to provide adequate and accurate Project information to subcontractors.

- f. Coordination of Subcontract Work: The Contractor is responsible for scheduling the Work of subcontractors so as to avoid delay or injury to either Work or materials.
- g. Subcontractor agrees to be bound to Contractor and City in the same manner and to the same extent as Contractor is bound to City under the Contract Documents. Subcontractor further agrees to include the same requirements and provisions of this agreement, including the indemnity and Insurance requirements, with any sub-subcontractor to the extent they apply to the scope of the sub-subcontractor's work. A copy of the City's Contract Document indemnity and insurance provisions will be furnished to the Subcontractor upon request.

8-1.07 Insurance. Contractor shall procure and maintain for the duration of the contract, and for 2 years thereafter, insurance against claims for injuries to persons or damages to property which may arise from or in connection with the performance of the work hereunder by the Contractor, his agents, representatives, employees, or subcontractors.

- a. Minimum Scope and Limit of Insurance. Coverage shall be at least as broad as:
 - 1. Commercial General Liability (CGL): Insurance Services Office (ISO) Form CG 00 01 covering CGL on an "occurrence" basis, including products and completed operations, property damage, bodily injury and personal & advertising injury with limits no less than \$2,000,000 per occurrence. If a general aggregate limit applies, either the general aggregate limit shall apply separately to this project/location (ISO CG 25 03 or 25 04) or the general aggregate limit shall be twice the required occurrence limit.
 - 2. Automobile Liability: Insurance Services Office Form CA 0001 covering Code 1 (any auto), with limits no less than \$2,000,000 per accident for bodily injury and property damage.
 - 3. Workers' Compensation insurance as required by the State of California, with Statutory Limits, and Employers' Liability insurance with a limit of no less than \$1,000,000 per accident for bodily injury or disease.
 - 4. Surety Bonds. Contractor shall provide the following Surety Bonds:
 - 1. Bid bond
 - 2. Performance bond
 - 3. Payment bond
 - 4. Maintenance bond (based on final contract amount at time of completion)

The Payment Bond and the Performance Bond shall be in a sum equal to the contract price. If the Performance Bond provides for a one-year warranty a separate Maintenance Bond is not necessary. If the warranty period specified in the contract is for longer than one year, a Maintenance Bond equal to 10% of the contract price is required. Bonds shall be duly executed by a responsible corporate surety, authorized to issue such bonds in the State of California and secured through an authorized agent with an office in California.

5. Professional Liability (if Design/Build), with limits no less than \$2,000,000 per occurrence or claim, and \$2,000,000 policy aggregate. The retroactive date must be shown, and this date must be before the execution date of the contract or the beginning of contract work. Insurance must be maintained and evidence of insurance must be provided for at least five (5) years after completion of contract work. If coverage is canceled or non-renewed, and not replaced with another claims-made policy form with a retroactive date prior to the contract effective, or start of work date, the Contractor must purchase extended reporting period coverage for a minimum of five (5) years after completion of contract work. A copy of the claims reporting requirements must be submitted to the City of Sebastopol for review.
6. Contractors' Pollution Legal Liability and/or Asbestos Legal Liability and/or Errors and Omissions (if project involves environmental hazards) with limits no less than \$1,000,000 per occurrence or claim, and \$2,000,000 policy aggregate. If the services involve lead-based paint or asbestos identification/remediation, the Contractors Pollution Liability policy shall not contain lead-based paint or asbestos exclusions. If the services involve mold identification/remediation,
7. The Contractors Pollution Liability policy shall not contain a mold exclusion, and the definition of Pollution shall include microbial matter, including mold.

If the contractor maintains broader coverage and/or higher limits than the minimums shown above for all policies, the City of Sebastopol requires, and shall be entitled to, the broader coverage and/or higher limits maintained by the contractor. Any available insurance proceeds in excess of the specified minimum limits of insurance and coverage shall be available to the City of Sebastopol.

- b. Self-Insured Retentions. Self-insured retentions must be declared to and approved by the City of Sebastopol. At the option of the City of Sebastopol, either: the contractor shall cause the insurer to reduce or eliminate such self-insured retentions as respects the City of Sebastopol, its officers, officials, employees, and volunteers; or the Contractor shall provide a financial guarantee satisfactory to the City of Sebastopol guaranteeing payment of losses and related investigations, claim administration, and defense expenses. The policy language shall provide, or be endorsed to provide, that the self-insured retention may be satisfied by either the named insured or the City of Sebastopol.

c. Other Insurance Provisions:

1. Additional Insured. The City of Sebastopol, its officers, officials, employees, and volunteers are to be covered as additional insureds on the CGL policy with respect to liability arising out of work or operations performed by or on behalf of the Contractor including materials, parts, or equipment furnished in connection with such work or operations and automobiles owned, leased, hired, or borrowed by or on behalf of the Contractor. General liability coverage can be provided in the form of an endorsement to the Contractor's insurance at least as broad as one of the following ISO ongoing operations Forms: CG 20 10 or CG 20 26 or CG 20 33 (not allowed from subcontractors), or CG 20 38; and one of the following ISO completed operations Forms: CG 20 37, 2039 (not allowed from subcontractors), or CG 20 40.
2. Primary Insurance. For any claims related to this project, the Contractor's insurance coverage shall be primary insurance coverage at least as broad as ISO CG 20 01 04 13 as respects the City of Sebastopol, its officers, officials, employees, and volunteers. Any insurance or self-insurance maintained by the City of Sebastopol, its officers, officials, employees, or volunteers shall be excess of the Contractor's insurance and shall not contribute with it.
3. Notice of Cancellation. Contractor shall provide immediate written notice if (1) any of the required insurance policies is terminated; (2) the limits of any of the required policies are reduced; (3) or the deductible or self-insured retention is increased. In the event of any cancellation or reduction in coverage or limits of any insurance, Contractor shall forthwith obtain and submit proof of substitute insurance.
4. Acceptability of Insurers. Insurance is to be placed with insurers authorized to conduct business in the state with a current A.M. Best rating of no less than A: VII, unless otherwise acceptable to the City of Sebastopol.
5. Waiver of Subrogation. Contractor hereby agrees to waive rights of subrogation which any insurer of Contractor may acquire from Contractor by virtue of the payment of any loss. Contractor agrees to obtain any endorsement that may be necessary to affect this waiver of subrogation, but this provision applies regardless of whether or not the City of Sebastopol has received a waiver of subrogation endorsement from the insurer. However, the Workers' Compensation policy shall be endorsed with a waiver of subrogation in favor of the City of Sebastopol for all work performed by the Contractor, its employees, agents and subcontractors.
6. Verification of Coverage. Contractor shall furnish the City of Sebastopol with original Certificates of Insurance including all required amendatory endorsements (or copies of the applicable policy language effecting coverage required by this clause) and a copy of the Declarations and Endorsement Page of the CGL policy listing all policy endorsements to City of Sebastopol before work begins. However, failure to obtain the required documents prior to the work beginning shall not waive the Contractor's obligation to provide them. The City of Sebastopol reserves the right to require complete, certified copies of all required insurance policies, including endorsements, required by these specifications, at any time.

7. Subcontractors. Contractor shall require and verify that all subcontractors maintain insurance meeting all the requirements stated herein, and Contractor shall ensure that the City of Sebastopol is an additional insured on insurance required from subcontractors. For CGL coverage subcontractors shall provide coverage with a form at least as broad as CG 20 38 04 13.
8. Special Risks or Circumstances. The City of Sebastopol reserves the right to modify these requirements, including limits, based on the nature of the risk, prior experience, insurer, coverage, or other circumstances.

8-1.08 Indemnities. The Contractor shall defend, indemnify and hold the City of Sebastopol, its officials, officers, employees, volunteers and agents free and harmless from any and all claims, demands, causes of action, costs, expenses, liability, loss, damage or injury, in law or equity, to property or persons, including wrongful death, in any manner which actually or allegedly arise out of or are incident to any alleged acts, omissions, negligence or willful misconduct of Contractor, its officials, officers, employees, agents, and subcontractors arising out of or in connection with the performance of the Services, the Project or this Agreement, including without limitation the payment of all consequential damages and attorney's fees and other related costs and expenses except where caused by the active negligence, sole negligence, or willful misconduct of the City, its officers, officials, employees and volunteers. The Contractor shall defend, at Contractor's own cost, expense, and risk, any and all such aforesaid suits, actions or other legal proceedings of every kind that may be brought or instituted against the City, its directors, officials, officers, employees, agents, or volunteers. The Contractor shall pay and satisfy any judgment, award or decree that may be rendered against the City or its directors, officials, officers, employees, agents, or volunteers, in any such suit, action or other legal proceeding. The Contractor shall reimburse the City and its directors, officials, officers, employees, agents and/or volunteers, for any and all legal expenses and costs incurred by each of them in connection therewith or in enforcing the indemnity herein provided. The Contractor's obligation to indemnify shall not be restricted to insurance proceeds, if any, received by the City, its directors, officials, officers, employees, agents or volunteers.

8-1.09 Licenses/Permits. The Contractor must, without additional expense to the City, obtain all licenses, permits and other approvals required for the performance of the Work. This includes a valid City Business license.

8-1.10 California Labor Code and Prevailing Wage Requirements.

- a. In accordance with California Labor Code Section 1810, eight (8) hours of labor in performance of the Work will constitute a legal day's work under the Contract.
- b. In accordance with California Labor Code Section 1811, the time of service of any worker employed in performance of the Work is limited to eight hours during any one calendar day, and forty hours during any one calendar week, except in accordance with California Labor Code Section 1815, which provides that work in excess of eight hours during any one calendar day and forty hours during any one calendar week is permitted upon compensation for all hours worked in excess of eight hours during any one calendar day and forty hours during any one calendar week at not less than one-and-one-half times the basic rate of pay.

- c. The Contractor and its subcontractors will forfeit as a penalty to the City \$25 for each worker employed in the performance of the Work for each calendar day during which the worker is required or permitted to work more than eight (8) hours in any one calendar day, or more than forty (40) hours in any one calendar week, in violation of the provisions of California Labor Code Section 1810 et seq.
- d. In accordance with California Labor Code Section 1773.2, the City has determined the general prevailing wages in the locality in which the Work is to be performed for each craft or type of work needed to be as published by the State of California Department of Industrial Relations, Division of Labor Statistics and Research, a copy of which is on file in the Public Works Department and will be made available on request. The Contractor and subcontractors engaged in the performance of the Work must pay no less than these rates to all persons engaged in performance of the Work.
- e. In accordance with California Labor Code Section 1775, the Contractor and any subcontractors engaged in performance of the Work must comply with Labor Code Section 1775 which establishes a penalty of up to \$50 per day for each worker engaged in the performance of the Work that the Contractor or any subcontractor pays less than the specified prevailing wage. The amount of such penalty will be determined by the Labor Commissioner. The Contractor or subcontractor must pay the difference between the prevailing wage rates and the amount paid to each worker for each calendar day or portion thereof for which each worker was paid less than the prevailing wage rate. If a subcontractor worker engaged in performance of the Work is not paid the general prevailing per diem wages by the subcontractor, the Contractor is not liable for any penalties therefore unless the Contractor had knowledge of that failure or unless the Contractor fails to comply with all of the following requirements:
 - 1. The contract executed between the Contractor and the subcontractor for the performance of part of the Work must include a copy of the provisions of California Labor Code Sections 1771, 1775, 1776, 1777.5, 1813, and 1815.
 - 2. The Contractor must monitor payment of the specified general prevailing rate of per diem wages by the subcontractor by periodic review of the subcontractor's certified payroll records.
 - 3. Upon becoming aware of a subcontractor's failure to pay the specified prevailing rate of wages, the Contractor must diligently take corrective action to halt or rectify the failure, including, but not limited to, retaining sufficient funds due the subcontractor for performance of the Work.
 - 4. Prior to making final payment to the subcontractor, the Contractor must obtain an affidavit signed under penalty of perjury from the subcontractor that the subcontractor has paid the specified general prevailing rate of per diem wages employees engaged in the performance of the Work and any amounts due pursuant to California Labor Code Section 1813.
 - 5. In accordance with California Labor Code Section 1776, the Contractor and each subcontractor engaged in performance of the Work, must keep accurate payroll records showing the name, address, social security number, work classification,

straight time and overtime hours worked each day and week, and the actual per diem wages paid to each journeyman, apprentice, worker, or other employee employed in performance of the Work. Each payroll record must contain or be verified by a written declaration that it is made under penalty of perjury, stating that the information contained in the payroll record is true and correct and that the employer has complied with the requirements of Sections 1771, 1811, and 1815 for any work performed by the employer's employees on the public works project. The payroll records required pursuant to California Labor Code Section 1776 must be certified and must be available for inspection by the City and its authorized representatives, the Division of Labor Standards Enforcement, and the Division of Apprenticeship Standards of the Department of Industrial Relations and must otherwise be available for inspection in accordance with California Labor Code Section 1776.

- f. In accordance with California Labor Code Section 1777.5, the Contractor, on behalf of the Contractor and any subcontractors engaged in performance of the Work, will be responsible for ensuring compliance with California Labor Code Section 1777.5 governing employment and payment of apprentices on public works contracts.
- g. In case it becomes necessary for the Contractor or any subcontractor engaged in performance of the Work to employ on the Work any person in a trade or occupation (except executive, supervisory, administrative, clerical, or other non-manual workers as such) for which no minimum wage rate has been determined by the Director of the Department of Industrial Relations, the Contractor must pay the minimum rate of wages specified therein for the classification which most nearly corresponds to Work to be performed by that person. The minimum rate thus furnished will be applicable as a minimum for such trade or occupation from the time of the initial employment of the person affected and during the continuance of such employment.

8-1.11 Laws and Ordinances. The Contractor and all subcontractors engaged in the performance of the Work must conform to the following specific rules and regulations as well as all other laws, ordinances, rules and regulations that apply to the Work. Nothing in the Special Provisions or Project Plans is to be construed to permit Work not conforming to these codes:

- National Electrical Safety Code, U. S. Department of Commerce
- National Board of Fire Underwriters' Regulations
- California Building Standards Code as adopted by the City
- Manual of Accident Prevention in Construction, latest edition, published by A.G.C. of America
- Industrial Accident Commission's Safety Orders, State of California
- Regulations of the State Fire Marshall (Title 19, California Code of Regulations) and Applicable Local Fire Safety Codes
- Labor Code of the State of California - Division 2, Part 7, Public Works and Public Agencies.
- Federal, state, and local air pollution control laws and regulations applicable to the Contractor and/or the Work.

8-1.12 Guaranty. The Contractor guarantees all of the Work for one year from the date the City accepts the Work. Upon receiving written notice of a need for repairs which are directly attributable to defective materials or workmanship the Contractor must make good any defects arising or discovered in any part of the Work by diligently commencing the necessary repairs within seven (7) days from the date of notice from the City. If the Contractor fails to make good any defects in the Work in accordance with this provision, in addition to any other available remedy under the Contract or at law or equity, the City may make good or have made good such defects in the Work and deduct the cost from amounts that may be due or become due the Contractor, and/or call on the Contractor's maintenance bond for the cost of making good such defects and for the City's reasonable legal costs, if any, of recovering against the bond. The Contractor will remain responsible for repairing any Work found to be defective regardless of when such defect is discovered by the City.

8-1.13 Assignment of Unfair Business Practice Claims. In accordance with California Public Contract Code Section 7103.5, the Contractor and any subcontractors offer and agree to assign to the City all rights, title, and interest in and to all causes of action the Contractor or any subcontractors may have under Section 4 of the Clayton Act (15 U.S.C. § 15) or under the Cartwright Act (Chapter 2 (commencing with § 16700) of Part 2 of Division 7 of the Business and Professions Code), arising from purchases of goods, services or materials pursuant to this Contract. This assignment will be made and become effective at the time the City tenders final payment to the Contractor, without further acknowledgement by the parties.

DRAFT

SECTION 9 Measurement and Payment

9-1.01 F.O.B. (Freight on Board). All shipments must be F.O.B. destination to the Work site and/or other sites indicated in the Contract Documents. The Contract Price is all-inclusive (including sales tax). There will be no additional compensation paid for containers, packing, unpacking, damage, or insurance.

9-1.02 Payment

1. The Contractor shall submit to the Engineer his or her partial payment estimate by the 15th day of the month, or some other day as agreed to by the Contractor and the Engineer prior to the start of the Work. The partial payment estimate must be a verified application for payment and schedule of values supported by a statement showing all materials installed during the preceding month and the cost of labor expended in the performance of the Work. The Contractor must also provide information with the payment that includes bid item identification and % complete/remaining. Unless otherwise provided in the Contract Documents, no allowances or payments will be made for material or equipment not placed at the Work site.
2. Within ten (10) days after the issuance of the Notice to Proceed, the Contractor shall furnish to the City a detailed Schedule of Values giving a complete breakdown of large lump sum prices and items which include numerous subdivisions of work. The Contractor and City shall jointly review the Schedule of Values and make any adjustments in value allocations if, in the opinion of the City, changes are necessary to establish fair and reasonable allocation of values for the Work components. Front end loading will not be permitted. If, in the City's judgment, more detail (i.e., more items of work) is necessary, the Contractor shall add the additional items identified by the City. The City may also require reallocation of Work components from items in the preliminary schedule if such are allocation is necessary. The Contractor shall submit any necessary revisions for the completed Schedule of Values within 15 days from the Notice to Proceed. The costs indicated in making up this breakdown will be used as a basis for partial payments and shall not be considered as fixing a basis of additions or deductions from the contract.
3. To be eligible for payment the Contractor's applications for payment must be accompanied by certified payroll reports, including "Statement of Non-Performance" for periods where no Work was performed. Certified payroll shall be prepared in accordance with California Labor Code Section 1776 and the Contract for each employee of the Contractor and any subcontractors engaged in the performance of the Work during the preceding months. Applications for payment will not be processed without certified payroll reports.
4. In accordance with California Public Contract Code Section 20104.50, the City will review applications for payment as soon as practicable after receipt. Any application or part of an application that is determined to be improper will be returned to the Contractor as soon as practicable, but no later than seven days after receipt by the City, along with a written description of the reasons why the application is improper. The Contractor's failure to submit a schedule by the time specified in Section 3-1.08, or its submission of a schedule to which the City has taken any uncorrected exception, will serve as a basis for returning an application for payment in its entirety.

5. Unless the Contractor has elected to post securities in lieu of retention in accordance with California Public Contract Code Section 22300 and the Contract, and the Contractor and the City have executed an escrow agreement in accordance with the Public Contract Code and the Contract, the City will make progress payments to the Contractor in accordance with applicable law in the amount of ninety-five (95) percent of the value of the labor actually performed and the material incorporated in the Work as specified in Contractor's verified application for payment upon approval by the City's authorized representative(s). Payment of progress payments will not be construed as acceptance of the Work performed. If the Contractor has elected to post securities in lieu of retention in accordance with Public Contract Code Section 22300 and the Contract and the Contractor and the City have executed an escrow agreement in accordance with the Public Contract Code and the Contract, the City will make payments to the Contractor or the Contractor's escrow agent in accordance with such escrow agreement.
6. Wherever the estimated quantities of Work to be done and materials to be furnished on a unit price basis under this Contract are specified in any of the Contract Documents, including the proposal, such quantities are specified for purposes of comparing bids, and the right is expressly reserved, except as otherwise expressly provided, to increase or diminish such quantities as may be deemed reasonably necessary or desirable by the Engineer to complete the Work. No such increase or diminution will be a basis for claims for adjustments in the Contract Price other than adjustments necessary to reflect the impacts of such changes in quantities based on the applicable contract prices and/or pursuant to Section 4 of this Contract.
7. In accordance with California Public Contract Code Section 20104.50, if the City fails to make a progress payment within thirty (30) days of receipt of an undisputed, properly submitted application for payment, the City will pay the Contractor interest equivalent to the legal rate set forth in subdivision (a) of California Code of Civil Procedure Section 685.010. The number of days available to the City to make a payment without incurring an interest obligation pursuant to this provision and California Public Contract Code Section 20104.50 will be reduced by the number of days, if any, by which the City has delayed return of an application for payment beyond the seven day return requirement set forth in Section 9-1.02(d).
8. The City will pay the Contractor's final invoice in accordance with applicable law and this Section 9 following acceptance of the Work provided that:
 - i. The Contractor has furnished evidence satisfactory to the City that all claims for labor and material have been paid, or the time for filing valid stop notices has passed and no stop notices have been filed, or all stop notices filed have been released by valid release or release bond acceptable to the City.
 - ii. No claim has been presented to the City by any person based upon any acts or omissions of the Contractor or any subcontractor engaged in the performance of the Work.
 - iii. No other claim or dispute exists under the Contract or applicable law concerning payment of the Contractor's final invoice and/or release of the Contract retention.

- iv. The Contractor has filed with the City the Maintenance Bond provided in the Contract Documents with duly notarized signatures of an authorized representative of the Contractor and an attorney-in-fact of an admitted surety insurer acceptable to the City and such Maintenance Bond binds the Contractor as Principal and the Surety in accordance with its terms in the amount of 10% of the final Contract Price.

9-1.03 Non-Allowable Direct Charges. The following costs are not allowable direct charges under the Contract. The following costs may only be paid under the Contract, if at all, as part of any allowance for contractor overhead and/or profit established under the Contract.

- a. Labor costs in excess of applicable prevailing wages pursuant to the Contract and applicable law, liability and workers compensation insurance, social security, retirement and unemployment insurance and other employee compensation and benefits pursuant to bona fide compensation plans in effect at the time specified for the opening of Project bids for contractor and subcontractor employees engaged in the performance of the Work, or in excess of the labor costs specified in provision 4-1.05 of this Contract in the case of cost impacts involving items for which the Contract Documents do not specify prices, and for which no lump sum amount has been approved by the City. However, in no event will allowable direct labor charges under the Contract include employee bonuses, employee vehicles or vehicle allowances, employee telephones or telephone allowances, or employee housing or housing allowances, whether or not such benefits are part of a bona fide compensation plan in effect at the time specified for the opening of Project bids.
- b. Superintendent labor and clerical labor.
- c. Bond premiums
- d. Insurance in excess of that required under Section 8.8
- e. Utility costs
- f. Work Site office expenses
- g. Home office expenses.
- h. Permit or license costs

9-1.04 Retention. The City or its agent may, in accordance with the Contract Documents and applicable law, withhold any payment of monies due or that may become due the Contractor because of:

- a. Defective work not remedied or uncompleted work.
- b. Claims filed or reasonable evidence indicating probable filing of claims.
- c. Failure to properly pay subcontractors or to pay for material or labor.

- d. Reasonable doubt that the Work can be completed for the balance then unpaid.
- e. Damage to another contractor.
- f. Damage to the City.
- g. Damage to a third party.
- h. Delay in the progress of the Work, which, in the City's judgment, is due to the failure of the Contractor to properly expedite the Work.
- i. Liquidated damages or other charges that apply to the Contractor under the Contract.
- j. Any other lawful basis for withholding payment under the Contract.

9-1.05 Securities in Lieu of Retention.

- a. In accordance with Public Contract Code Section 22300, except where federal regulations or polices do not permit substitution of securities, the Contractor may substitute securities for any moneys withheld by the City to ensure performance of the Work. At the Contractor's request and expense, securities equivalent to the amount withheld will be deposited with the City, or with a state or federally chartered bank in California as the escrow agent, who will then pay those moneys to the Contractor under the terms of an Escrow for Security Deposit agreement. The Escrow for Security Deposit agreement is provided in the Contract Documents. Upon satisfactory completion of the Work, the securities will be returned to the Contractor.
- b. Alternatively, at the Contractor's request and expense, the City will pay retentions earned directly to the escrow agent. At the Contractor's expense, the Contractor may direct investment of the payments into securities. Upon satisfactory completion of the Work, the Contractor will receive from the escrow agent all securities, interest, and payments received by the escrow agent from the City pursuant to this provision and the terms of the Escrow for Security Deposit agreement. The Contractor will, within 20 days of receipt of payment, pay to each subcontractor the respective amount of interest earned, less costs of retention withheld from each Subcontractor, on monies withheld to ensure the Contractor's performance of the Work.
- c. Securities eligible for investment in accordance with this provision include those listed in Government Code Section 16430, bank or savings and loan certificates of deposit, interest bearing demand deposit accounts, standby letters of credit, or any other security mutually agreed to by the Contractor and the City.
- d. The Contractor will be the beneficial owner of any securities substituted for moneys withheld and will receive any interest thereon.

SECTION 10 Project Acceptance and Closeout

10-1.01 Occupancy. The City reserves the right to occupy or use any part or parts or the entire of the Work before the Work is fully performed. Subject to applicable law, exercising this right will in no way constitute acceptance of any part of the Work so occupied or used or acceptance of the entire Work, nor will such occupancy or use in any way affect the times when payments will become due the Contractor, nor will such occupancy or use in any way prejudice the City's rights under the Contract, any Contract bonds, or at law or equity. Occupancy or use will not waive the City's rights to assess liquidated damages in accordance with Section 7 after the date of such occupancy or use.

10-1.02 Work Completion and Final Inspection. When the Contractor considers the Work is completed, the Contractor will submit written certification to the Engineer specifying that: the Contract Documents have been reviewed; the Work has been inspected for compliance with the Contract Documents; the Work has been completed in accordance with the Contract Documents; and that equipment and systems have been tested in the presence of the City's representative and are operational. The City and/or the City's authorized representatives will make an inspection to verify that the Work is complete and will notify the Contractor in writing of any incomplete or deficient Work. The Contractor will take immediate steps to remedy the stated deficiencies and give notice of correction to the Engineer. Upon receiving a notice of correction, the City or the City's authorized representatives will re-inspect the Work. The Contractor must correct all punch list items within 10 working days after the issuance of the punch list

10-1.03 Work Acceptance.

- a. All finished Work will be subject to inspection and acceptance or rejection by the City, the Engineer or other government agencies having jurisdiction over the Work. Final acceptance of the Work will be at the discretion of the City.
- b. The City will accept the Work in writing only when the Work has been completed to the City's reasonable satisfaction. Progress payments will in no way be construed as acceptance of any part of the Work.
- c. In evaluating the Work, no allowance will be made for deviations from the Special Provisions, Project Plans or other Contract Documents unless already approved in writing in accordance with the requirements of Section 4, above.
- d. The fact that the Work and materials have been inspected from time to time and that progress payments have been made does not relieve the Contractor of the responsibility of replacing and making good any defective or omitted work or materials in accordance with the requirements of the Contract Documents.

SECTION 11 Remedies and Disputes

11-1.01 Failure to Correct Work. Within ten (10) working days of receiving written notice from the City describing Work that is defective or that is otherwise not in accordance with the requirements of the Contract and/or applicable law and directing that such Work be corrected, the Contractor and/or the Contractor's sureties must give the City written notice of the intent of the Contractor and/or the Contractor's sureties to correct such Work and commence correction of such Work in accordance with the City's notice and the Contract. If the Contractor and/or the Contractor's sureties do not give the City written notice of intent to correct such Work and commence correction of such Work within ten (10) working days of receipt of the City's notice, then the City may correct such work and/or have such work corrected for the account and at the expense of the Contractor and/or its sureties, and the Contractor and/or its sureties will be liable to the City for any resulting excess cost. The City may, in addition to all other remedies that the City may have under the Contract and at law or equity, deduct any such excess cost of completing the Work from amounts that are due or that may become due the contractor.

11-1.02 Termination.

- a. In accordance with California Public Contract Code Section 7105, in addition to all other available remedies that the City may have under the Contract, and at law or equity, the City may terminate the Contract:
 1. If the Contractor or any of its subcontractors engaged in the performance of the Work fails to timely perform the Work and/or any of the Contractor's material obligations under the Contract Documents, including but not limited to submission of an acceptable schedule, that have accrued except for due to reasons beyond the control of the Contractor pursuant to the Contract Documents.
 2. If the Contractor is adjudged bankrupt, or if it should make a general assignment for the benefit of creditors, or if a receiver should be appointed on account of its creditors.
 3. If the Contractor or any of the subcontractors engaged in the performance of the Work persistently or repeatedly refuses or fails to supply enough properly skilled workmen or proper materials for the timely completion of the Work.
 4. If the Contractor fails to make prompt payment to subcontractors engaged in the performance of the Work or for material or labor used in the performance of the Work in accordance with the Contract Documents and applicable law.
 5. If the Contractor or any subcontractors engaged in the performance of the Work persistently disregards laws or ordinances applicable to the performance of the Work, or the instructions of the City, the Engineer or other authorized representatives of the City.
 6. For any reason or for no reason, at the City's sole discretion.

- b. If the City intends to terminate the Contractor's control of the Work for any of the reasons specified in Section 11-1.102(a) 1 through 5, above, the City will immediately serve written notice to the Contractor and its sureties in accordance with the Contract Documents. Notice of the City's intent to terminate the Contract will be given by registered or certified mail and specify the grounds for termination, the required cure and the time by which the cure must be effected. Upon receipt of notice of the City's intent to terminate the Contract for any of the reasons specified in Section 11-1.102(a) 1 through 5, the Contractor will have ten (10) days from receipt of the notice or a longer time specified in the notice to cure its default. If the Contractor does not affect the required cure by the time specified in the notice, the City will issue a written notice of termination to the Contractor and its sureties by registered or certified mail. The notice of termination will specify: that upon receipt of the notice the Contractor's right to perform or complete the Work, including on behalf of the Contractor's sureties, is terminated; that the Contractor's sureties will have the right to take over and complete the Work and perform all of the Contractor's remaining obligations that have accrued under the Contract; and that if the Contractor's sureties do not both give the City written notice of their intention to take over and perform the Contract and commence completion of the Work and performance of all of the Contractor's remaining obligations that have accrued under the Contract within ten (10) days after receipt of notice of termination that the City may declare the Contractor's sureties in default and take over the completion of the Work or have the Work completed for the account and at the expense of the Contractor and its sureties, and the Contractor and its sureties will be liable to the City for any resulting excess cost. The City may, in addition to all other available remedies that the City may have under the Contract Documents and at law or equity, deduct any such excess cost of completing the Work from amounts that are due or that may become due the Contractor.
- c. Upon termination of the Contractor's control of the Work for any of the reasons specified in Section 11-1.102(a) 1 through 5, the Contractor will, if so directed by the City, immediately remove from the Work site any and all materials and personal property belonging to the Contractor which have not been incorporated in the Work and the Contractor and its sureties will be liable upon their bond for all damages caused the City by reason of the Contractor's failure to complete the Work.
- d. Upon termination of the Contractor's control of the Work for any of the reasons specified in Section 11-1.102(a) 1 through 5, above, the City reserves the right to refuse tender of the Contractor by any surety to complete the Work.
- e. If the City completes or has completed any portion of, or the whole of the Work, following termination of the Contractor's control of the Work for any of the reasons specified in Section 11-1.102(a) 1 through 5, above, the City will neither be liable for nor account to the Contractor or the Contractor's sureties in any way for the time within which, or the manner in which such Work is performed, or for any changes made in such Work or for the money expended in satisfying claims and/or suits and/or other obligations in connection with completing the Work. If, following termination of the Contractor's control of the Work for any of the reasons specified in Sections Section 11-1.102(a) 1 through 5, above, the unpaid balance of the Contract Price exceeds the expense of completing the Work, including compensation for additional legal, managerial and administrative services and all other amounts due for the completion of the Work and/or satisfaction of claims of the City and/or others arising out of the Contract and any other charges that apply to the Contractor under the Contract, the difference will be paid to the Contractor. If such

expenses of completing the Work exceed the unpaid balance of the Contract Price, the Contractor or its sureties will pay the difference to the City.

- f. If the Contract or Contractor's control of the Work is terminated for any reason, no allowances or compensation will be granted for the loss of any anticipated profit by the Contractor.
- g. In accordance with California Government Code Section 4410, in the event a national emergency occurs, and public work being performed by contract is stopped, directly or indirectly, because of the freezing or diversion of materials, equipment or labor, as the result of an order or a proclamation of the President of the United States, or of an order of any federal authority, and the circumstances or conditions are such that it is impracticable within a reasonable time to proceed with a substantial portion of the work, then the City and the Contractor may, by written agreement, terminate the Contract. In accordance with California Government Code Section 4411, such an agreement will include the terms and conditions of the termination of the contract and provision for the payment of compensation or money, if any, which either party will pay to the other or any other person, under the facts and circumstances in the case. Compensation to the Contractor will be determined on the basis of the reasonable value of the work done, including preparatory work. As an exception to the foregoing, in the case of any fully completed separate item or portion of the Work for which there is a separate contract price, the Contract price will control. The parties may in any other case adopt the Contract price as the reasonable value of the work or any portion of the work done.

11-1.03 Disputes.

- a. In accordance with California Public Contract Code Section 20104.2, the following procedures apply to claims of \$375,000 or less between the Contractor and the City:
 - 1. The claim must be in writing and include the documents necessary to substantiate the claim. Claims must be filed on or before the date of final payment. Nothing in this subdivision is intended to extend the time limit or supersede notice requirements otherwise provided by contract for the filing of claims.
 - 2. For claims of less than fifty thousand dollars (\$50,000), the City will respond in writing to any written claim within 45 days of receipt of the claim, or may request, in writing, within 30 days of receipt of the claim, any additional documentation supporting the claim or relating to defenses to the claim the City may have against the Contractor.
 - 3. If additional information is thereafter required, it will be requested and provided pursuant to this subdivision, upon mutual agreement of the City and the Contractor.
 - 4. The City's written response to the claim, as further documented, will be submitted to the Contractor within 15 days after receipt of the further documentation or within a period of time no greater than that taken by the Contractor in producing the additional information, whichever is greater.

5. For claims of over fifty thousand dollars (\$50,000) and less than or equal to three hundred seventy-five thousand dollars (\$375,000), the City will respond in writing to all written claims within 60 days of receipt of the claim, or may request, in writing, within 30 days of receipt of the claim, any additional documentation supporting the claim or relating to defenses to the claim the City may have against the Contractor.
 6. If additional information is thereafter required, it will be requested and provided pursuant to this subdivision, upon mutual agreement of the City and the Contractor.
 7. The City's written response to the claim, as further documented, will be submitted to the Contractor within 30 days after receipt of the further documentation, or within a period of time no greater than that taken by the Contractor in producing the additional information or requested documentation, whichever is greater.
 8. If the Contractor disputes the City's written response, or the City fails to respond within the time prescribed, the Contractor may so notify the City, in writing, either within 15 days of receipt of the City's response or within 15 days of the City's failure to respond within the time prescribed, respectively, and demand an informal conference to meet and confer for settlement of the issues in dispute. Upon a demand, the City will schedule a meet and confer conference within 30 days for settlement of the dispute.
 9. Following the meet and confer conference, if the claim or any portion remains in dispute, the Contractor may file a claim as provided in Chapter 1 (commencing with Section 900) and Chapter 2 (commencing with Section 910) of Part 3 of Division 3.6 of Title 1 of the Government Code. For purposes of those provisions, the running of the period of time within which a claim must be filed will be tolled from the time the Contractor submits his or her written claim pursuant to subdivision (a) until the time that claim is denied as a result of the meet and confer process, including any period of time utilized by the meet and confer process.
 10. This section does not apply to tort claims and nothing in this article is intended nor will be construed to change the time periods for filing tort claims or actions specified by Chapter 1 (commencing with Section 900) and Chapter 2 (commencing with Section 910) of Part 3 of Division 3.6 of Title 1 of the Government Code.
- b. In accordance with California Public Contract Code Section 20104.4, the following procedures apply to civil actions to resolve claims of \$375,000 or less between the City and the Contractor:
1. Within 60 days, but no earlier than 30 days, following the filing or responsive pleadings, the court will submit the matter to non-binding mediation unless waived by mutual stipulation of both parties. The mediation process will provide for the selection within 15 days by both parties of a disinterested third person as mediator, will be commenced within 30 days of the submittal, and will be concluded within 15 days from the commencement of the mediation unless a time requirement is extended upon a good cause showing to the court or by stipulation of both parties. If the parties fail to select a mediator within the 15-day period, any party may petition the court to appoint the mediator.

2. If the matter remains in dispute, the case will be submitted to judicial arbitration pursuant to Chapter 2.5 (commencing with Section 1141.10) of Title 3 of Part 3 of the Code of Civil Procedure, notwithstanding Section 1141.11 of that code. The Civil Discovery Act of 1986 (Article 3 (commencing with Section 2016) of Chapter 3 of Title 3 of Part 4 of the Code of Civil Procedure) will apply to any proceeding brought under this subdivision consistent with the rules pertaining to judicial arbitration.
 3. Notwithstanding any other provision of law, upon stipulation of the parties, arbitrators appointed for purposes of this article will be experienced in construction law, and, upon stipulation of the parties, mediators and arbitrators will be paid necessary and reasonable hourly rates of pay not to exceed their customary rate, and such fees and expenses will be paid equally by the parties, except in the case of arbitration where the arbitrator, for good cause, determines a different division. In no event will these fees or expenses be paid by state or county funds.
 4. In addition to Chapter 2.5 (commencing with Section 1141.10) of Title 3 of Part 3 of the Code of Civil Procedure, any party who after receiving an arbitration award requests a trial de novo but does not obtain a more favorable judgment must, in addition to payment of costs and fees under that chapter, pay the attorney's fees of the other party arising out of the trial de novo.
 5. The court may, upon request by any party, order any witnesses to participate in the mediation or arbitration process.
- c. In accordance with California Public Contract Code Section 20104.6:
1. The City will not fail to pay money as to any portion of a claim, which is undisputed except as otherwise provided in the Contract.
 2. In any suit filed under Public Contract Code Section 20104.4 concerning this Contract, the City will pay interest at the legal rate on any arbitration award or judgment. Such interest will accrue from date the suit was filed.

SECTION 12 Additional Provisions

12-1.01 Description of Work. The Work in general consists of clearing, grading and construction of a \pm 3,000 foot long stabilized decomposed granite walking trail together with a 42 foot long by 6 foot wide modular bridge crossing of Zimpher Creek, a 154 foot long section of puncheon trail and other such items of work as are required to complete the Project in accordance with this Contract, the Project Improvement Plans and Special Provisions.

All Work shall conform to the requirements of the City of Sebastopol Standard Details and Specification Details as they apply, and any modifications or additions herein and/or on the Project Improvement Plans.

Work shown on the Project Improvement Plans and/or described within the Contract Documents that is not specifically referenced or contained on the bid item list shall be considered as paid for by the various items of work and no additional compensation will be provided.

The estimate of the quantities of Work to be done is approximate only, being as a basis for the comparison of bids, and the City does not expressly or by implication agree that the actual amount of work will correspond therewith but reserves the right to increase or decrease the amount or any portion of the work as directed by the Engineer.

Incidental items of construction necessary to complete the Work in a satisfactory and acceptable manner as shown on the Project Plans and as provided for in the City Special Provisions and not specifically referred to in this section, shall be considered part of the Work and will be understood to be furnished by the Contractor at no additional cost.

12-1.02 Construction Limitations. The Contractor will be expected to conduct his or her operations in a manner, which creates a minimum to the natural vegetation and landscape. Ingress and egress must be via the existing right of way. Care must be exercised to avoid hazards that may cause injury to persons, animals or property either during working hours or after work hours, which will include dust control, backfilling trenches immediately following pipe laying and temporary fencing as required. Excavation made under this Contract must be backfilled before leaving the work for the night.

The Contractor will be responsible for obtaining permission from the property owners for any construction outside of the Work site or easements as shown on the plans. Equipment will be restricted to the immediate area of construction; pipe trenches will be backfilled as soon as possible.

Receptacles for construction residue, including oil, cleaning fluids, and litter, must be covered. Such residues must be disposed of in a proper manner.

Construction activity within the existing right-of-way must be scheduled to minimize traffic inconvenience and safety hazards to motorists, pedestrians and cyclists.

12-1.03 Order of Work. Work as shown on the project plans and described herein shall be constructed in a sequence that is satisfactory to and approved by the Engineer. Additional Order of work requirements may be found on the project plans or within the Special Provisions.

12-1.04 Storm Water Pollution Prevention. The Contractor must perform the Work in compliance with all applicable requirements of the California State Water Resources Control Board pursuant to Order No. 99-08-DWQ, National Pollutant Discharge Elimination System (NPDES) General Permit No. CAS000002 (“General Permit”) adopted pursuant to regulations adopted by the U.S. Environmental Protection Agency (USEPA) on November 16, 1990 and codified in 40 Code of Federal Regulations Parts 122, 123, 124. The General Permit applies to storm water discharges from construction sites that disturb land equal to or greater than one acre, and to construction activity that results in soil disturbances of less than one acre if the construction activity is part of a larger common plan of development that encompasses one or more acre of soil disturbance or if there is significant water quality impairment resulting from the activity. The General Permit requirements that may apply to the Contractor’s performance of the Work include, but are not limited to:

- a. Development and implementation of a Storm Water Pollution Prevention Plan (“SWPPP”) that specifies Best Management Practices (“BMPs”) that will prevent all construction pollutants from contacting storm water and with the intent of keeping all products of erosion from moving off site into receiving waters.
- b. Elimination or reduction of non-storm water discharges to storm sewer systems and other waters of the nation.
- c. Inspection of all BMPs.

Portions of the Work that may be subject to the General Permit include, but are not limited to clearing, grading, stockpiling and excavation.

Prior to commencing performance of the Work, the Contractor must prepare and file a Notice of Intent to obtain coverage under the General Permit, a vicinity map, and the applicable fee, with the California State Water resources Control Board, Division of Water Quality, Storm Water Permit Unit, P.O. Box 1977, Sacramento, California 95812-1977.

Prior to commencing performance of the Work the Contractor must also prepare an SWPPP in accordance with all applicable requirements of the General Permit and submit the SWPPP to the Engineer for approval.

The Contractor must also develop and implement a monitoring program to verify compliance with the General Permit.

The SWPPP must include a Work site map. Geometric equations, notes, details, and all data not related to water pollution control work shall be removed to provide clarity. A copy of the Project Plans must be used as a base plan, with the pertinent stage of construction shown as an overlay to accurately reflect Project site conditions at various phases of construction.

The Contractor must revise and update the SWPPP whenever there is a change in construction operations that may affect the site drainage patterns or discharge of pollutants to surface waters, ground waters, or a separate municipal storm sewer system.

Any fines, damages, Work delays or other impacts that result from failure of the Contractor or privities or agents of the Contractor to fully comply with the requirements of the General Permit or to fully implement the SWPPP will be solely the responsibility of the Contractor.

The Contractor must keep a copy of the General Permit, together with updates and revisions, at the Project site and provide copies of the SWPPP at the request of the City.

12-1.05 Maintaining Traffic and Pedestrian Operations. The Contractor must conduct his or her operations so as to cause the least possible obstruction and inconvenience to public traffic.

Due to the need to accommodate and minimize inconvenience to the public, unless expressly specified or approved in writing by the Engineer, no road closures will be permitted. Public vehicular and pedestrian traffic must be allowed to travel through the Work area with an absolute minimum of interruption or impedance unless otherwise provided for in the Contract or approved in writing by the Engineer. The Contractor must make provisions for the safe passage of pedestrians around the area of Work at all times.

Residents affected by construction must be provided passage and access through the Work area to the maximum extent possible. Where existing driveways occur on the street, the Contractor must make provisions for the trench crossings at these points, either by means of backfill or by temporary bridges acceptable to the Engineer, so that the length of shut-down of any driveway is kept to a minimum. In addition, all driveways must be accessible at the end of each workday, and no driveway or property access may be closed for more than four (4) hours during the workday. Access to driveways, houses, and buildings along the road or street must be as convenient as possible and well maintained, and all temporary crossings must be maintained in good condition. To minimize the need for and complexity of detours, not more than one crossing or street intersection or road may be closed at any one time without the written approval of the Engineer.

The Contractor must provide multiple, advance written notices of closures to all affected property owners in a form approved by the Engineer.

Except as otherwise approved by the Engineer, the stockpiling or storing of material in City streets or right of way shall be prohibited. Where this is unavoidable, all such materials must be piled or stored in a manner that will not obstruct sidewalks, driveways, or pedestrian crossings. Gutters and drainage channels must be kept clear and unobstructed at all times. All such materials shall be stored and handled in a manner that protects City streets, sidewalks, or other facilities from damage.

Where approved in advance by the Engineer, the Contractor must construct and maintain detours for the use of public traffic at his or her own expense. Failure or refusal of the Contractor to construct and maintain detours so approved at the proper time will be a material breach of the Contract subject to any and all remedies available pursuant to the Contract Documents and at law and equity. Such remedies include, but are not limited to, termination pursuant to Section 11.

Throughout performance of the Work the Contractor must construct and adequately

maintain suitable and safe crossings over trenches and such detours as are necessary to care for the public and private traffic at all times including Saturdays, Sundays and holidays.

The Contractor will be responsible for keeping all emergency services, including the Sebastopol police and fire departments informed of obstructions to, or detours around any public or private roads caused by reasons of his or her operations.

The Contractor must comply with the State of California, Department of Transportation Manual of warning signs, lights, and devices for use and performance of work within the job site.

The fact that rain or other causes, either within or beyond the control of the Contractor, may force suspension or delay of the Work, shall in no way relieve the Contractor of his or her responsibility of maintaining traffic through the Project and providing local access as specified in this section. The Contractor must, at all times, keep on the job such materials, force and equipment as may be necessary to keep roads, streets and driveways within the Project open to traffic and in good repair and shall expedite the passage of such traffic, using such force and equipment as may be necessary.

Full compensation for conforming to the requirements of this section will be deemed included in the prices paid or the various Contract items of Work and no additional allowances will be made therefore.

12-1.06 Public Safety. The Contractor must at all times conduct the Work in accordance with Construction Safety Orders of the Division of Industrial Safety, State of California, to ensure the least possible obstruction to traffic and inconvenience to the general public, and adequate protection of persons and property in the vicinity of the work.

No pedestrian or vehicle access way may be closed to the public without first obtaining permission of the Engineer.

Should the Contractor fail to provide public safety as specified or if, in the opinion of the Engineer, the warning devices furnished by the Contractor are not adequate, the City may place any warning lights or barricades or take any necessary action to protect or warn the public of any dangerous condition connected with the Contractor's operations and the Contractor will be liable to the City for, and the City may deduct from amounts due or that may become due the Contractor under the Contract, all costs incurred including, but not limited to, administrative costs.

Nothing in this section will be construed to impose tort liability on the City or Engineer.

12-1.07 Preconstruction Conference. A pre-construction conference will be scheduled, at which time the Contractor must present his or her proposed work schedule in accordance with Section 3-1.08 of the General Provisions, information concerning offsite yards, subcontractors, location of disposal and stockpile areas, and traffic control plans. All such schedules will be subject to the approval of the Engineer and the applicable agencies

12-1.08 Owner Notification. The Contractor must notify all property owners and businesses affected by the Work at least 48 hours before Work is to begin. The notice must be in

writing in the form of a door hangar, and must indicate the Contractor's name and phone number, type of work, day(s) and time when Work will occur. Notices must be reviewed in advance and approved by the Engineer.

12-1.09 Emergency Service Providers Notifications. The Contractor must furnish the name and phone number of the Safety Supervisor appointed in Section 13 to the City Police Department dispatcher for contact in the event of an emergency and shall keep such information updated as required to provide 24-hour phone access.

12-1.10 Clean up. Section 4-1.02 of the Caltrans Standard Specifications is made a part of this Contract.

Before final inspection of the work, the Contractor must clean the construction site and all ground occupied by them in connection with the work, of all rubbish, excess material, falsework, temporary structures and equipment. All parts of the work shall be left in a neat and presentable condition.

Nothing herein shall require the Contractor to remove warning, regulatory, and guide signs prior to formal acceptance by the Engineer.

12-1.11 Obstructions. Section 15, "Existing Highway Facilities", of the Caltrans Standard Specifications, is made a part of this Contract; except that measurement and payment shall be as described herein.

Attention is directed to the possible existence of overhead and underground power, telephone, and television cable poles, underground sewer mains and laterals, underground gas mains, and underground water mains and laterals within the area in which construction is to be performed.

Prior to starting work (a minimum of 2 working days in advance), the Contractor must call Underground Service Alert (USA), toll free (800) 642-2444 and provide USA with all necessary data relative to the proposed work. USA will accept calls and process information to participating agencies that have underground facilities in the area between the hours of 7:30 a.m. and 5:00 p.m. daily, except Saturdays, Sundays, and holidays. Between the hours of 5:00 p.m. and 7:30 a.m. calls will be recorded and then processed after 7:30 a.m. For emergency situations, after hours and on Saturdays, Sundays and holidays, the Contractor shall contact the organization owning the affected facility. Upon notification, agencies having facilities in the area of the proposed excavation will mark their locations in the field using USA standard colors and codes to identify the facility.

The Contractor will be required to work around public and private utility facilities and other improvements that are to remain in place within the construction area and he will be held liable to the owners of such facilities or interference with service resulting from his operations.

12-1.12 Hours of Work. Unless otherwise specified herein, all construction activity, except for emergency situations, will be confined to Monday through Friday between the hours of 7:00 a.m. and 5:30 p.m. Mufflers and/or baffles will be required on all construction equipment to control and minimize noise. The Contractor must comply with all applicable noise regulations in the City's Municipal Code.

Saturday, Sunday, holidays and overtime shall not be regarded as working days. Work shall not be allowed on non-working days without the expressed approval of the Engineer. The Contractor shall make a request for approval in writing with the stipulation (implied or expressed) that the Contractor shall pay for all overtime labor charges at the City's actual cost recovery rate for the City's contract inspector and/or resident engineer. All overtime labor charges shall be deducted from the final payment along with any liquidated damages.

Work necessary for the proper care and protection of work already performed or in case of emergency may be allowed without permission of the Engineer.

12-1.13 Dust Control. The Contractor must furnish all labor, equipment, and means required and carry out effective measures wherever and as often as necessary to prevent its operation from producing dust in amounts damaging to property, cultivated vegetation, or domestic animals, or causing a nuisance. The Contractor will be responsible for any damage resulting from any dust originating from the performance of the Work. The use of water resulting in mud on streets, sidewalks, or driveways, will not be permitted as a substitute for sweeping or other methods of dust control. The Contractor may not discharge smoke, dust, or any other air contaminants into the atmosphere in such quantity as will violate the regulations of any legally constituted authority.

Dust control must conform to the provisions in Section 10-5, "Dust Control", of the Caltrans Standard Specifications, which section is made a part of this Contract.

No separate payment will be made to the Contractor for controlling dust, whether caused by construction traffic or by public traffic only. Full compensation for dust control will be considered as included in the Contract Price paid for the various items of work and no additional compensation will be allowed, therefore.

12-1.14 Water For Construction And Dust Control. Contractors may obtain water from a filler line located at the City Corporation Yard, 714 Johnson Street, or from an alternate source approved by the Public Works Superintendent prior to the start of construction. Contact the Sebastopol Public Works Department for information. Unauthorized use of City hydrants or water outlets is not allowed and will result in legal proceedings by the City of Sebastopol.

12-1.15 Sanitary Provisions. The Contractor must maintain such camps, as he or she may establish for the housing and feeding of the laborers, employed by him or her for the Work, in accordance with the status and general health laws of the State of California pertaining to the sanitation of dwelling and camps and in conformity with such rules and regulations pertaining to labor camps, as have been or may hereafter be prescribed by the State Board of Health or by the Commission of Emigration and Housing of California acting in conjunction with said State Board of Health.

12-1.16 Protection And Restoration Of Vegetation. Trees, lawns, shrubbery and vegetation that are not to be removed must be protected from damage or injury. Existing trees, shrubs, and other plants, that are not to be removed and are injured or damaged by reason of the Contractor's operations, must be replaced by the Contractor in accordance with the requirements in Section 20-3.01C(4), "Replacement Plants", of the Caltrans Standard Specifications. Section 20-3.01C(4) of the Caltrans Standard Specifications is made a part of this Agreement.

When it is necessary to excavate adjacent to existing trees, shrubs, or hedges, the Contractor must use all possible care to avoid injury to the trees, shrubs, or hedges and their roots. No roots or limbs two inches (2") or larger in diameter may be cut without the express approval of the Engineer.

All roots two inches (2") in diameter and larger left in place must be wrapped with burlap to prevent scarring or excessive drying. When it is necessary to cut limbs and branches of trees to provide clearance for equipment used in construction, the Contractor must repair the damaged areas by properly painting with an emulsified asphalt type seal. All cuts through 1/2" or larger roots and limbs must be hand trimmed and cleanly cut before being repaired.

12-2.01 Cultural Resources. In accordance with the National Historic Preservation Act of 1966 (U.S.C. 470), the following procedures are implemented to insure historic preservation and fair compensation to the Contractor for delays attendant to the cultural resources investigation. Contractor hereby agrees to comply with these procedures.

12-2.02 Surplus Material. All material removed or excavated during the course of construction will be surplus. All surplus material will be the property of the Contractor and be disposed of outside the right-of-way, unless the City elects to salvage certain objects that are determined to be of historical interest. The City reserves the right of ownership of all objects that it elects to salvage, and the Contractor must protect such objects from subsequent damage until delivered unto the care of the owner.

12-2.03 Historical Finds. In the event potential historical, architectural, archeological, or cultural resources (hereinafter called cultural resources) are discovered during subsurface excavations at the site of construction, the following procedures will apply:

1. The Contractor must immediately notify the Engineer and stop any Work which may jeopardize the find pending an investigation of its significance;
2. The Engineer will select a qualified archeologist (such as through the Northwest Information Center at Sonoma State University or other official contact) and wait for an archaeologist to complete an evaluation of significance before continuing Work in that area.
3. The Engineer will supply the Contractor with a "Stop Work Order" directing the Contractor to cease all portions of the Work that the Engineer determines may impact the find. The "Stop Work Order" will be effective until a qualified archaeologist assesses the value of the potential cultural resources. The "Stop Work Order" will contain the following:
 - a. A clear description of the Work to be suspended;
 - b. Any instructions regarding issuance of further orders by the Contractor for materials services;
 - c. Guidance as to action to be taken regarding subcontractors;
 - d. Any direction to the Contractor to minimize costs; and
 - e. Estimated duration of the temporary suspension.

4. If the archaeologist determines the potential find is a bona fide cultural resource, the Engineer may extend the duration of the "Stop Work Order" in writing, and if so the "Stop Work Order" will remain in effect and Work subject to the "Stop Work Order" may not resume work until authorized by the Engineer.

12-2.04 Cultural Resources Defined. Possible indicators that a cultural resource has been found include, but are not limited to the following:

1. Prehistoric-era archaeological site indicators: obsidian tools, tool manufacture waste flakes, grinding and other implements, dwelling sites, animal or human bones, fossils, and/or locally darkened soil containing dietary debris such as bone fragments and shellfish remains.
2. Historic-era site indicators: ceramic, glass, and/or metal.

12-2.05 Engineer's Discretion. Once possible cultural resources are found at the Work site, the Engineer may use discretion to continue the work, regardless of the cultural resource find, if the Engineer determines that there are overriding considerations such as the instability of the excavation site, that there are weather or other conditions which would preclude leaving the site exposed, or if the site would be unsafe to workers who would retrieve cultural resource items from therein.

DRAFT

SECTION 13 Safety Rules and Requirements

13-1.01 General

- a. Within ten (10) working days following notice of award the Contractor must submit to the City a safety program for the Work site (“Contractor’s Safety Program”) and provide evidence that the Contractor’s safety policies and procedures relevant to the Work.
- b. The Contractor shall insure that its employees and subcontractors, as well as visitors and others brought onto the Work site under the authority of the Contractor, shall, at all times, observe all applicable Local, State and Federal safety requirements as well as the safety rules and requirements contained in this Contract including, but not limited to, the Contractor’s Safety Program.
- c. In accordance with generally accepted construction practices and applicable law, the Contractor will be solely and completely responsible for conditions at the Work site, including safety of all persons and property during performance of the Work. This requirement will apply continuously and not be limited to normal working hours. For purposes of California Labor Code Section 6400 and related provisions of law, the Contractor and the Contractor’s privities and any other entities engaged in the performance of the Work will be “employers” responsible for furnishing employment and a place of employment that is safe and healthful for all employees of any such entities engaged in the performance of the Work. Neither the City nor its officials, officers, employees, agents, volunteers or consultants will be “employers” pursuant to California Labor Code Section 6400 and related provisions of law with respect to the Contractor, the Contractor’s privities or other entities engaged in the performance of the Work.
- d. The Contractor agrees with respect to the Work, and the Work site, the Contractor will be responsible for not creating hazards and for having hazards corrected and/or removed, for taking appropriate, feasible steps to protect the Contractor’s employees from such hazards and that the Contractor has instructed and/or will instruct its employees to recognize such hazards and how to avoid the associated dangers.
- e. The Contractor will be solely responsible for the implementation and maintenance of safety programs to ensure that the Work site is maintained and the Work is performed in a safe manner in accordance with the Contract and applicable law. If the Contractor damages City equipment or property, the Contractor shall report the incident to the Engineer on or before the next calendar day and provide such information as necessary for the City to evaluate the damage.
- f. The Contractor shall submit a written request to the Engineer in order to obtain keys or other devices to gain access to City facilities. Keys and other devices shall not be copied or otherwise replicated and shall remain in the possession of

the Contractor and its employees or subcontractors at all times and shall be returned to the City when no longer required to complete the Work.

- g. The Contractor must furnish and place proper guards and systems for the prevention of accidents, including, but not limited to, those systems required pursuant to Title 8, Section 1670 et seq. of the California Code of Regulations concerning safety belts and nets. The Contractor must provide and maintain any other necessary systems or devices required to secure safety of life or property at the Work site in accordance with accepted standards of the industry and applicable law. The Contractor must maintain during all night hours sufficient lights to prevent accident or damage to life or property.
- h. Examination, inspection, investigation, and review by the City and or its employees and representatives, of the Contractor's Safety Plan or the Contractor's performance of the Work will not constitute review or approval of the adequacy of the Contractor's safety measures in, on, or near the Work site and shall not relieve the Contractor of any of the Contractor's obligations under the Contract and applicable law to ensure that the Work site is maintained and the Work is performed in a safe manner.

13-1.02 Safety Supervisor; Hazardous Substances

- a. The Contractor shall designate an individual who is qualified and authorized to supervise and enforce compliance with the Contractor's Safety Program ("Safety Supervisor"). The Contractor shall notify the Engineer in writing prior to the commencement of the Work of the name and contact information of the Safety Supervisor. The Safety Supervisor shall be either a full-time employee of the Contractor or a contracted safety consultant with experience and/or professional certifications indicating experience in construction safety. The Safety Supervisor shall provide the City, upon request, with weekly safety inspection reports identifying hazards found and corrective actions taken. The Safety Supervisor shall also be responsible for supervising compliance with applicable safety requirements on the Work site and to develop and implement safety training for all job personnel. The City shall have the authority, but not the duty, to require the Contractor replace the Safety Supervisor if the Supervisor's performance is judged by the City to be improper or inadequate.
- b. Prior to beginning the Work, the Contractor shall review the City's Hazard Communication Program. In addition, if the Contractor brings any substance onto City property, other than gasoline or diesel fuel, for which a manufacturer has prepared a Materials Safety Data Sheet (*MSDS*), in quantities greater than 25 pounds, 200 cubic feet, or five gallons; or any substance defined in Cal/OSHA regulations as "acutely hazardous;" or if the Contractor's work activities may expose City employees to any of the substances described above, the Contractor shall first complete and submit to the Engineer a "Report of Use/Storage of Hazardous Substances on City Property" form (*form(s) provided at Project's Pre-Construction meeting*).

13-1.03 Non-Compliance with Safety Rules and Regulations

- a. In the event the Contractor fails to comply with applicable Local, State and Federal safety requirements, or the safety rules and requirements contained in this Contract including the provisions of the Contractor's Safety Plan, the City reserves the right to (i) notify the Contractor of its failure to comply, and the reasons therefore, and require that the Contractor immediately undertake, at Contractor's own expense, all actions necessary to bring the Contractor and/or the Project into compliance and (ii) exercise the right to suspend all or part of the Work if the Contractor fails or refuses to undertake and complete such corrective action within the time specified in the notice.
- b. No extension of time or additional compensation will be granted as a result of any suspension of the Work and any issuance by the City of any notice or suspension order shall not operate to waive or otherwise diminish the (i) Contractor's obligations under this Contract to provide a safe Work site or (ii) City's right to pursue or enforce any remedy, power or right under the Contract or otherwise available at law.

13-1.04 Accidents and Safety Emergencies

- a. In accidents or emergencies affecting the safety or protection of persons, the Work, the Work site, or property adjacent thereto, the Contractor shall immediately act to prevent threatened damage, injury or loss and notify the Engineer as soon as possible of the facts and circumstances surrounding the emergency including the involvement of any emergency responders (police, fire, medical, etc.).
- b. The City reserves the right to conduct an investigation of the accident or emergency either in conjunction with, or separate of, the Contractor, and the Contractor shall provide the City all access necessary to permit the City to perform a full and complete investigation, the scope of which shall be at the sole discretion of the City.
- c. Within 24 hours of accidents or emergencies involving in-patient hospitalization or a fatality, the Contractor shall provide the Engineer with a completed Contractor's Injury/Fatality Incident Report (*form(s) provided at Project's Pre-Construction meeting*). The Contractor shall also notify the Engineer in writing of any claims brought against the Contractor, or any subcontractor, judicial or otherwise, related to any such injuries and/or fatalities including a copy of such claim(s).

PART 3 SPECIFICATIONS

SECTION 14-1 General

14-1.01 PROGRESS SCHEDULE AND SUBMITTALS

MATERIALS AND EXECUTION

Progress Schedule

Progress schedules will be required for this contract and shall conform to the provisions in **Section 8, "Prosecution and Progress,"** of the 2018 State Standard Specifications and these Specifications.

Scheduling of work shall conform to **Section 8-1.02, "Schedule"** of the 2018 State Standard Specifications and these Specifications. The Contractor shall prepare and have accepted by the City Engineer a schedule for performing work. Submittal of a revised schedule will not supersede a previous schedule until it is accepted in writing by the City Engineer. The Contractor shall submit a general schedule five (5) working days prior to the pre-construction conference. This schedule shall contain general information for each phase of the project, such as the start and finish dates for each item of work. The Contractor shall submit a more updated schedule as work progresses, when requested by the City Engineer. The Contractor shall submit the original schedule to the City Engineer at least two weeks prior to the start of construction so that the City Engineer has time to review the schedule and request changes.

The Contractor shall maintain access to residences and businesses affected by the project throughout the life of the contract as specified in the General Provisions of these Contract Documents. The Contractor shall at no time block access to residences or businesses. Contractor shall submit a site plan showing all desired access areas and laydown/construction areas for City approval prior to implementation.

Submittals

Not later than 15 working days prior to the start of work, the Contractor shall submit to the City Engineer for approval, shop drawings of, Certificates of Compliance for, and samples of (if requested) all the materials proposed for use on the work.

The Contractor shall include in the submittal package to the City a completed City of Sebastopol "Transmittal Form" detailing the items included in the submittal. A copy of the City's "Transmittal Form" can be obtained by contacting the Department of Public Works.

Submittals shall include but not be limited to the following items:

- A. Construction Schedule
- B. Stormwater Pollution Prevention Plan
- C. Erosion and Sediment Control Plan
- D. Class 2 Aggregate Base
- E. Weed Barrier Fabric
- F. Stabilized Decomposed Granite
- G. Metal Path Edging

- H. Pressure Treated Douglas Fir Decking
- I. Pressure Treated Douglas Fir Joists
- J. Precast Concrete Pier Blocks
- K. Cast in Place Concrete Design Mix
- L. Modular Bridge Assembly and Components
- M. Signs and Sign Posts
- N. Removable Bollards
- O. HDPE Culverts

Samples shall be clearly marked to show the manufacturer's name and product identification. Certificates of Compliance shall be original documents signed by the manufacturer indicating the product complies with the Contract Documents.

The City will not compensate the Contractor for the purchase or installation of materials lacking the City Engineer's written approval.

Control of materials shall conform to **Section 6, "Control of Materials,"** of the 2018 State Standard Specifications.

MEASUREMENT AND PAYMENT

Payment to the Contractor for all costs associated with **SUBMITTALS** shall be included in the various bid items and no additional compensation will be allowed therefor.

14-1.02 DUST CONTROL

MATERIALS AND EXECUTION

Contractor is referred to dust control provisions included in Section 12-1.13 "Dust Control" of the General Provisions Section of these Contract documents.

MEASUREMENT AND PAYMENT

Payment to the Contractor for all costs associated with **DUST CONTROL** shall be included in the various bid items and no additional compensation will be allowed therefor.

14-1.03 STORM WATER POLLUTION PREVENTION (SWPPP)

MATERIALS AND EXECUTION

Contractor is referred to Storm Water Pollution Prevention (SWPPP) provisions included in Section 12-1.04 "Storm Water Pollution" of the General Provisions Section of these Contract Documents.

MEASUREMENT AND PAYMENT

Payment to the Contractor for all costs associated with the preparation and implementing **STORM WATER POLLUTION PREVENTION** shall be included in the lump sum payment for this item of work and no additional compensation will be allowed therefor.

14-1.04 EROSION AND SEDIMENT CONTROL PLAN

MATERIALS AND EXECUTION

The Erosion and Sediment Control Plan prepared by the Contractor for this Project shall conform to the *Erosion and Sediment Control Field Manual, Third Edition, June 1999* (“*Field Manual*”), by the California Regional Water Quality Control Board, San Francisco Bay Region. The requirements included in the *Field Manual* are incorporated herein in its entirety. A copy of the *Field Manual* may be obtained from the California Environmental Protection Agency State Water Resources Control Board Water Quality home page, <http://www.waterboardsl.ca.gov/stormwtr/training.html> under “Publications Available”.

The City shall periodically inspect the Contractor’s work to ensure that work conforms to these erosion control guidelines and requirements.

In accord with the provisions of the *Field Manual* and the City’s Storm Water Management Plan, the City shall perform erosion control follow-up and maintenance and be responsible for post construction storm water protection following completion of the project.

The Contractor shall conform to all of the requirements contained in these contract documents and Special Provisions and any other documents referenced herein.

EROSION CONTROL

Contractor shall conform with the requirements contained in these Special Provisions.

1. Scheduling: The key to keeping potentially hazardous construction materials (PHCM) out of storm water is to perform most of the construction (earthwork and foundation work) during the dry season. All erosion control facilities shall be in place by October 15, or before the first rains – whichever comes first. All PHCMs shall be covered with tarps and elevated off the ground if rain is predicted.
2. Chemical Storage: Chemicals shall be stored in their original containers or in well-labeled, sealed containers in designated areas.
3. Drainage: PHCMs shall not be transported, applied, or washed within areas which drain to the City Storm Drain System.
4. Construction Equipment and Vehicles – Maintenance
 - a. Maintain all construction equipment to prevent oil or other fluid leaks.
 - b. Use drip pans for any oil or fluid changes that are required for maintenance of equipment. Keep vehicles and equipment clean. Do not allow excessive build-up of oil and grease.
 - c. Use off-site repair shops as much as possible.
 - d. Always use secondary containment, such as drain pans or drop cloths, to catch spills or leaks when removing or changing fluids.
 - e. Place stockpiled spill cleanup materials where they will be readily accessible. Regularly inspect on-site vehicles and equipment for leaks, and repair immediately. Check incoming vehicles and equipment (including delivery trucks and employee and subcontractor vehicles) for leaking oil and fluids. Do not allow leaking vehicles or equipment on-site.
 - f. Segregate and recycle wastes, such as greases, used oil or oil filters, antifreeze, cleaning solutions, automotive batteries and hydraulic and transmission fluids.

5. Construction Equipment and Vehicles – Fueling
 - a. Use off-site fueling stations as much as possible.
 - b. If fueling must occur on-site, use designated areas, located away from drainage. Locate on-site fuel storage tanks over a retention area designed to hold the total tank volume.
 - c. Cover the retention area with an impervious material and install it in a manner to ensure that any spills will be contained in the retention area.
 - d. Discourage “topping-off” of fuel tanks, as it frequently leads to fuel spillage.
 - e. Always use secondary containment, such as drain pans or drop cloths, when fueling to catch spills / leaks.
 - f. Place stockpiled spill cleanup materials where they will be readily accessible.
 - g. Avoid mobile fueling of mobile construction equipment around the site; transport the equipment to designated fueling areas.
6. Construction Equipment and Vehicles – Washing
 - a. Use off-site commercial washing businesses as much as possible.
 - b. Washing vehicles and equipment outdoors or in areas where wash water flows onto paved surfaces or into drainage pathways can pollute storm water. If you wash a large number of vehicles or pieces of equipment, conduct this work at an off-site commercial facility.
 - c. Do not permit steam cleaning on-site. Steam cleaning can generate significant pollutant concentration.
7. Construction Equipment and Vehicles – Storage
 - a. Locate vehicle and equipment storage, cleaning and maintenance areas in designated, confined areas. These areas should be located away from significant drainage courses.
 - b. Direct any concentrated storm water run-on/runoff with stored equipment by raising equipment on pallets or other similar devices.
8. Toxic Materials: Through proper material use, waste disposal and training of employees, the discharge of toxic pollutants can be prevented. Such methods include the following:
 - a. Dispose of all wastes in accordance with Federal, State and local regulations.
 - b. Use the entire product before disposing of the container.
 - c. Do not remove the container’s original product label prior to disposal. It contains important safety and disposal information.
 - d. Do not clean out brushes or paint containers on dirt or into streets, gutters, storm drains, or streams. “Paint out” brushes as much as possible. Rinse water-based paints to the sanitary sewer. Filter and reuse thinners and solvents. Dispose of excess oil-based paints and sludge as hazardous waste.
 - e. Select and site designated hazardous waste storage areas.
 - f. Store hazardous materials and wastes in covered containers and protect from vandalism. Place hazardous material and waste containers in secondary containment.
 - g. Do not mix wastes. Mixing can cause chemical reactions, making recycling impossible, and complicate disposal.
 - h. Recycle any useful material such as oil or water-based paint. Provide a summary of available recycling and disposal services.
 - i. Make sure that toxic liquid wastes and chemicals are not disposed of in dumpsters designated for construction debris.
 - j. Arrange for regular waste collection before containers overflow.
 - k. Make sure that hazardous waste is collected, removed and disposed of only at authorized disposal areas.

MEASUREMENT AND PAYMENT

The contract lump sum paid to the Contractor for **EROSION AND SEDIMENT CONTROL PLAN** shall include all costs associated with preparation and execution of the Erosion and Sediment Control Plan as specified in these Specifications and as directed by the Engineer and no additional compensation will be allowed therefor.

14-1.05 MOBILIZATION AND PROJECT SIGNAGE

MATERIALS AND EXECUTION

Mobilization shall consist of preparatory work and operations, including, but not limited to those necessary for the movement of personnel, equipment, supplies and incidentals to the project site; for the establishment of all project field offices, laydown and storage area fencing and other facilities necessary for the work on the project; and for all other work and operations which must be performed or costs incurred prior to beginning work on the various contract items on the project site. The locations of any existing underground utilities shall be verified.

The Contractor shall submit two copies of photos of the jobsite prior to the start of construction, for the purpose of providing a record of existing conditions. These photos shall provide a view encompassing the entire project with sufficient clarity and scope that will satisfy the City Engineer. The photos should include and confirm utility markings prior to excavation. The Contractor shall submit these photos with a written log stating any defects or irregularities in the existing improvements along the proposed improvements. The log shall also state the location, date, and time the photos were made. Upon acceptance by the City Engineer, the photos and logs shall become the property of the City. The photos shall include existing vegetation to be cleared and removed during construction.

Contractor shall be responsible for erecting, maintaining, and removing project informational signs located at entrances to project areas (total of two signs). Signs shall be installed per City Standards and **Section 14.2-11, "Project Area Signs,"** of these Specifications 7 days before beginning work. Prior to sign installation, the Contractor shall submit a plan to the City for approval identifying the locations where project informational signs are to be installed.

The informational sign shall meet the design layout as directed by the City with dimensions of 6 feet wide by 3 feet high, City of Sebastopol and (Funding insert Agency) logo. The sign must be attached on at least two 4-inch by 4-inch posts at heights acceptable to the City Engineer.

Insert Project Sign

The project sign material shall be durable and waterproof material, such as vinyl, plastic or aluminum. The font shall be Gill Sans or similar with minimum 4" high upper case black letters on white background and shall be regular and bold only, no condensed or expanded typefaces shall be used. The entire sign shall be vector art. Contractor shall work with sign manufacturer and the City to determine final layout, colors, and size of the sign. Line spacing shall be approximately one inch. A mockup shall be submitted for approval by City. Minor variations as required to appropriately layout the sign are acceptable.

Sanitary restroom facilities shall be provided and maintained, by the Contractor, on the project site. The Contractor's proposed locations for restroom facilities shall be reviewed with the Engineer prior to delivery and placement of the restroom facility.

The Contractor shall develop a temporary construction staging area for the storage and operation of construction equipment and supplies. The Contractor shall submit a plan describing the construction staging area to the Engineer for approval. The Contractor shall not permit any waste or damage to the staging area and shall maintain the area in good condition, free of litter and debris. Upon completion of the work, the area shall be restored to its pre-construction or better condition, including the repair of any damaged pavement, landscaping, curbs, markings, or other public infrastructure components. If the Contractor proposes to use the City's Community Park area as a construction staging area, the Contractor shall submit maintenance and restoration plan for City's written approval.

City staff shall be allowed access to the Project site at all times. Security and use of the work area is at the Contractor's own risk. The Contractor shall cooperate and coordinate the work accordingly with City staff and make allowances for the work by City maintenance crews and other contractors. The City shall not be held responsible for any damage or extra cost sustained by the Contractor resulting directly or indirectly from said work by City forces or other contractors and agencies. The Contractor shall not cause any unnecessary hindrance or delay to any other contractor or agencies working nearby or within the work site.

MEASUREMENT AND PAYMENT

The contract lump sum price paid for **MOBILIZATION AND PROJECT SIGNAGE** includes full compensation for furnishing all labor, materials, tools, equipment, and incidentals, and for doing all the work involved in Mobilization, complete in place, including installing project signage and posts and verifying the location of existing underground utilities, as specified in these Specifications, and as directed by the Engineer and no additional compensation shall be allowed therefor.

SECTION 14-2 Technical Specifications

14-2.01 CLEARING AND GRUBBING

MATERIALS AND EXECUTION

In areas to be cleared, Contractor is to remove and dispose of shrubs, brush, limbs, surface vegetation and tree roots. Remove all evidence of their presence from the surface including sticks and branches greater than 2 inches in diameter or thickness. Remove and properly dispose of off-site trash piles, rubbish and debris.

Protect trees, vegetative growth and fencing which are not designated for removal. Protect existing trail signs, benches and appurtenances. Unless otherwise directed by the Engineer, existing trees and vegetation not designated for removal and that do not interfere with construction of new improvements shall remain protected in place.

Inspect the site as to the nature, location, size, and extent of vegetative material to be removed, trimmed or protected, as specified herein and as shown on the Improvement Plans. Preserve trees and shrubs that are specifically shown on the Improvement Plans or identified by the Engineer as designated to be protected or are located beyond the limits of clearing and grubbing. Trim existing trees as required to complete the Project trail and bridge improvements.

Remove or clear vegetation or obstructions that interfere with installation of new construction. Strippings shall not be incorporated in any trail backfill, embankment or engineered fill section. Voids left by the removal of vegetation, root balls or other underground structures, if found, or any other soft or loose soil pockets shall be over-excavated and backfilled with properly compacted, approved native soils that are free of organic and other deleterious materials, or with approved imported fill.

Except as otherwise directed by the Engineer, materials cleared and grubbed shall become the property of the Contractor and shall be properly disposed of offsite in accordance with City of Sebastopol laws, codes and ordinances. Do not burn combustible material unless prior written authorization is obtained from the City. Upon completion of the site clearing work, premises to receive new construction shall be neat, clean and in suitable condition for construction of new work.

MEASUREMENT AND PAYMENT

The contract lump sum price paid for **CLEARING AND GRUBBING** includes full compensation for furnishing all labor, materials, tools, equipment, and incidentals, for doing all work involved in clearing and grubbing vegetation, tree roots and trees as needed to construct the proposed trail and bridge improvements, as specified in the Contract Documents, Improvement Plans and as directed by the Engineer and no additional compensation shall be allowed therefor.

14-2.02 EARTHWORK

MATERIALS AND EXECUTION

Density of soil will be determined in place by the sand cone method, ASTM D 1556 or by nuclear methods, ASTM D 2922 and D 3017. Compaction tests will be performed by the City's Engineer or Inspector. Laboratory moisture-density relations of soils will be determined per ASTM D 1557 test method. Relative density of cohesionless soils will be determined per ASTM D 4253 and D 4254. Backfill materials will be sampled per ASTM D 75. Compaction shall be deemed to comply with the specifications when no more than one test of any three consecutive tests falls below the specified

relative compaction. The one test shall be no more than three percentage points below the specified compaction. The Contractor shall pay the costs of any retesting of work not conforming to the specifications

Required minimum compaction shall be as follows:

Finished Subgrade	90%
Embankment	90%
Engineered Fill	90%
Pipe Bedding and Backfill	90%
Class 2 A.B.	90%
Decomposed Granite	90%
Structural Backfill	95%

When density tests indicate that the density of any layer of fill or portion thereof is below the required compaction, the particular layer or portion shall be reworked at the Contractor's expense until the required density has been obtained.

Embankment and fill materials shall not be placed, spread or rolled during unfavorable weather conditions or when ground conditions are too wet to achieve specified compaction. When the Work is interrupted by unfavorable conditions such as heavy rains, embankment and fill operations shall not be resumed until the Engineer or Inspector indicates that the moisture contents of the subgrade and fill materials are satisfactory.

Fill Materials

Import fill material shall be submitted for review and approval by the Engineer. Submit test results verifying gradation and that the material contains less than 1% asbestos, arsenic or cyanide by volume. Tests submitted shall be performed within sixty (60) days of the submission. All material furnished and all work performed shall be subject to inspection, and no material shall be delivered to the Project site until it has been favorably reviewed by the Engineer or used in the construction of improvements until it has been inspected in the field by the Engineer.

Engineered fill used for the Project shall be either select import engineering fill, or on-site soils with less than 3 percent organic content and with no particles greater than 4 inches in maximum dimension.

Select import engineered fill shall be inorganic, shall meet the above requirements for native material and have an Expansion Index less than 50. In addition, select import engineering fill shall meet the following particle-size gradation:

Sieve Opening	Percent Passing, by Dry Weight
4 - inch square	100
¾ - inch square	70 minimum
U.S. No. 4	60 minimum
U.S. No. 200	50 maximum

Select import engineered fill material that does not meet the above criteria shall be tested under the direction of the Engineer or inspector to determine if it has engineering properties equivalent to, or better than, the existing site materials. Samples of any proposed imported fill material shall be submitted to a Laboratory approved by the City for testing and approved prior to being brought to the site.

On-site engineered fill incorporated into the Project embankments shall be inorganic, contain no rocks greater than 4-inches in maximum dimension and be free of deleterious materials. Soils containing more than 3 percent by weight of organic material shall be considered organic.

Soil Conditioning

When the moisture content of the soil material is below that necessary for proper compaction, water shall be added until the moisture content is as specified to ensure solid bonding during the compacting process.

The Contractor should anticipate encountering excessively over-optimum (wet) soil moisture conditions during winter or spring grading, or during or following periods of rain. Wet soil can make proper compaction difficult or impossible. When the moisture content of the soil material is above that which will permit proper compaction, the Contractor shall reduce the moisture content by:

- A. Frequent spreading and mixing during warm dry weather;
- B. Mixing with drier materials;
- C. Stabilizing with aggregate, geotextile stabilization fabric, or both.
- D. Mixing with Lime, lime-flyash or cement product.

Options C and D shall be evaluated and approved by the Engineer prior to implementation.

Subgrade Preparation and Placement of Native Fill Material

After clearing and stripping of existing grasses and surface vegetation, perform subgrade scarification and compaction in the area of trail and bridge construction prior to fill placement and following clearing operations. Subgrade preparation shall include the following.

- A. Scarify to a depth of at least 6 inches;
- B. Moisture condition soil to at least 3 percentage point above the optimum moisture content.
and
- C. Compact the subgrade to at least 90 percent relative compaction.

After the subgrade soil has been moisture conditioned and compacted, place and compact acceptable fill as follows:

- D. Spread fill in loose lifts that do not exceed 8 inches in thickness;
- E. Moisture condition lifts to at least 1 percentage point above the optimum moisture content;
and
- F. Compact native and improve fill to a minimum of 90 percent relative compaction.

Engineered fill shall be placed in a series of horizontal layers not exceeding 8 inches in loose thickness, uniformly moisture-conditioned, and compacted to achieve a minimum relative compaction of 90%. Fill soils composed of sands, silty sands, and non-plastic silts shall be uniformly moisture conditioned to between 1 and 3 percentage points above the optimum moisture content. Additional fill lifts shall not be placed if the previous lift did not meet the required relative compaction or if soil conditions are not stable. Discing and/or blending may be required to uniformly moisture-condition soils used for engineered fill.

Excavation

After clearing, grubbing and stripping, on-site materials may be excavated with conventional earthwork equipment. Finished excavation may be sloped at 2H:1V (horizontal to vertical) or flatter.

MEASUREMENT AND PAYMENT

The contract unit price paid per cubic yard for **EARTHWORK** shall include full compensation for furnishing all labor, materials, tools, equipment, and incidentals, for doing all work involved in excavating and placing earth embankment material in conformance within the lines and grades shown on the Improvement Plans, for furnishing and mixing approved soil conditions, if required, to achieve compaction, for the compaction of the material or for subgrade preparation for the shaping and trimming slopes to solid material and to the lines and elevations shown on the Improvement Plans. No additional compensation shall be allowed for removing unsuitable material from the Project site. Surplus suitable and unsuitable material may be spread uniformly in the vicinity of the Project improvements and in areas not to receive embankment or as directed by the Engineer. Do not spread excess material within drainage channels or areas subject to erosion.

4-2.03 CLASS 2 AGGREGATE BASE**MATERIALS AND EXECUTION**

Aggregates shall conform to Section 26 of the 2018 State of California Standard Specifications, Class 2, for $\frac{3}{4}$ " maximum size gradation.

Subgrade areas to receive Class 2 Aggregate Base shall be compacted to not less than 90% relative compaction and prepared as specified in **Section 14-2.02 "Earthworks"** of these Special Provisions.

Place aggregate base in accordance with requirements of Section 26 of the State of California Standard Specifications and to the thickness shown on the Contract Plans. Grade and compact in maximum 4" thick layers to at least 90% of maximum density ASTM D1557.

Maintain surfacing by providing drainage, rolling, shaping, and water as necessary to maintain the surface in proper condition. Maintain sufficient moisture at the surface to prevent a dusty condition by light sprinkling with water.

Except as modified herein, the surface tolerance of aggregate base material shall comply with Section 26 of the State of California Standard Specifications. The finish surface of the aggregate surfacing when tested for uniformity of slope, shall not deviate in any point more than $\frac{3}{8}$ " from bottom of a 10 ft. straight edge laid in any direction. Maintain the surface shape, elevation and smoothness until construction of improvements is complete by blading and adding material, if required.

MEASUREMENT AND PAYMENT

CLASS 2 AGGREGATE BASE shall be paid per ton of material furnished and placed as shown on the Improvement Plans shall include full compensation for furnishing all labor, materials, tools, equipment and incidentals and for doing all work in furnishing, installing and compacting the Class 2 Aggregate Base material specified in these Specifications, as directed by the Engineer and no additional compensation shall be allowed therefor.

14-2.04 WEED BARRIER FABRIC

MATERIALS AND EXECUTION

Furnish and install, as shown on the Improvement Plans, heavy-duty, non-woven hydrophilic treated polypropylene fabric placed over level compacted Class 2 Aggregate Base trail sections. Furnish weed barrier fabric in not less than 4 foot wide by 50 foot long rolls. Overlap fabric not less than 6 inches at joints with adjoining fabric. The three-ply fabric shall have minimum 18 mil thickness. Weed barrier fabric shall be black in color, UV stabilized and provide superior light blocking capability while permitting passage of air and water. Weed barrier fabric shall be secured to the aggregate base material with ground staples furnished by the weed fabric manufacturer. Install all staples at intervals and in accordance with manufacturer’s recommendations.

Weed barrier fabric shall be Dewitt 12YR-450 12 year Weed Barrier Landscape Fabric or approved equal.

MEASUREMENT AND PAYMENT

The contract price paid per square foot of **WEED BARRIER FABRIC** shall include furnishing all labor, materials, tools and equipment required to furnish and install the weed barrier fabric in accordance with the Improvement Plans, as directed by the Engineer and in accordance with these Specifications.

Full compensation for all incidentals required to install and secure the weed barrier in place shall be considered in the price paid per square foot measured and no additional compensation shall be allowed therefor.

14-2.05 STABILIZED DECOMPOSED GRANITE

MATERIALS AND EXECUTION

The decomposed granite material shall be derived from the crushing and screening of natural friable granite.

The gradation of the decomposed granite material shall be as determined by ASTM C 136 methodology and conform to the following:

<u>Sieve Size</u>	<u>Percent Passing</u>
1/2"	100
3/8"	90-100
No. 4	50-100
No. 30	25-55
No. 100	10-20
No. 200	5-18

Sand equivalent shall be a minimum of 30 and the R-Value shall be a minimum of 70.

Material shall be sound, angular, durable stone particles, free from clay lumps, organic material, or other deleterious substances.

The decomposed granite material shall be stabilized with an organic binder and shall have a minimum swell volume of 32 ml/gm. The binder shall be incorporated with the granite fines by the use of a pug mill that includes a weight belt feeder that insures the proper ratio of binder to granite

finer. Blending with the use of a bucket loader or similar is not acceptable. The binder shall be blended at the rate of 12 lbs. per ton of granite fines.

The color of the stabilized decomposed granite material shall be gold to yellow.

Prior to installation, the Contractor shall submit to the Engineer a 3 pound sample of the stabilized decomposed granite material to be furnished together with manufacturer's / supplier's literature, test and gradation documents verifying compliance with these Special Provisions.

Excavate trail limit to the depth required so that the finished edges of decomposed granite surfacing will match adjacent grades and have a maximum cross slope of 2 percent.

Prepare the subgrade by scarifying in place materials to a minimum depth of 6 inches.

After the material has been thoroughly mixed, the subgrade shall be brought to line and grade and compacted to not less than 90% relative compaction.

Proof-roll the subgrade with heavy pneumatic-tired equipment to locate unstable areas and to identify soft pockets and areas of excess yielding. Do not proof-roll wet or saturated subgrades.

Excavate soft spots, unsatisfactory soils and areas of excessive pumping or rutting. Replace with compacted backfill or fill as directed by the Engineer.

The surface of the completed subgrade shall be bladed to a smooth and uniform texture.

The finished subgrade shall be uniform and free from deleterious debris such as organic materials, nails, stones and loose soil.

Install steel edging flush with the top of the proposed decomposed granite surfacing. Provide edging stakes per manufacturer's recommendations to secure edging in place during and after decomposed granite surfacing material installation.

Install aggregate subbase to compacted depth of 4 inches minimum. Compact to minimum of 90% relative compaction.

Compact each section of the subgrade, aggregate subbase and final finish decomposed granite surfacing materials with a one to three-ton roller or compactor. In all areas that are difficult to access with compaction equipment, hand tamping may be performed with multiple passes to achieve the required density.

Install and secure weed barrier fabric over the aggregate subbase material as specified in Section **14-2.04 "Weed Barrier Fabric"** of these Specifications.

Thoroughly water entire area so that the entire depth of material is moist. After a period of +/-6 hours compact the final lift with a 1000-3000 lb static drum roller. Allow for sufficient curing period of +/-4 days prior to use.

Final decomposed granite surface shall produce a surface smoothness within ¼ inch tolerance when measured with a 10 foot straight-edge. Finished surface shall provide a cross slope of 1% to 2%.

Thoroughly clean all areas where the work has occurred. Remove from site excess material, debris and rubbish.

Take all precautions necessary to protect completed work until Substantial Completion of Project has been issued by the Engineer.

MEASUREMENT AND PAYMENT

The contract price paid per ton of **STABILIZED DECOMPOSED GRANITE** shall include furnishing all labor, materials, tools and equipment required to furnish and install the stabilized decomposed granite trail material in accordance with the Improvement Plans, as directed by the Engineer and in accordance with these Specifications and no additional compensation shall be allowed therefor.

14-2.06 METAL TRAIL EDGING

MATERIALS AND EXECUTION

Furnish and install 8 inch deep by 10 foot long, minimum 14 gauge, Cor-Ten Weathered Steel metal trail edging together with metal steel anchors specifically supplied by the metal edging manufacturer. Anchors shall be installed, per manufacturer's recommendations, at each metal edge connection and at not more than 5 foot intervals. The top of edging shall be set flush and level to ¼ inch above top of decomposed granite surface. Contractor is directed to **Section 14-2.05 "Stabilized Decomposed Granite"** for additional construction requirements regarding construction of the trail subbase metal edging, Class 2 Aggregate Base and stabilized decomposed granite materials.

The Contractor shall submit to the City Engineer, for review and approval, shop drawings for the metal trail edging and metal edging anchors showing dimensions, gauge, connection details and manufacturer's recommended installation instructions prior to installation of the metal trail edging material.

MEASUREMENT AND PAYMENT

The contract price paid per lineal foot of **METAL TRAIL EDGING** shall include furnishing all labor, materials, tools and equipment required to furnish and install metal edging in accordance with the Improvement Plans, these Specifications and as directed by the Engineer. Full compensation for all incidentals required to install the metal trail edging including the metal edge steel anchors shall be included in the price paid per lineal foot of metal trail edging and no additional compensation shall be allowed therefor.

14-2.07 PRESSURE TREATED DOUGLAS FIR LUMBER

MATERIALS AND EXECUTION

Furnishing and placement of pressure treated lumber components of this Project shall conform to the Improvement Plans and these Special Provisions.

The Contractor shall submit product data for the pressure treated lumber including:

- Manufacturers / suppliers requirements for storage, cutting and finishing
- Pressure Treatment Certification.
- Shop Drawings for connection details, fastening, connections and dimensions.

Contractor shall furnish and supply pressure treated lumber from a single approved source. Each piece of lumber furnished shall be marked to confirm compliance with specified standard.

Furnish kiln dry material to 19 percent maximum moisture control in accordance with AWPATI, Section 7- Drying after treatment.

Pressure treated lumber shall meet the requirements of APWA standard use category UC3B and shall be suitable for decking, joints and beams.

Each piece of lumber must bear grade mark, stamp, or other identifying marks indicating grades of material and rules or standards under which it is produced. Identifying marks are to be in accordance with rule or standard under which material is produced, including requirements for qualifications and authority of the inspection organization, usage or authorized identification and information included in the identification.

Structural joists both exposed and concealed shall be Douglas Fir, Grade 1 or better.

Puncheon and bridge decking shall be Douglas Fir, Grade 1, or better.

Hardware and Adhesives

1. Screws:
 - a) Wood to Wood: ASME B18.6.1 or ASTM C1002.
 - b) Wood to Steel: ASTM C954, or ASTM C1002.
2. Joist Hangers:
 - a) Fabricated of 0.063 inch minimum thick sheet, U design unless shown otherwise.
 - b) Heavy duty hangers fabricated or minimum 0.108 inch thick sheet, U design with bent top flange to lap over beam.
3. Timber Connectors: Fabricated of steel to shapes indicated on Project Plans.
4. Joist Ties: Mild steel flats, 3/16 inch by 1¼ inch size with ends bent about 30 degrees from horizontal, and extending at least 16 inches onto framing. Punch each end for three (3) spikes.

Prior to installation of pressure treated lumber, inspect conditions to ensure surfaces are suitable for installation of decking and joist material and that adequate structural support has been provided.

Install in accordance with Improvement Plans including the following:

1. Install materials plumb, true to line, cut and fitted.
2. Scribe and cope as required for accurate fit to adjacent construction.
3. Use fasteners per the Improvement Plans.
4. Fasten tight to supports. Provide shims if there are variations in framing.

Protect decking and joists from damage during construction operations. Promptly repair any damaged surfaces. Remove and replace work which cannot be repaired to the satisfaction of the City.

MEASUREMENT AND PAYMENT

The contract price paid per board foot of 6 inch wide by 2 inch thick (nominal) **PRESSURE TREATED DOUGLAS FIR** decking shall include furnishing all labor, materials, tools and equipment required to furnish and install wood decking in accordance with the Improvement Plans, these Specifications and as directed by the Engineer. Full compensation for all incidentals, fasteners and connections required to install the wood decking shall be considered in the price paid per board foot of wood decking and no additional compensation shall be allowed therefor.

The contract unit price paid per board foot of 4 inch by 4 inch (nominal) Pressure Treated Douglas Fir Joists shall include furnishing all labor, materials, tools and equipment required to furnish and install wood joists in accordance with the Improvement Plans, these Specifications and as directed by the Engineer. Full compensation for all incidentals, fasteners, joist hangers and connections required to install the wood joists shall be considered in the price paid per board foot of wood joists and no additional compensation shall be allowed therefor.

14-2.08 PRECAST CONCRETE PIER BLOCKS

MATERIALS AND EXECUTION

Materials and execution for furnishing and placement of Precast Concrete Pier Blocks shall conform to **Section 51.4, "Precast Concrete Members"** and Section **90-2, "Minor Concrete"** of the 2018 State Standard Specifications.

The concrete mix used in constructing the precast concrete pier blocks shall be capable of attaining a minimum 28-day compressive strength of 3000 psi.

Aggregates used in the concrete mix either coarse or fine, excluding light-weight aggregates shall conform to specifications as outlined by ASTM C-33-86.

All light-weight aggregates, fine or coarse, shall conform to specification as outlined by ASTM C-330-85T.

Both types of aggregates shall be properly graded and free of any deleterious substances so as to produce a homogeneous concrete mix when blended with cement.

MEASUREMENT AND PAYMENT

The Contract unit price paid per each **PRECAST CONCRETE PIER BLOCK** shall include full compensation for furnishing all labor, materials, tools, equipment, and incidentals, for doing all the work involved in preparing and compacting the subgrade material where each pier block will be placed and securing each pier block to the pressure treated Douglas Fir wood joists as shown on the Improvement Plans, as specified in these Specifications and as directed by the City Engineer and no additional compensation shall be allowed therefor.

14-2.09 CAST IN PLACE CONCRETE BRIDGE FOOTINGS

MATERIALS AND EXECUTION

Materials

A. Concrete Materials

Except as noted below, all products and materials used in proportioning, mixing, transport, placement, consolidation, curing, and repair of cast in place concrete items shall conform with ACI 301, Specifications for Structural Concrete in Buildings, and the Improvement Plans.

1. Aggregate per ACI 301
2. Cementitious materials per ACI 301
 - a. Cement shall be Portland Cement.
 - b. Fly ash shall be provided at 15% minimum, 25% maximum of cementitious materials.
3. Admixtures
 - a. Provide as necessary to meet design and workability requirements
 - b. Mixes for hydraulic structures require shrinkage-reducing admixture, such as Eclipse by W.R. Grace are permitted.
4. The minimum 28-day strength and type of concrete shall be 3000 psi.

B. Reinforcing Steel

1. Bar reinforcement shall conform to the requirements of A 706 for Grade 60 billet Steel Reinforcement.
 - a. Accessories shall include all necessary chairs, slab bolsters, concrete blocks, tie wires, dips, supports, spacers and other devices to position reinforcement during concrete placement. All bar supports shall meet the requirements of the CRSI Manual of Standard Practice including special requirements for supporting epoxy coated reinforcing bars.

C. Water shall be potable, and have the following limitations:

1. Chlorides (as Cl) no more than 250 mg/L per EPA method 300.
2. Sulfates (as SO₄) no more than 250 mg/L per EPA method 300.
3. Total dissolved solids no more than 500 mg/L per EPA method 160.
4. Water quality shall be analyzed by EPA methods. Test results shall be provided to the Engineer of Record for the first batch of concrete, and every 500 cubic yards of fresh concrete thereafter.

D. Curing compounds per ACI 301.

Execution

- A. Precast construction shall not be commenced until concrete mix design submittals have been approved by the City.

- B. Details of the concrete reinforcement steel shall be submitted by the Contractor at the earliest possible date. Details of reinforcement steel for fabrication and erection shall conform to ACI 315. The shop bending diagrams shall show the actual lengths of bars, to the nearest inch measured to the intersection of the extensions (tangents for bars of circular cross section) of the outside surface. The shop drawings shall include bar placement diagrams that clearly indicate the dimensions of each bar splice.
- C. Reinforcing, embedded items, sleeves, and inserts shall be set and secured prior to fresh concrete placement. Interconnect anchor bolt groups with steel templates.
- D. Formwork temperature is verified per ACI 301.
- E. Subgrade to be cast against conforms to ACI 301.
- F. Reinforcement steel shall be accurately positioned and shall be supported and wired together to prevent displacement, using annealed iron wire ties or suitable clips at intersections. All reinforcement steel shall be supported by concrete, plastic or metal supports, spacers or metal hangers that are strong and rigid enough to prevent any displacement of the reinforcement steel. Where concrete is placed on the ground, supporting concrete blocks (or dobies) shall be used, in sufficient numbers to support the bars without settlement, but in no case shall such support be continuous. All concrete blocks used to support reinforcement steel shall be tied to the steel with wire ties that are embedded in the blocks. For concrete over formwork, the Contractor shall furnish concrete, metal, plastic or other acceptable bar chairs and spacers.
- G. Placement of fresh concrete in forms shall conform to ACI 301.
- H. Placement of fresh concrete on soil shall conform to ACI 301.
- I. Placement of fresh concrete shall be limited to weather constraints per ACI 301.
- J. Depositing fresh concrete per ACI 301 with the following requirements:
 - 1. For hot weather conditions, maximum time from batching to discharge shall not exceed 45 minutes.
 - 2. For normal weather conditions, maximum time from batching to discharge shall not exceed 60 minutes.
 - 3. Time between lift placement shall not exceed 30 minutes for hot weather placement; 60 minutes otherwise.
- K. Consolidate fresh concrete per ACI 301.
- L. Finishing formed surfaces
 - 1. Exposed edges shall have 5/8-inch chamfers.
- M. Broom finish shall be applied to Precast Concrete Bridge Footings.
- N. Protect bridge footings per ACI 301.

MEASUREMENT AND PAYMENT

The contract price paid per cubic yard for **CAST IN PLACE BRIDGE FOOTINGS** shall include full compensation for furnishing all labor, materials, tools and equipment and incidentals and for doing all work involved in grading, preparing and compacting subgrade material where bridge footings will be placed, furnishing and constructing formwork, furnishing and installing reinforcing steel, pouring, finishing and curing precast concrete footings ready for the placement of the modular bridge improvements as shown on the Improvement Plans, as specified in these Specifications and as directed by the City Engineer and no additional compensation shall be allowed therefor.

14-2.10 MODULAR STEEL BRIDGE

MATERIALS AND EXECUTION

(TO BE ADDED)

14-2.11 PROJECT AREA SIGNS

MATERIALS AND EXECUTION

Work shall conform to **Section 82, "Signs and Markers,"** of the 2018 State Standard Specifications, details in the State Standard Plans, and California MUTCD except as noted herein.

- A. Sign Blanks – All signs shall be 0.080 gauge, except for ground mounted street name signs which shall be 0.125-gauge, non-recycled aluminum.
- B. Mounting Hardware – All brackets, banding, buckles, nuts, washers and bolts must be stainless steel unless otherwise noted herein. (When fastening signs to brackets, use plastic or fiber washers in between the flat washer and sign face to prevent damage to sign sheeting). Damaged sheeting due to improper installation is not acceptable and will be rejected.
- C. Sign Poles and bases – A break-away system using Western Highway Ulti-Mate, 12 gauge, 1-3/4" x 1-3/4" shall be used.
- D. Sign Reflectivity – All signs must comply with the following standard.
 1. The sign face shall have white 3M diamond grade (or equal) reflective sheeting (ASTM Type III, IV, X) applied as a background.
 2. Lettering/graphics shall be one of the following:
 - a. 3M Scotchlite Electrocut (letter cutting) transparent cuttable film (1170 series) inverse cut to allow white reflective background to show through lettering.
 - b. Screen printed using 3M 8801 series color translucent ink.
 - c. Both processes (a or b) will accomplish a color field with white copy.
 - d. The sign shall include a 3M series 1160 graffiti guard.
- E. Sign Color – All new warning signs in school areas shall be fluorescent yellow green.
- F. Arm pole signs shall be mounted with skybracket or equal.

INSTALLATION

Sign Height - Project signs shall be mounted a minimum of 7'-0" above existing grade from the bottom of the sign. Height of the bottom of the sign may be adjusted higher to compensate for trail approach grade. Please refer to California MUTCD for any variation.

MEASUREMENT AND PAYMENT

The contract price paid for each **PROJECT AREA SIGN SHALL** include full compensation for removing existing sign and post, for furnishing all labor, materials, tools, equipment, and incidentals, for doing all the work involved in providing, relocating, and installing signs and posts, as shown on the Improvement Plans, as specified in these Specifications and as directed by the Engineer and no additional compensation shall be allowed, therefor.

14-2.12 REMOVABLE BOLLARDS

MATERIALS AND EXECUTION

The Contractor shall furnish and install, at each approach to the Zimpher Creek Bridge Crossing, removable bollards. Removable bollard material and construction shall conform to the details shown on the Improvement Plans and shall include concrete footings, 3 inch diameter galvanized steel sleeves embedded in concrete footings and 2 ½ inch diameter galvanized steel bollards secured to the 3 inch diameter galvanized steel sleeve with pin and padlock approved by the City Engineer. Unless otherwise directed by the Engineer, removable bollards shall be painted with 2 coats of white paint. The finished height of the removable bollards shall be 36 inches as shown in the Improvement Plans.

MEASUREMENT AND PAYMENT

The unit price paid for each **REMOVABLE BOLLARD** shall include full compensation for furnishing all labor, materials, tools, equipment, and incidentals, for doing all the work involved in excavating the bollard footings, furnishing and installing concrete, furnishing, installing and painting the galvanized steel sleeve and bollard and furnishing and installing the removable bollard hardware and appurtenances as shown on the Improvement Plans, as specified in these Specifications and as directed by the Engineer and no additional compensation shall be allowed, therefor.

14-2.13 HDPE CULVERTS

MATERIALS AND EXECUTION

Materials and execution of HDPE Culverts shall conform to **Section 64, "Plastic Pipe"**, **Section 70, "Miscellaneous Drainage Facilities"** and **Section 71, "Existing Drainage Facilities"** of the 2018 State Standard Specifications and **Section 6, "Storm Drain Standard Details"** of the City of Sebastopol Construction Drawings and Standard Specifications.

Double Wall High Density Polyethylene (HDPE) Storm Drain Pipe and Fittings shall be Type S and conform to the requirements of AASHTO M294 and Section 64 of the State Specifications except as noted herein. Joints shall be integral bell and spigot or bell / bell coupler with water tight gaskets conforming to ASTM F-477. Furnish and install HDPE Storm Drain Pipe with smooth wall interior and corrugated exterior construction.

Storm drain bedding and backfill material and placement shall conform to Section 64 of the State Standard Specifications and to the City Storm Drain Construction Drawings and Standard Specifications.

No storm drain pipe shall be placed in conditions where the Engineer determines are unsuitable.

MEASUREMENT AND PAYMENT

The contract price paid for each ± 15 foot long by 12 inch diameter **HDPE CULVERT** shall include full compensation for furnishing all labor, materials, tools, equipment, and incidentals involved and for furnishing pipe, conducting pipe excavation, placement and compaction of pipeline bedding and backfill material, all in accordance with Standard Specifications, City Storm Drain Standards, Improvement Plans, these City Specifications and as directed by the Engineer and no additional compensation shall be allowed, therefor.

DRAFT

SECTION 14-3 Special Provisions

DRAFT

IMPROVEMENT PLANS FOR CONSTRUCTION OF AMERICORPS TRAIL AND ZIMPHER CREEK BRIDGE CROSSING

CITY OF SEBASTOPOL, CALIFORNIA CITY CONTRACT NO 2022-03

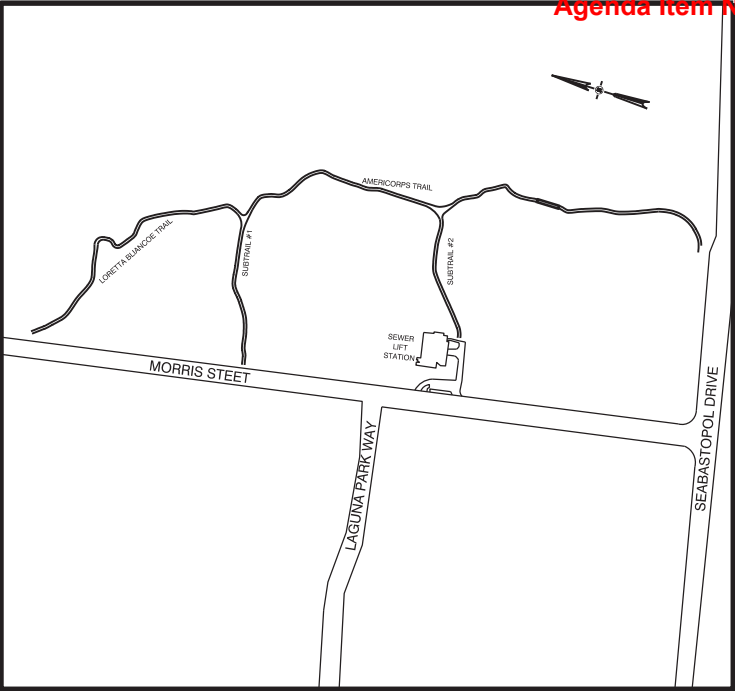

VICINITY MAP
NO SCALE

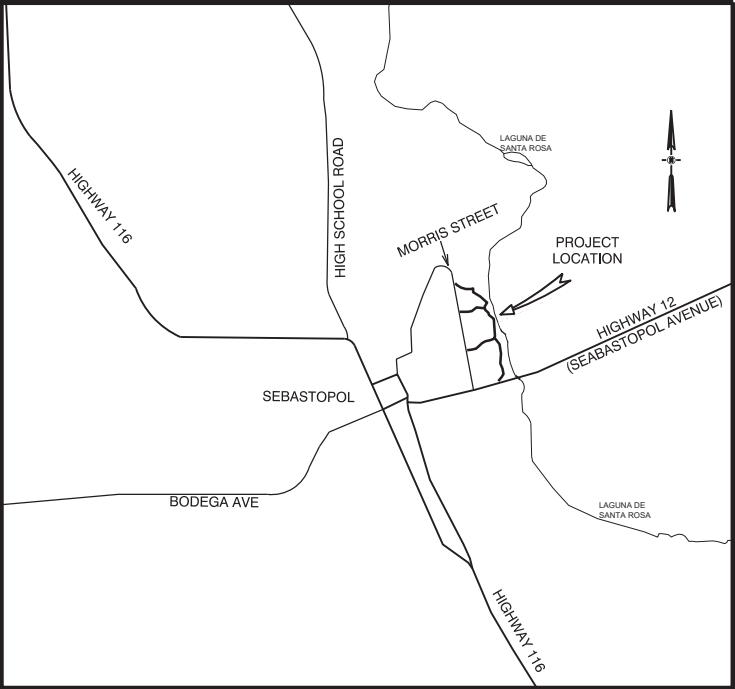

**PROJECT LOCATION
AMERICORPS TRAIL**
NO SCALE

PROJECT REPRESENTATIVES		
AGENCY	REPRESENTATIVES	PHONE
CITY ENGINEER	MARIO LANDEROS	(707) 236-1542
PROJECT ENGINEER	KASL CONSULTING ENGINEERS	(916) 722-1800
PG&E GAS	STEVE WILLIS	(707)-579-6189
U.S.A. NORTH		(800) 227-2600
		or (800) 642-2444

ABREVIATIONS

STA.	STATION
D.I.	DROP INLET
MH.	MANHOLE
PUE	PUBLIC UTILITY EASEMENT
EP	EDGE OF PAVEMENT
CL	CENTER LINE
R/W	RIGHT OF WAY
PL	PROPERTY LINE
C.	CONCRETE
IRR.	IRRIGATION
MTRS	METERS
WV	WATER VALVE
ACP	ASBESTOS CEMENT PIPE
F.H.	FIRE HYDRANT
S.	SIGN
CMP	CORRIGATED METAL PIPE
T(UG)	TELEPHONE (UNDER GROUND)
TEL.	TELEPHONE
PED.	PEDESTAL
E(UG)	ELECTRICAL LINE (UNDER GROUND)
E(OH)	ELECTRICAL LINE (OVERHEAD)
JP	JOINT POLE
G	GAS LINE
SD	STORM DRAIN
W	WATER LINE
SS	SANITARY SEWER
RWD	REDWOOD TREE
ASPH	ASPHALT PAVING
SSCO	SANITARY SEWER CLEANOUT
BC	BEGIN CURVE
EC	END CURVE
PI	POINT OF INTERSECTION
BVC	BEGIN VERTICAL CURVE
EVC	END VERTICAL CURVE
SSMH	SANITARY SEWER MAN HOLE

CALL
UNDERGROUND
SERVICE ALERT
1-800-642-2444
AT LEAST 48 HOURS
PRIOR TO EXCAVATION

INDEX OF SHEETS

1. TITLE SHEET
2. LAYOUT PLAN
3. PLAN & PROFILE - MAIN TRAIL STA 1+00 TO 4+00
4. PLAN & PROFILE - MAIN TRAIL STA 4+00 TO 9+00
5. PLAN & PROFILE - MAIN TRAIL STA 9+00 TO 14+00
6. PLAN & PROFILE - MAIN TRAIL STA 14+00 TO 19+00
7. PLAN & PROFILE - MAIN TRAIL STA 19+00 TO 22+00
8. PLAN & PROFILE - SUBTRAIL #1
9. PLAN & PROFILE - SUBTRAIL #2
10. TYPICAL SECTIONS
- S1. STRUCTURAL - GENERAL NOTES
- S2. STRUCTURAL - BRIDGE ABUTMENT
- S3. STRUCTURAL - PUNCHEON DECK

<p>PROJECT ENGINEER KASL CONSULTING ENGINEERS 7777 GREENBACK LANE, SUITE 104 CITRUS HEIGHTS, CA 95610 916-722-1800</p>	<p>STRUCTURAL ENGINEER VE SOLUTIONS 7777 GREENBACK LANE, SUITE 104 CITRUS HEIGHTS, CA 95610 916-505-0519</p>
---	---

CONVENTIONAL SIGNS

	EXISTING	PROPOSED
CENTERLINE	---	---
RIGHT OF WAY	---	---
LOT LINE	---	---
EASEMENT	---	---
EDGE OF PAVEMENT	---	---
EDGE OF SHOULDER	---	---
CURB-GUTTER & SIDEWALK	---	---
CONTOUR	~125~	~125~
FLOW LINE	---	---
WATER MAIN	10" W	10" W
SEWER MAIN	8"SS	8"SS
STORM DRAIN	12"SD	12"SD
SEWER SERVICE	4"SS	4"SS
SEWER SERVICE	4"SS	4"SS
SEWER SERVICE	4"SS	4"SS
FIRE HYDRANT	---	---
WATER SERVICE	---	---
WATER VALVE & BOX	---	---
DRAIN DROP INLET	---	---
GAS MAIN	2"G	2"G
GAS SERVICE	3/4"GS	3/4"GS
TELEPHONE	T(UG)	T(UG)
ELECTRICITY	E(UG)	E(UG)
TELEVISION	CATV(UG)	CATV(UG)
FENCE	---	---
GUY WIRE & ANCHOR	---	---
STREET LIGHT	---	---
UTILITY POLE	---	---
PULL BOX	---	---
CONTROL PEDESTAL	---	---

CITY OF SEBASTOPOL

APPROVED BY:

MARIO LANDEROS, CITY ENGINEER CITY OF SEBASTOPOL	DATE
---	------

REVISIONS

NO.	DESCRIPTION	DATE

SCALE: N.A.	RELEASE 2
JOB NO. 6840-05	DATE: FEB 2023



IMPROVEMENT PLANS FOR CONSTRUCTION OF
**AMERICORPS TRAIL AND ZIMPHER
 CREEK BRIDGE CROSSING**
 CITY OF SEBASTOPOL
TITLE SHEET

CONSULTING ENGINEERS
KASL
 ENGINEERS
 CIVIL - WATER RESOURCES - SURVEYING

7777 Greenback Lane
 Suite 104
 Citrus Heights, CA 95610
 Tel: (916) 722-1800
 Fax: (916) 722-4595

FILE: S:\184030 - Americorps Trail\Plan\01 TITLE.dgn
 DATE: 02/02/23 10:40:00 AM
 USER: M.LANDEROS
 PLOT: 02/02/23 10:40:00 AM
 PLOTTER: HP DesignJet 5000



0' 20' 40' 80' 160'
SCALE 1"=80' (22"x34" PLAN SHEETS)

SHEET NO.	TRAIL NAME
3	MAIN TRAIL
4	MAIN TRAIL
5	MAIN TRAIL
6	MAIN TRAIL
7	MAIN TRAIL
8	SUBTRAIL #1
9	SUBTRAIL #2
10	TYPICAL SECTIONS

NO.	REVISIONS	DESCRIPTION	DATE

SCALE: 1"=80'	RELEASE 2
JOB NO. 6840-05	DATE: FEB 2023

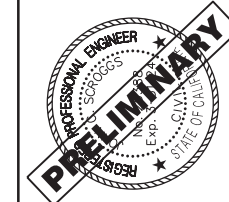

IMPROVEMENT PLANS FOR CONSTRUCTION OF
**AMERICORPS TRAIL AND ZIMPHER
CREET BRIDGE CROSSING**
CITY OF SEBASTOPOL

LAYOUT PLAN

KASL
ENGINEERS
CONSULTING
7777 Greenback Lane
Suite 104
Citrus Heights, CA 95610
Tel: (916) 722-1800
Fax: (916) 722-4595
CIVIL - WATER RESOURCES - SURVEYING

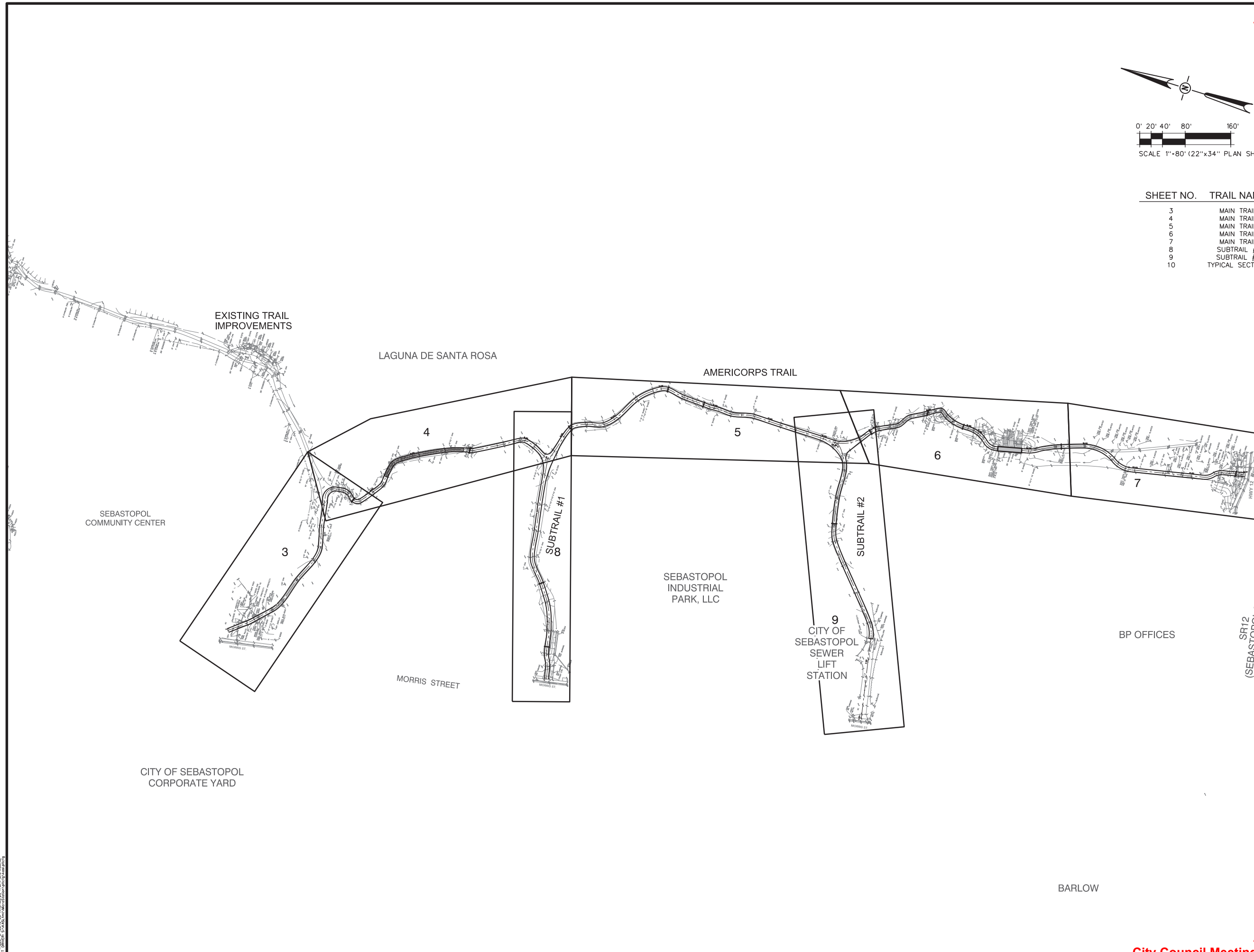

FILE: S:\6840-05_Americorps Trail\Plan\02_LAYOUT_PLAN.dgn
DATE: 02/01/2023 10:00 AM
DRAWN BY: SPENCER SPOTT
CHECKED BY: SPENCER SPOTT

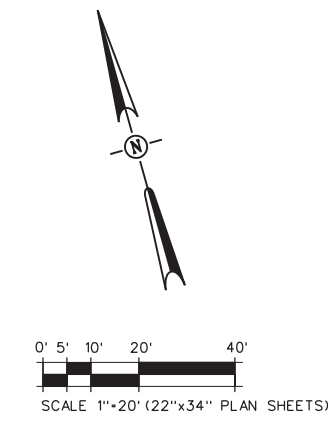
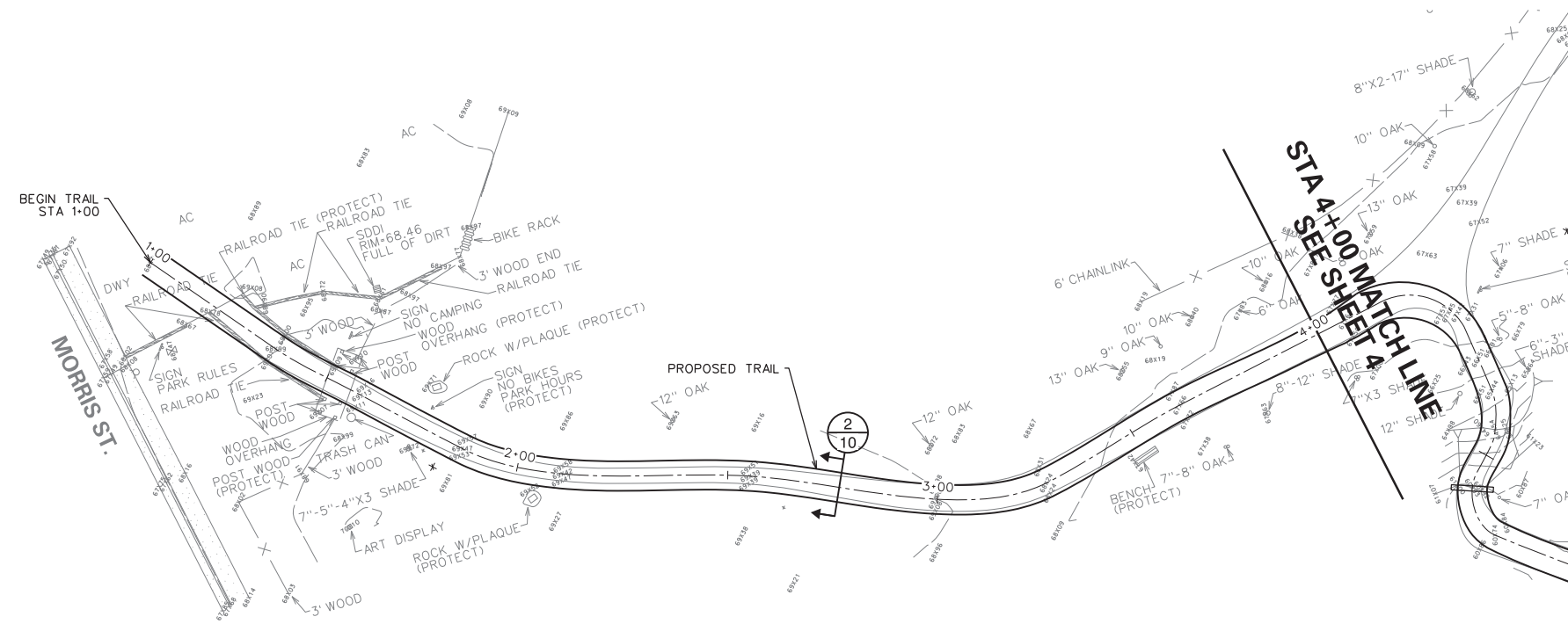

AMERICORPS TRAIL *TRIM EXISTING VEGETATION CLEAR OF PROPOSED TRAIL

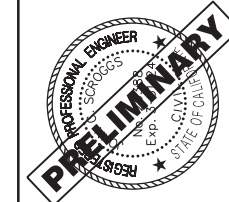
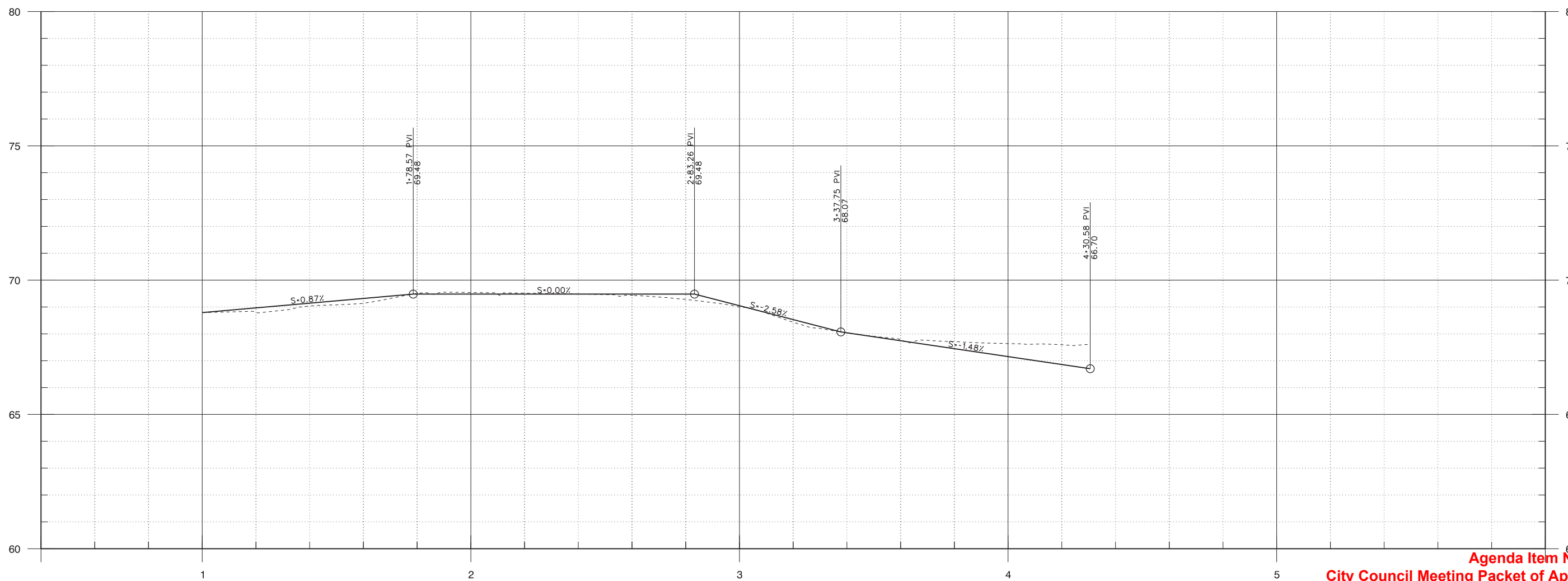

IMPROVEMENT PLANS FOR CONSTRUCTION OF
**AMERICORPS TRAIL AND ZIMPHER
 CREEK BRIDGE CROSSING**
 CITY OF SEBASTOPOL

**PLAN & PROFILE - MAIN TRAIL
 STA 1+00 TO 4+00**

KASL
 CONSULTING ENGINEERS
 7777 Greenback Lane
 Suite 104
 Citrus Heights, CA 95610
 Tel: (916) 722-1800
 Fax: (916) 722-4595
 CIVIL - WATER RESOURCES - SURVEYING

NO.	REVISIONS DESCRIPTION	DATE

SCALE:	RELEASE 2	DATE: FEB 2023
JOB NO. 6840-05		

FILE: S:\6840-05_Americorps Trail\Plan\03_Main Trail_Top.dwg
 PLOT: 11/16/2022 10:40:00 AM
 PLOTTER: HP DesignJet 5000 Series Plotter
 PLOT SCALE: 1"=20'

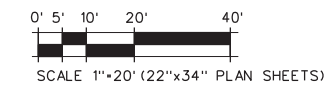
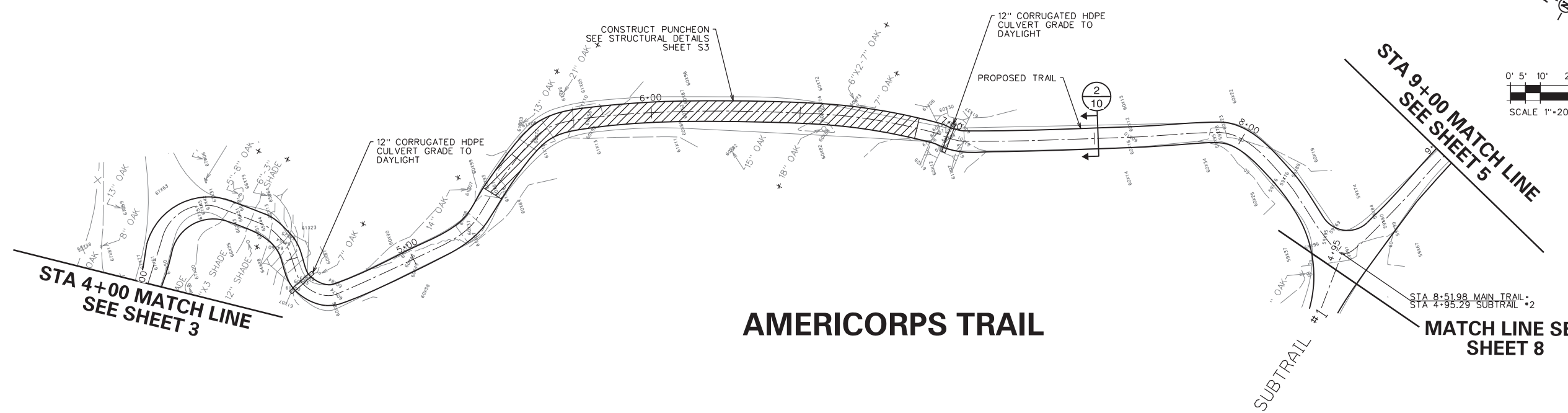

AMERICORPS TRAIL

* TRIM EXISTING VEGETATION CLEAR OF PROPOSED TRAIL

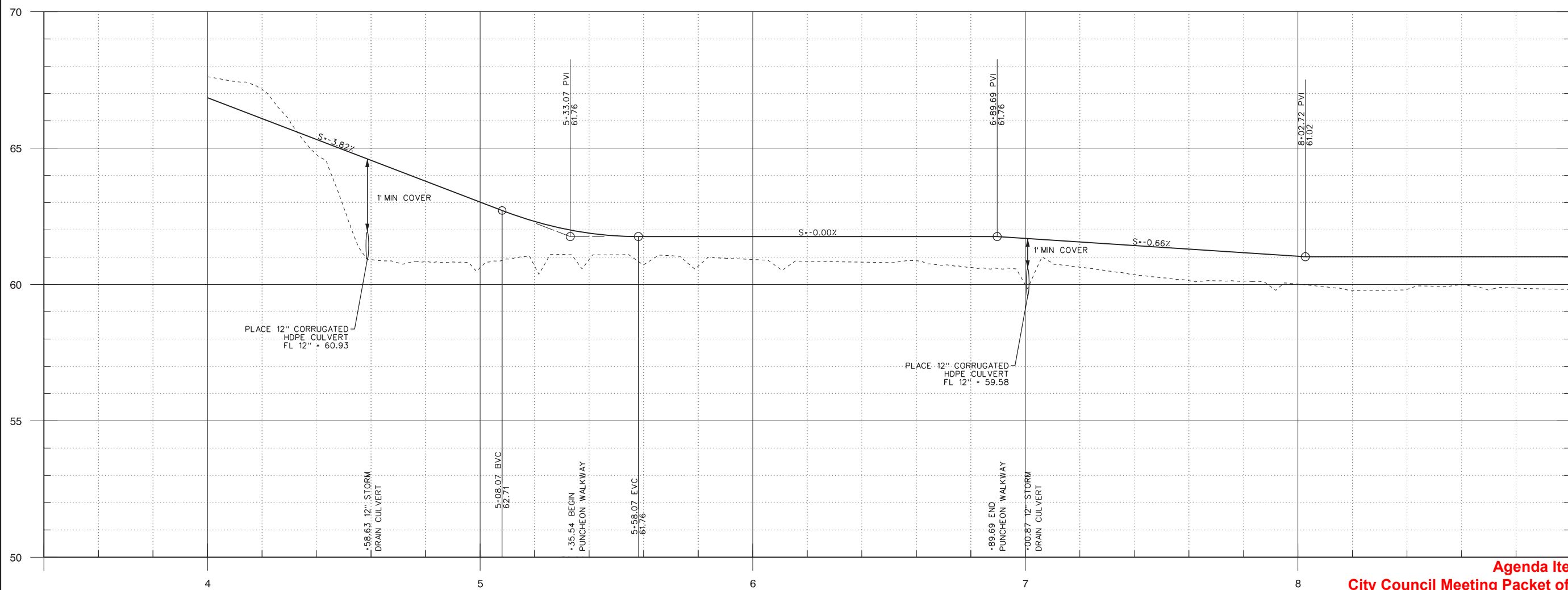

NO.	REVISIONS	DESCRIPTION	DATE

SCALE:	RELEASE 2	DATE:	FEB 2023
JOB NO. 6840-05			

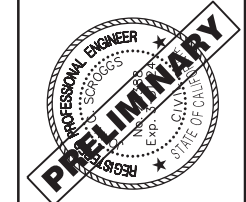

IMPROVEMENT PLANS FOR CONSTRUCTION OF
AMERICORPS TRAIL AND ZIMPHER CREEK BRIDGE CROSSING
 CITY OF SEBASTOPOL
PLAN & PROFILE - MAIN TRAIL STA 4+00 TO 9+00

KASL CONSULTING ENGINEERS
 CIVIL - WATER RESOURCES - SURVEYING
 7777 Greenback Lane
 Suite 104
 Citrus Heights, CA 95610
 Tel: (916) 722-1800
 Fax: (916) 722-4585

FILE: S:\6840-05 Americorps Trail\Plan\04 Main Trail_2.dgn
 PLOT: 1/24/23 10:40:00 AM
 PLOTTER: HP DesignJet 5000 Series
 PLOT SCALE: 1/4" = 1'

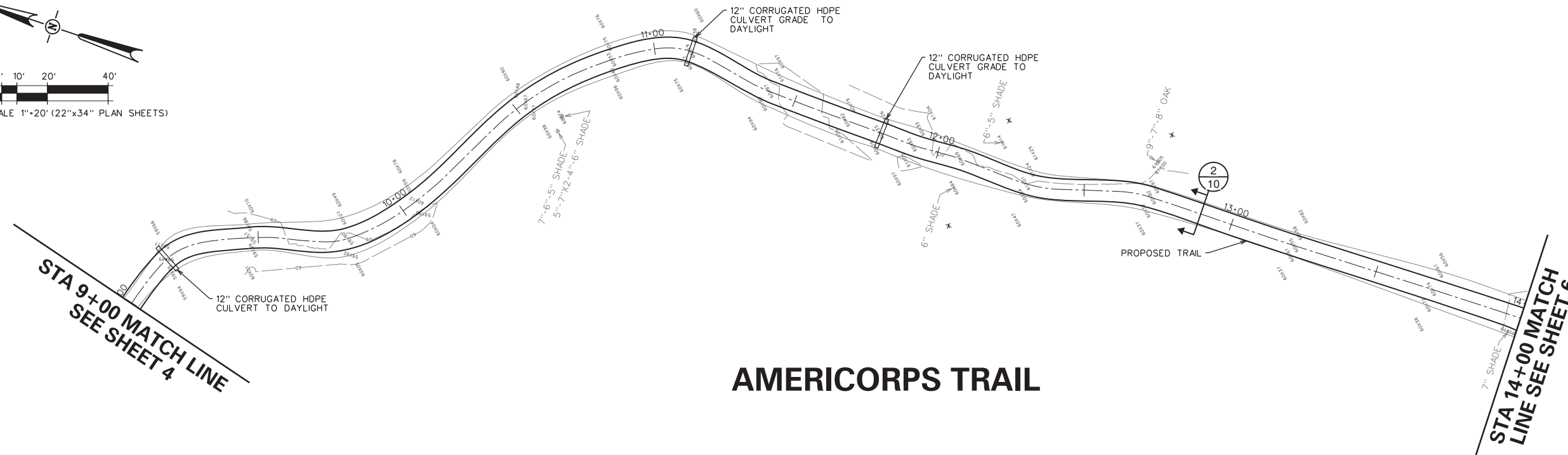
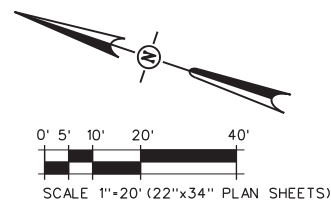

AMERICORPS TRAIL

* TRIM EXISTING VEGETATION CLEAR OF PROPOSED TRAIL

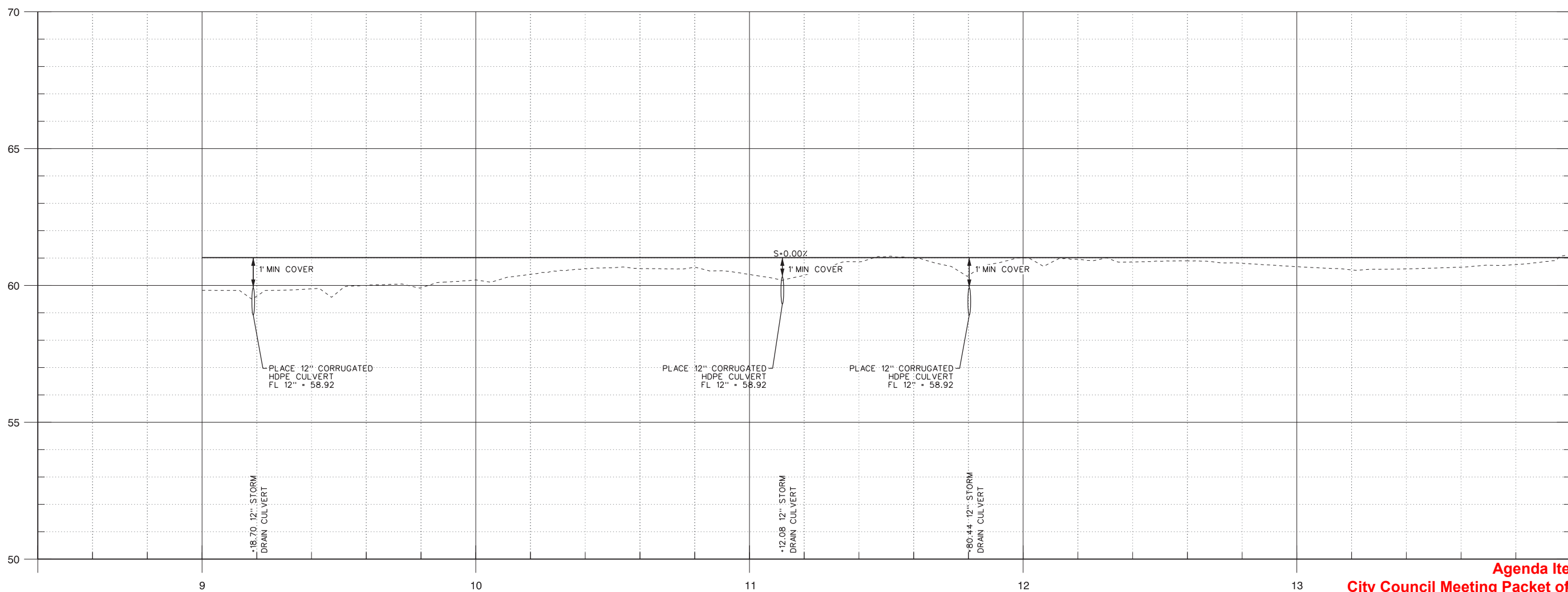

NO.	REVISIONS DESCRIPTION	DATE

SCALE:	RELEASE 2
JOB NO. 6840-05	DATE: FEB 2023

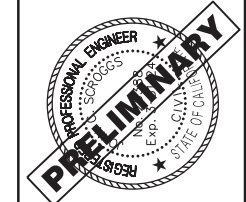

IMPROVEMENT PLANS FOR CONSTRUCTION OF
**AMERICORPS TRAIL AND ZIMPHER
 CREEK BRIDGE CROSSING**
 CITY OF SEBASTOPOL

**PLAN & PROFILE - AMERICORPS
 TRAIL STA 9+00 TO 14+00**

KASL
 ENGINEERS
 CONSULTING

7777 Greenback Lane
 Suite 104
 Citrus Heights, CA 95610
 Tel: (916) 722-1800
 Fax: (916) 722-4585

FILE: S:\184005 - Americorps Trail\Plan\05 MAIN TRAIL.dwg
 PLOT: 184005 - Americorps Trail\Plan\05 MAIN TRAIL.dwg
 PLOT DATE: 2/23/23 10:50:00 AM
 PLOT BY: Robert Spoggs

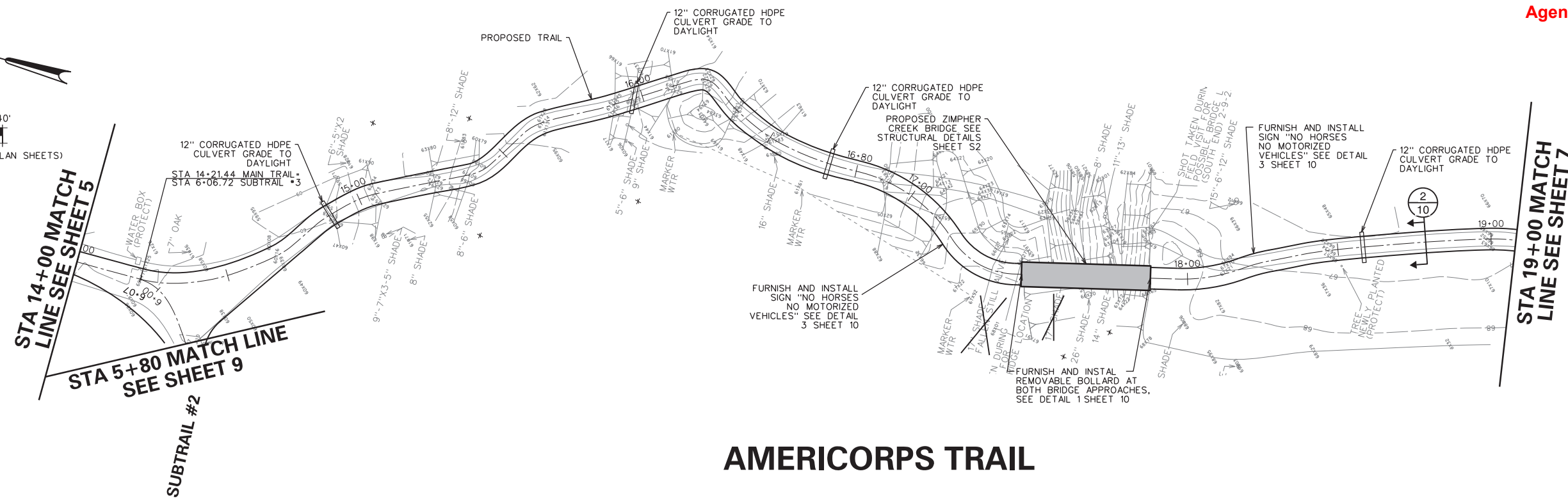
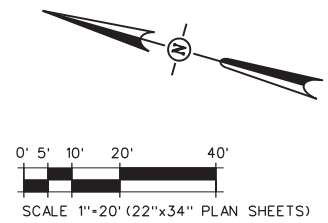

AMERICORPS TRAIL

✖ TRIM EXISTING VEGETATION CLEAR OF PROPOSED TRAIL
 ✕ REMOVE EXISTING VEGETATION CLEAR OF EXISTING TRAIL

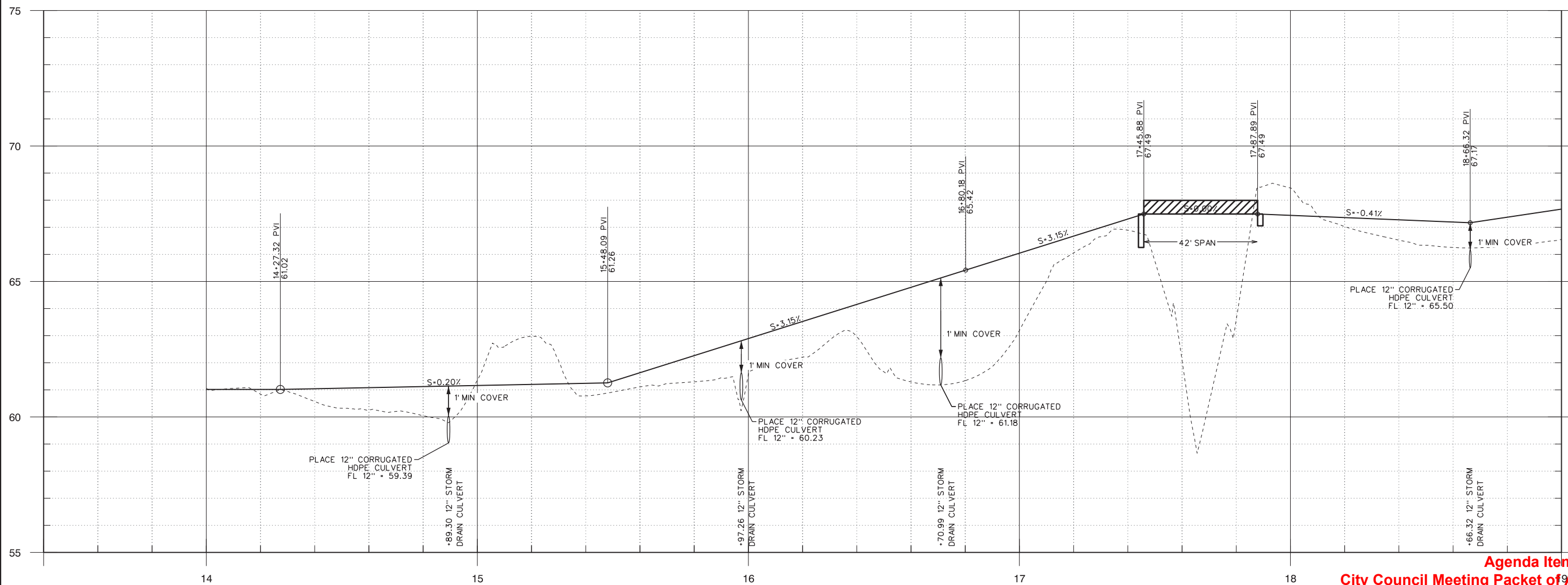

NO.	REVISIONS	DESCRIPTION	DATE

SCALE:	RELEASE 2	DATE:	FEB 2023
JOB NO. 6840-05			

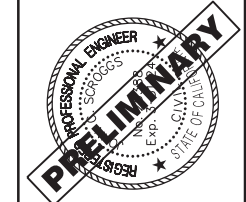

IMPROVEMENT PLANS FOR CONSTRUCTION OF
AMERICORPS TRAIL AND ZIMPER CREEK BRIDGE CROSSING
 CITY OF SEBASTOPOL
PLAN & PROFILE - AMERICORPS TRAIL STA 14+00 TO 19+00

KASL ENGINEERS
 CONSULTING ENGINEERS
 7777 Greenback Lane
 Suite 104
 Citrus Heights, CA 95610
 Tel: (916) 722-1800
 Fax: (916) 722-4585
 CIVIL - WATER RESOURCES - SURVEYING

FILE: S:\184000_Americorps Trail\Plan\06 MAIN TRAIL.dwg
 PLOT: 1/23/23 10:40:00 AM
 PLOTTER: HP DesignJet 5000
 PLOT SCALE: 1/2"=1'-0"

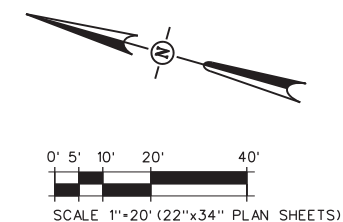
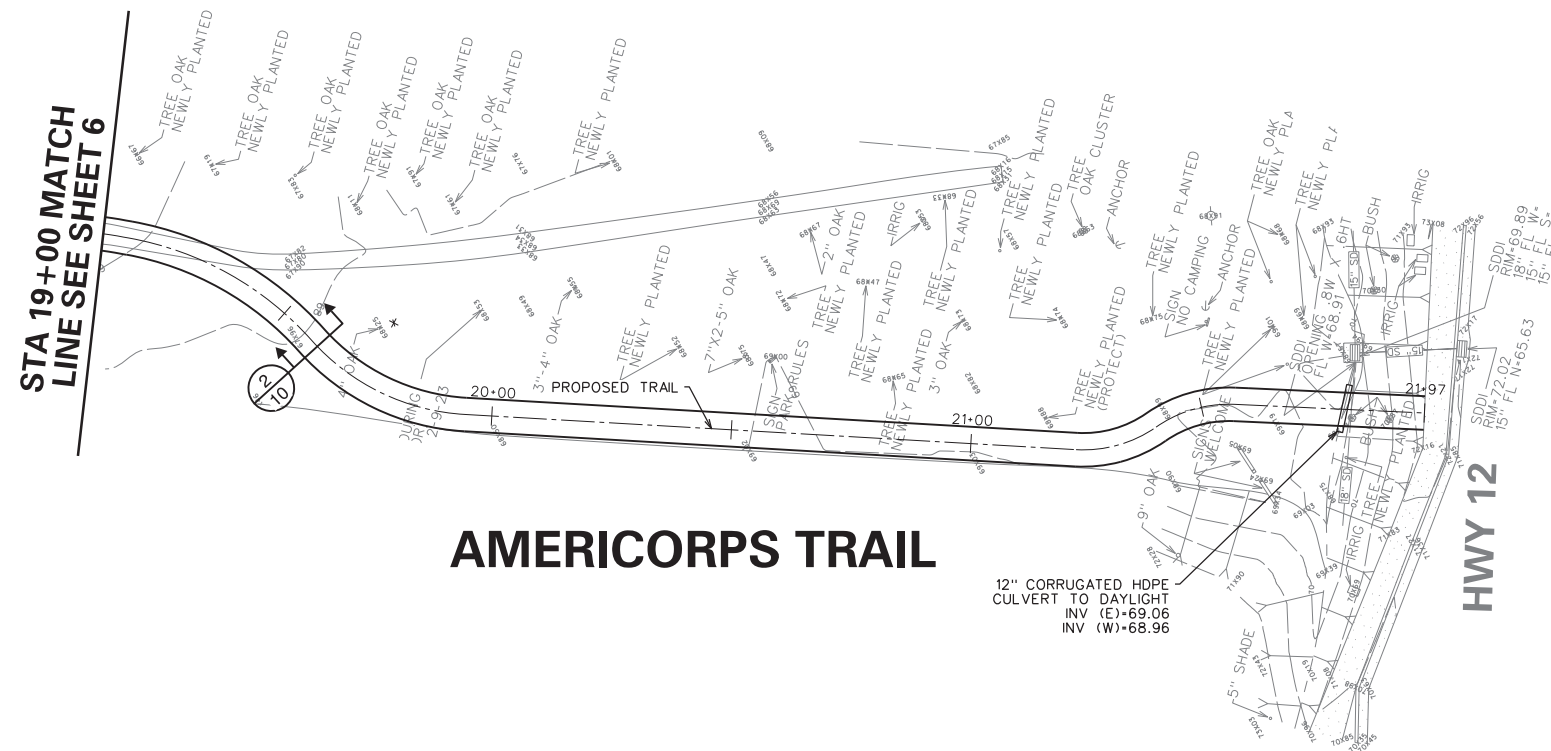

AMERICORPS TRAIL

12" CORRUGATED HDPE
CULVERT TO DAYLIGHT
INV (E)-69.06
INV (W)-68.96

* TRIM EXISTING VEGETATION CLEAR OF PROPOSED TRAIL

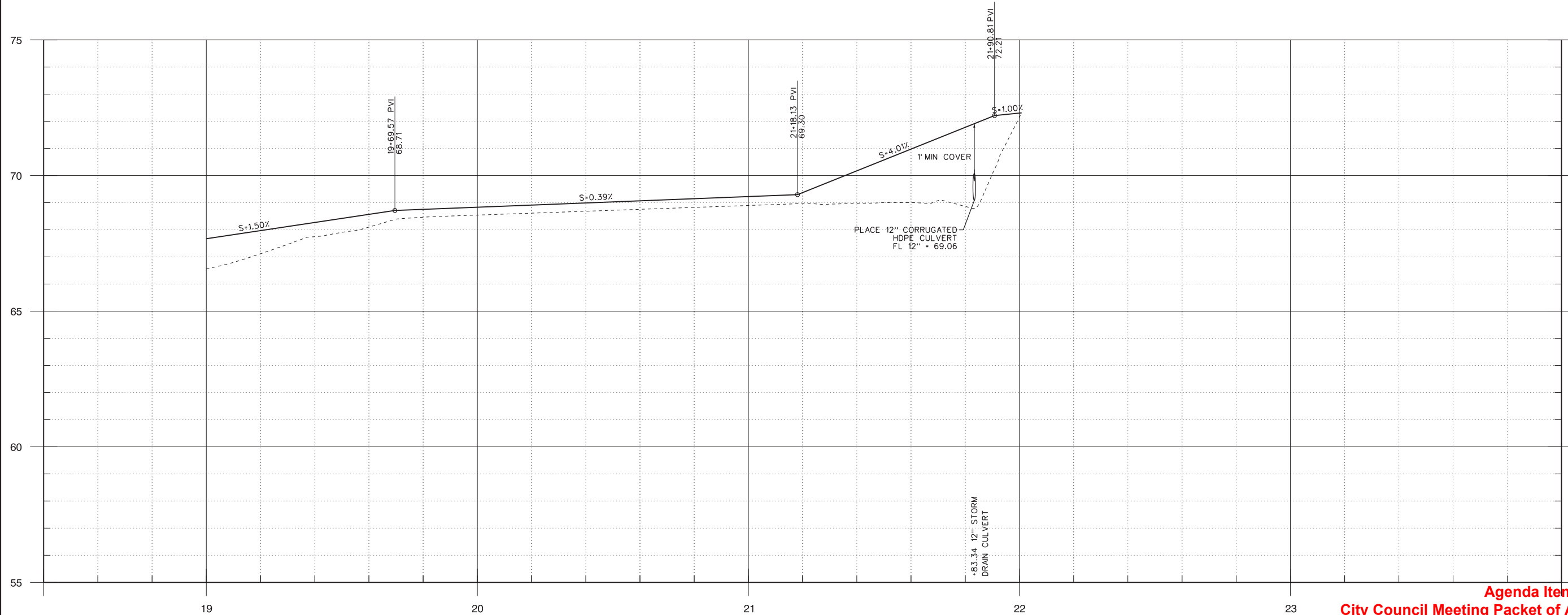

NO.	REVISIONS	DESCRIPTION	DATE

SCALE:	RELEASE 2
JOB NO. 6840-05	DATE: FEB 2023



IMPROVEMENT PLANS FOR CONSTRUCTION OF
**AMERICORPS TRAIL AND ZIMPHER
CREET BRIDGE CROSSING**
CITY OF SEBASTOPOL

**PLAN & PROFILE - AMERICORPS
TRAIL STA 19+00 TO 22+22**

KASL
ENGINEERS
CONSULTING
7777 Greenback Lane
Suite 104
Citrus Heights, CA 95610
Tel: (916) 722-1800
Fax: (916) 722-4595
CIVIL - WATER RESOURCES - SURVEYING

FILE: S:\M4000 - Americorps Trail\Plan\07 MM Trail.dwg
DATE: 12/15/2021 10:00 AM
DRAWN: S:\M4000 - Americorps Trail\Plan\07 MM Trail.dwg
PLOT: 12/15/2021 10:00 AM

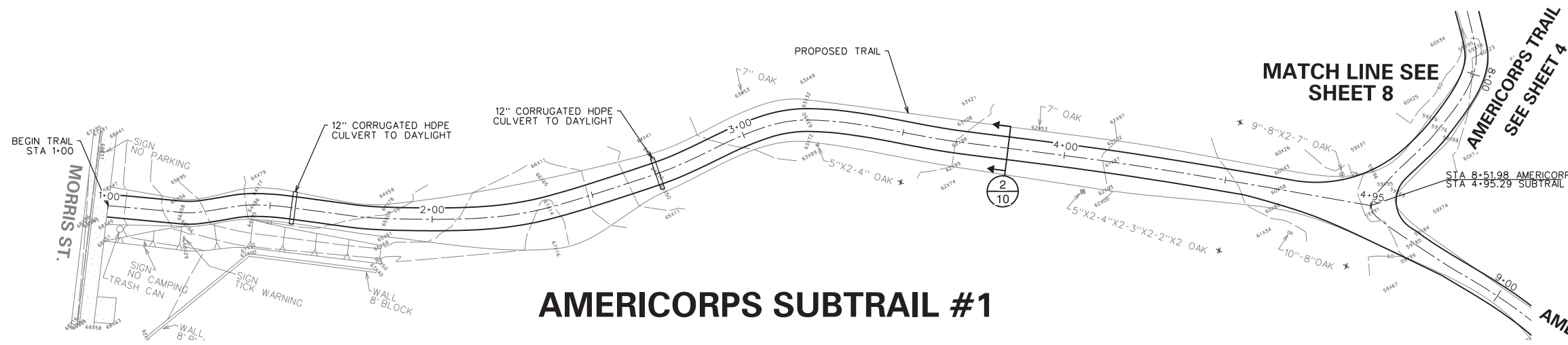

AMERICORPS SUBTRAIL #1

* TRIM EXISTING VEGETATION CLEAR OF PROPOSED TRAIL

STA 9+00 MATCH LINE SEE SHEET 5

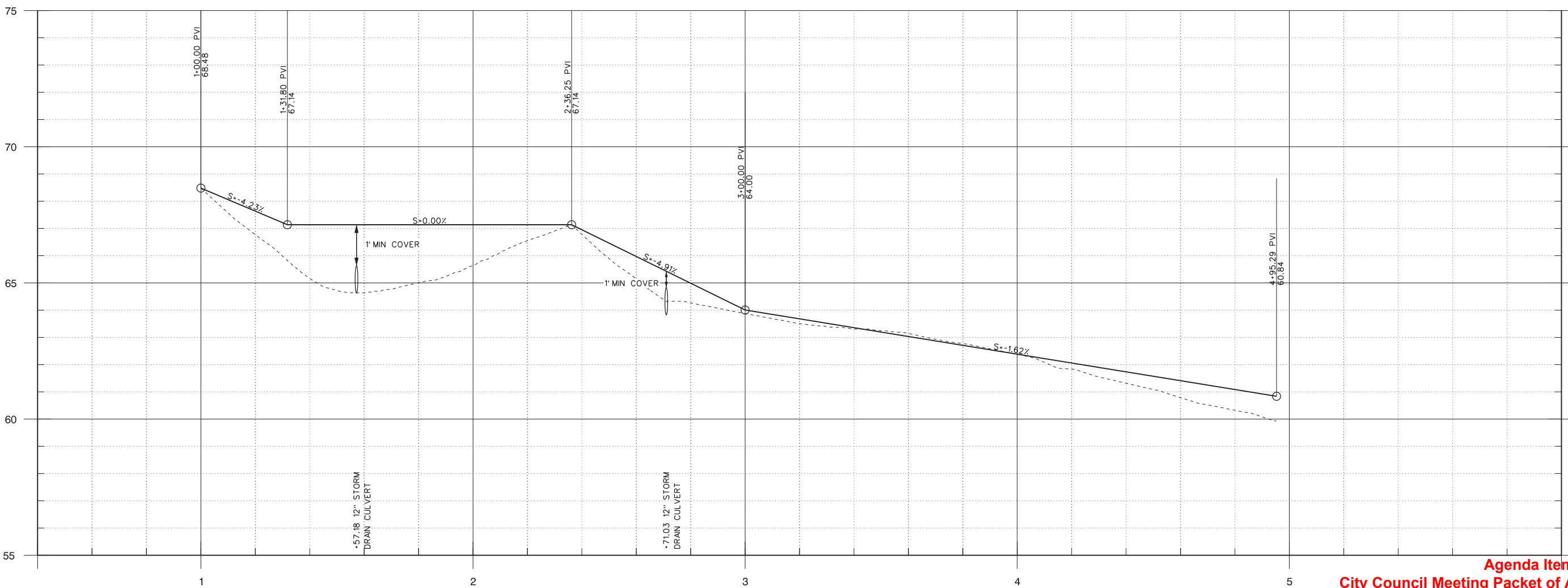

NO.	REVISIONS	DESCRIPTION	DATE

SCALE:	RELEASE 2
JOB NO. 6840-05	DATE: FEB 2023

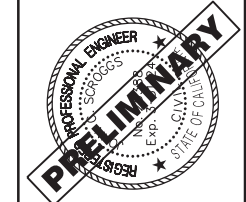

IMPROVEMENT PLANS FOR CONSTRUCTION OF
**AMERICORPS TRAIL AND ZIMPHER
 CREEK BRIDGE CROSSING**
 CITY OF SEBASTOPOL

PLAN & PROFILE - SUBTRAIL #1

KASL
 ENGINEERS
 CONSULTING

7777 Greenback Lane
 Suite 104
 Citrus Heights, CA 95610
 Tel: (916) 722-1800
 Fax: (916) 722-4585

CIVIL - WATER RESOURCES - SURVEYING

FILE: S:\184000_Americorps Trail\Plan\08 SUBTRAIL 1.dwg
 DATE: 1/26/23 10:40:00 AM
 USER: RSP
 PLOT: 1/26/23 10:40:00 AM
 PLOTTER: HP DesignJet 5000

GENERAL:

1. INTERPRETATION OF DRAWINGS & SPECIFICATIONS
 - 1.1 WHERE APPLICABLE, SPECIFICATIONS HAVE BEEN PREPARED FOR THIS PROJECT AND ARE ARRANGED IN SEVERAL SECTIONS, BUT SUCH SEPARATION SHALL NOT BE CONSIDERED AS THE LIMITS OF THE WORK REQUIRED BY ANY SEPARATE TRADE. THE TERMS AND CONDITIONS OF SUCH LIMITATIONS ARE WHOLLY BETWEEN THE CONTRACTOR AND SUBCONTRACTORS.
 - 1.2 IN GENERAL, THE WORKING DETAILS WILL INDICATE DIMENSIONS, POSITIONS AND KIND OF CONSTRUCTION, AND THE SPECIFICATIONS WILL INDICATE QUALITIES AND METHODS. ANY WORK INDICATED ON THE WORKING DETAILS MENTIONED BUT NOT IN THE SPECIFICATIONS, OR VICE VERSA, SHALL BE FURNISHED AS THOUGH FULLY SET FORTH IN BOTH. WORK NOT PARTICULARLY DETAILED, MARKED OR SPECIFIED, SHALL BE THE SAME AS SIMILAR PARTS THAT ARE DETAILED, MARKED OR SPECIFIED. IF CONFLICTS OCCUR BETWEEN DRAWINGS AND SPECIFICATIONS, THE MOST EXPENSIVE MATERIALS OR METHODS WILL PREVAIL.
 - 1.3 SHOULD AN ERROR APPEAR IN THE WORKING DETAILS OR SPECIFICATIONS OR IN WORK DONE BY OTHERS AFFECTING THIS WORK, THE CONTRACTOR SHALL NOTIFY THE ENGINEER AT ONCE AND IN WRITING. IF THE CONTRACTOR PROCEEDS WITH THE WORK SO AFFECTED WITHOUT HAVING GIVEN SUCH WRITTEN NOTICE AND WITHOUT RECEIVING THE NECESSARY APPROVAL, DECISION OR INSTRUCTION IN WRITING FROM THE OWNER, THEN THEY SHALL HAVE NO VALID CLAIM AGAINST THE OWNER, FOR THE COST OF SO PROCEEDING AND SHALL MAKE GOOD ANY RESULTING DAMAGE OR DEFECT. NO VERBAL APPROVAL, DECISION, OR INSTRUCTION SHALL BE VALID OR BE THE BASIS FOR ANY CLAIM AGAINST THE OWNER, ITS OFFICERS, EMPLOYEES, OR AGENTS. THE FOREGOING INCLUDES TYPICAL ERRORS IN THE SPECIFICATIONS OR NOTATIONAL ERRORS IN THE WORKING DETAILS WHERE THE INTERPRETATION IS DOUBTFUL OR WHERE THE ERROR IS SUFFICIENTLY APPARENT AS TO PLACE A REASONABLY PRUDENT CONTRACTOR ON NOTICE THAT, SHOULD THEY ELECT TO PROCEED, THEY ARE DOING SO AT THEIR OWN RISK.
2. CONSTRUCTION SHALL CONFORM TO THE 2022 CBC AND ALL APPLICABLE CODES AND REGULATIONS.
3. SHOP DRAWING NOTE:
 - 3.1 SHOP DRAWINGS SHALL BE SUBMITTED ELECTRONICALLY IN PDF FORMAT AT FULL SCALE.
 - 3.2 THE PURPOSE OF SHOP DRAWING SUBMITTALS BY THE CONTRACTOR IS TO DEMONSTRATE TO THE STRUCTURAL ENGINEER THAT THEY UNDERSTAND THE DESIGN CONCEPT BY INDICATING WHICH MATERIALS THEY INTEND TO FURNISH AND INSTALL, AND BY DETAILING THE FABRICATION AND INSTALLATION METHODS THEY INTEND TO USE.
 - 3.3 PRIOR TO FABRICATION, SHOP DRAWINGS SHALL BE SUBMITTED FOR REVIEW TO THE STRUCTURAL ENGINEER. SHOP DRAWING SUBMITTALS SHALL INCLUDE, BUT ARE NOT NECESSARILY LIMITED TO CONCRETE MIX DESIGNS, STRUCTURAL STEEL, REINFORCING STEEL, MASONRY UNITS, GROUT MIX DESIGNS, GLUED LAMINATED BEAMS, AND PRE-FABRICATED WOOD ROOF FRAMING ITEMS SUCH AS I-JOISTS AND TRUSSES WHERE THESE ELEMENTS ARE INDICATED ON THE DRAWINGS.
 - 3.4 PRIOR TO SUBMISSION THE CONTRACTOR SHALL REVIEW ALL SUBMITTALS FOR CONFORMANCE WITH THE CONTRACT DOCUMENTS AND SHALL STAMP SUBMITTALS AS BEING "REVIEWED FOR CONFORMANCE"
 - 3.5 SHOP DRAWING SUBMITTALS PROCESSED BY THE STRUCTURAL ENGINEER ARE NOT CHANGE ORDERS.
 - 3.6 ANY DETAIL ON THE SHOP DRAWING THAT DEVIATES FROM THE CONTRACT DOCUMENTS SHALL CLEARLY BE MARKED WITH THE NOTE "THIS IS A CHANGE".
 - 3.7 SHOP DRAWINGS OR CALCULATIONS SUBMITTED FOR REVIEW THAT REQUIRE RESUBMITTAL FOR RE-REVIEW SHALL BE BILLED HOURLY FOR SUCH TIME TO THE GENERAL CONTRACTOR. RE-REVIEW WILL NOT PROCEED WITHOUT WRITTEN APPROVAL FROM THE GENERAL CONTRACTOR FOR ADDITIONAL ENGINEERING REVIEW SERVICES.
4. SAFETY NOTE:
 - 4.1 IT IS THE CONTRACTORS RESPONSIBILITY TO COMPLY WITH THE PERTINENT SECTIONS, AS THEY APPLY TO THIS PROJECT, OF THE "CONSTRUCTION SAFETY ORDERS" ISSUED BY THE STATE OF CALIFORNIA LATEST EDITION, AND ALL OSHA REQUIREMENTS.
 - 4.2 THE OWNER AND THE STRUCTURAL ENGINEER DO NOT ACCEPT ANY RESPONSIBILITY FOR THE CONTRACTOR'S FAILURE TO COMPLY WITH THESE REQUIREMENTS.
 - 4.3 THE CONTRACTOR SHALL BE RESPONSIBLE FOR ADEQUATE DESIGN AND CONSTRUCTION OF ALL FORMS AND SHORING REQUIRED.
5. THE CONTRACTOR SHALL NOTIFY THE STRUCTURAL ENGINEER WHERE A CONFLICT OR A DISCREPANCY OCCURS BETWEEN THE STRUCTURAL DRAWINGS AND ANY OTHER PORTION OF THE CONTRACT DOCUMENTS OR EXISTING FIELD CONDITIONS. SUCH NOTIFICATION SHALL BE GIVEN IN DUE TIME SO AS NOT TO AFFECT THE CONSTRUCTION SCHEDULE. CONTRACTOR SHALL VERIFY ALL DIMENSIONS WITH STRUCTURAL DRAWINGS PRIOR TO COMMENCING ANY WORK.
6. WHERE NO SPECIFIC DETAIL IS SHOWN, THE CONSTRUCTION SHALL BE IDENTICAL OR SIMILAR TO THAT INDICATED FOR LIKE CASES OF CONSTRUCTION ON THIS PROJECT. SHOULD THERE BE ANY QUESTION, CONTACT THE STRUCTURAL ENGINEER PRIOR TO PROCEEDING.
7. WHEN CONSTRUCTION ATTACHES TO AN EXISTING BUILDING, A COMPLETE SET OF DRAWINGS OF THE EXISTING BUILDING SHALL BE KEPT ON THE JOB SITE. CONTRACTOR TO OBTAIN THESE DRAWINGS FROM THE OWNER.
8. ANY SUBSTITUTIONS FOR STRUCTURAL MEMBERS, HARDWARE, OR DETAILS SHALL BE REVIEWED BY THE STRUCTURAL ENGINEER. SUCH REVIEW WILL BE BILLED ON A TIME AND MATERIALS BASIS TO THE GENERAL CONTRACTOR WITH NO GUARANTEE THAT THE SUBSTITUTION WILL BE ALLOWED.
9. DO NOT SCALE DRAWINGS. CONTACT THE STRUCTURAL ENGINEER FOR ANY DIMENSIONS NOT SHOWN.
10. THESE DRAWINGS ARE NOT COMPLETE UNTIL REVIEWED AND ACCEPTED BY THE LOCAL BUILDING OFFICIAL AND SIGNED BY THE OWNER AND THE STRUCTURAL ENGINEER.
11. ALL DRAWINGS AND WRITTEN MATERIAL APPEARING HEREIN CONSTITUTES THE ORIGINAL AND UNPUBLISHED WORK OF THE STRUCTURAL ENGINEER AND THE SAME MAY NOT BE DUPLICATED, USED OR DISCLOSED WITHOUT WRITTEN CONSENT OF THE STRUCTURAL ENGINEER.
12. THE STRUCTURE SHOWN ON THESE DRAWINGS IS STRUCTURALLY SOUND ONLY IN ITS COMPLETED FORM. THE STABILITY OF THIS STRUCTURE DEPENDS ON THE DIAPHRAGMS AND THE BRACING MEMBERS SHOWN. THE CONTRACTOR IS TO PROVIDE FOR THE DESIGN AND CONSTRUCTION OF SHORING FOR ALL EARTH, FORMS, CONCRETE, STEEL, WOOD, AND MASONRY TO RESIST GRAVITY, EARTH, WIND, SEISMIC, AND CONSTRUCTION LOADS. SHORING SHALL REMAIN IN PLACE UNTIL ALL DIAPHRAGMS AND LATERAL RESISTING ELEMENTS ARE IN PLACE IN THEIR ENTIRETY.

WOOD:

1. ALL SAWN LUMBER SHALL BE DOUGLAS FIR-LARCH AS GRADED BY THE WEST COAST LUMBER INSPECTION BUREAU (WCLIB) IN ACCORDANCE WITH STANDARD GRADING RULES NO. 17 TYPICAL UNLESS NOTED OTHERWISE. ALL MEMBERS SHALL HAVE A MINIMUM GRADE OF NO. 1 EXCEPT 2x4 AND 2x6 WALL STUDS, PLATES, AND BLOCKING MAY BE NO. 2.
2. MANUFACTURED LUMBER MINIMUM PROPERTIES:
 - 2.1 PARALLEL STRAND LUMBER SHALL BE GRADE 2.0E (Fb=2,900 PSI MIN) AND EQUIVALENT TO WEYERHAEUSER PARALLAM® PRODUCT.
 - 2.2 LAMINATED VENEER LUMBER SHALL BE GRADE 1.9E (Fb=2,600 PSI MIN) AND EQUIVALENT TO WEYERHAEUSER MICROLLAM® PRODUCT.
 - 2.3 GLU-LAMINATED MEMBERS-SEE "GLU-LAMINATED BEAM NOTES".
3. ALL STRUCTURAL SHEATHING USED FOR SHEARWALLS AND ROOF SHEATHING SHALL BE MANUFACTURED IN ACCORDANCE WITH PRODUCT STANDARDS OF APA - THE ENGINEERED WOOD ASSOCIATION. SHEATHING SHALL MEET PS2-04 PERFORMANCE STANDARD FOR WOOD-BASED STRUCTURAL-USE PANELS AND SHALL BE STAMPED WITH APA TRADEMARK.
4. ALL FOUNDATION PLATES OR SILLS ON CONCRETE SLABS WHICH ARE IN DIRECT CONTACT WITH EARTH, AND PLATES OR SILLS ON CONCRETE OR MASONRY FOUNDATIONS, SHALL BE PRESSURE TREATED.
5. ALL WOOD SHALL HAVE A MOISTURE CONTENT OF NOT MORE THAN 19% WHEN SHEATHING IS APPLIED.
6. 8" MINIMUM CLEARANCE SHALL BE MAINTAINED AT ALL EXTERIOR WALLS BETWEEN FINISH GRADE AND BOTTOM OF WOOD WALLS.
7. BEARING AND SHEARWALLS SHALL HAVE DOUBLE TOP PLATES LAPPED AT WALL CORNERS AND INTERSECTIONS AND PLATES SHALL BE INTERNAILED WITH (3) 16d AT SUCH LOCATIONS. FOR PLATE SPLICE DETAILS, SEE DRAWINGS.
8. SILL PLATE ANCHOR BOLTS SHALL BE INSTALLED WITH PLATE WASHERS 3x3x¼ BETWEEN NUT AND PLATE.
9. PROVIDE SOLID BLOCKING BETWEEN JOISTS AND RAFTERS AT ALL SUPPORTS.
10. PROVIDE BLOCKING AT ALL CEILING LEVELS.
11. JOISTS UNDER AND PARALLEL TO PARTITIONS SHALL BE DOUBLED AND NAILED TOGETHER.
12. HOLES FOR BOLTS IN WOOD SHALL BE BORED WITH A BIT OF THE SAME NOMINAL DIAMETER AS THE BOLT PLUS ¼"
13. HOLES FOR LAG SCREWS SHALL BE BORED AS FOLLOWS:
 - 13.1 THE CLEARANCE HOLE FOR THE SHANK SHALL HAVE THE SAME DIAMETER AS THE SHANK, AND THE SAME DEPTH OF PENETRATION AS THE LENGTH OF UNTHREADED SHANK.
 - 13.2 THE LEAD HOLE FOR THE THREADED PORTION SHALL HAVE A DIAMETER EQUAL TO 60% TO 75% OF THE SHANK DIAMETER AND A LENGTH EQUAL TO AT LEAST THE LENGTH OF THE THREADED PORTION.
14. LAG SCREWS AND WOOD SCREWS SHALL BE SCREWED AND NOT DRIVEN INTO PLACE. SOAP MAY BE USED TO LUBRICATE THE SCREWS.
15. ALL BOLTS AND LAG SCREWS SHALL BE PROVIDED WITH METAL WASHERS UNDER HEADS AND NUTS WHICH BEAR ON WOOD. APPLIES ALSO TO INSERTED EXPANDING FASTENERS, RED HEAD, ETC.

BOLT DIAMETER	MI WASHER	STEEL WASHER
5/8"Ø	2 3/4"Ø x 3/8"	3" x 3 1/4"
3/4"Ø	3"Ø x 1/8"	3" x 3 1/8"
7/8"Ø	3 1/2"Ø x 1/8"	3 1/2" x 3 1/2" x 3/8"
1"Ø	4"Ø x 1/2"	3 3/4" x 3 1/4" x 3/8"
16. ALL BOLTS AND LAG SCREWS SHALL BE TIGHTENED AT INSTALLATION AND RETIGHTENED BEFORE CLOSING IN OR AT COMPLETION OF JOB.
17. LAY ALL STRUCTURAL SHEATHING ON ROOF AND FLOORS WITH FACE GRAIN PERPENDICULAR TO SUPPORT TYPICAL UNLESS NOTED OTHERWISE. USE PLY-CLIPS AT UNSUPPORTED SHEATHING EDGES.
18. CONNECTOR HARDWARE MODEL NUMBER ARE THOSE FOR SIMPSON STRONG-TIE COMPANY. ALL JOIST HANGERS SHALL BE SIMPSON U SERIES UNLESS NOTED OTHERWISE. EQUIVALENT CONNECTORS WITH ICC ACCEPTANCE MAY BE SUBMITTED FOR REVIEW AS AN ALTERNATE.
19. NOTIFY STRUCTURAL ENGINEER AFTER WALL, FLOOR, AND ROOF SHEATHING NAILING HAS BEEN COMPLETED AND A MINIMUM OF 48 HOURS PRIOR TO CONCEALING SHEATHING.
20. ALL SPLIT, TWISTED OR OTHERWISE DAMAGED MATERIAL SHALL BE REPLACED.
21. FASTENERS AND CONNECTORS IN PRESERVATIVE-TREATED WOOD ARE TO BE APPROVED SILICONE BRONZE OR COPPER, STAINLESS STEEL OR HOT-DIPPED ZINC-COATED STEEL PER CBC 2304.9.5.
22. ALL NAILS SHALL BE COMMON WIRE SIZE.

DESIGN CRITERIA:

1. CODE: 2019 CALIFORNIA BUILDING CODE (CBC)
2. DESIGN LIVE LOADS:

AREA	LIVE LOAD	REMARKS
ROOF		
FLAT TO < 4:12	L _r = 20 PSF	REDUCIBLE PER CODE
FLOOR	L = 100 PSF	REDUCIBLE PER CODE
3. WIND DESIGN PARAMETERS:

BASIC WIND SPEED (3-SEC GUST)	V= 120 MPH
RISK CATEGORY	IV
EXPOSURE CATEGORY	C
4. EARTHQUAKE DESIGN PARAMETERS:

SEISMIC IMPORTANCE FACTOR, I _e	1.5
COMPONENT IMPORTANCE FACTOR, I _p	1.5
RISK CATEGORY	IV
SITE CLASS	D
SEISMIC DESIGN CATEGORY	D
MAPPED SPECTRAL RESPONSE PARAMETERS:	
S ₁	0.69
S _{0.2}	0.30
DESIGN SPECTRAL RESPONSE PARAMETERS:	
S _{ms}	0.57
S _{m1}	0.36
PGA	0.24
SEISMIC FORCE RESISTING SYSTEM:	
SPECIAL REINFORCED MASONRY WALLS	
RESPONSE MODIFICATION COEFFICIENTS:	
R	5
SEISMIC RESPONSE COEFFICIENTS:	
C _s	0.17
BASE SHEAR, V	40 KIP
ANALYSIS PROCEDURE:	
PSEUDO STATIC	



VE SOLUTIONS
Incorporated

7777 Greenback Lane, Suite 104
Citrus Heights, CA 95610
PH. (916) 505-0519
Fax. (916) 514-9102
E-mail: bradf@vesolutions.net



Project

AMERICORPS TRAIL

Sheet Title

GENERAL NOTES

.....
The undersigned Engineer does not represent that these plans or the specifications in connection therewith are suitable, whether or not modified for any other site than the one for which they were specifically prepared. The Engineer disclaims responsibility for these plans and specifications if they are used in whole or in part at any other site.

The contractor shall verify and be responsible for all dimensions and conditions on the job and this office must be notified in writing of any variation from the dimensions and conditions shown by these drawings.

This drawing is not final or to be used for construction until signed by the Engineer and owner.

All drawings and written material appearing herein constitute the original and unpublished work of the Engineer and the same may not be duplicated, used or disclosed without written consent of the Engineer.

Engineer: BAF
Designer: DGG
Checker:

NO.	DATE	DESCRIPTION

Job No: 22091
Date: 2/23/2023

Drawing No.

S1.0

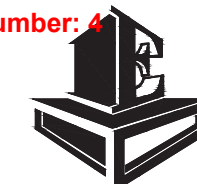

VE SOLUTIONS
 Incorporated
 7777 Greenback Lane, Suite 104
 Citrus Heights, CA 95610
 PH. (916) 505-0519
 Fax. (916) 514-9102
 E-mail: bradf@vesolutions.net



Project
AMERICORPS TRAIL

Sheet Title

BRIDGE ABUTMENT

.....
 The undersigned Engineer does not represent that these plans or the specifications in connection therewith are suitable, whether or not modified for any other site than the one for which they were specifically prepared. The Engineer disclaims responsibility for these plans and specifications if they are used in whole or in part at any other site.

The contractor shall verify and be responsible for all dimensions and conditions on the job and this office must be notified in writing of any variation from the dimensions and conditions shown by these drawings.

This drawing is not final or to be used for construction until signed by the Engineer and owner.

All drawings and written material appearing herein constitute the original and unpublished work of the Engineer and the same may not be duplicated, used or disclosed without written consent of the Engineer.

Engineer: BAF
 Designer: DGG

NO.	DATE	DESCRIPTION

Job No: 22091
 Date: 2/23/2023

Drawing No.

S2.0

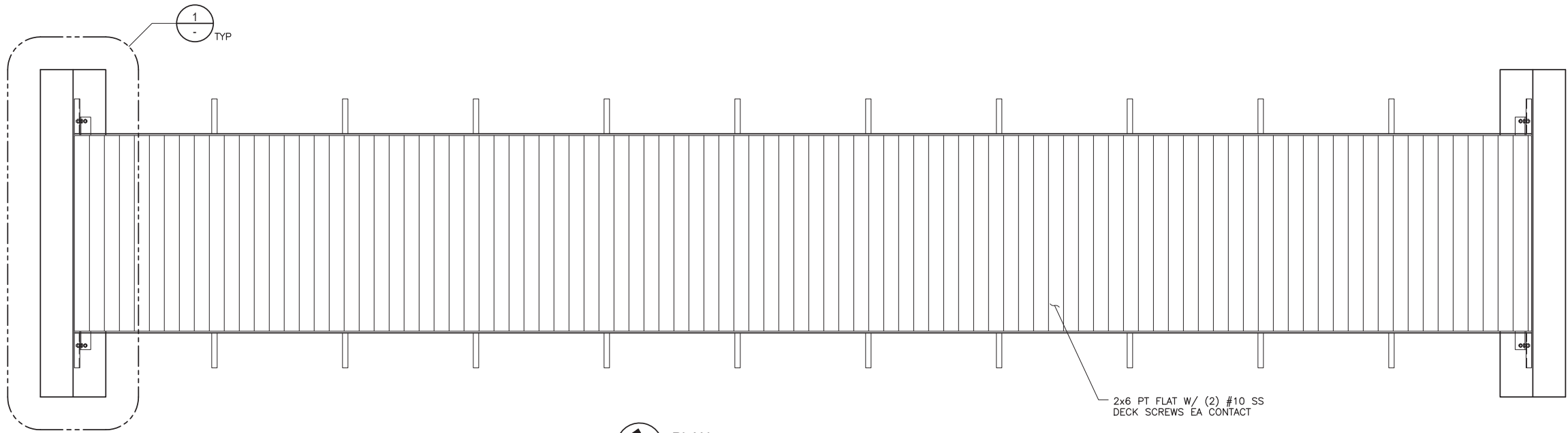

PLAN
 SCALE: 1/2"=1'-0"

2x6 PT FLAT W/ (2) #10 SS
 DECK SCREWS EA CONTACT

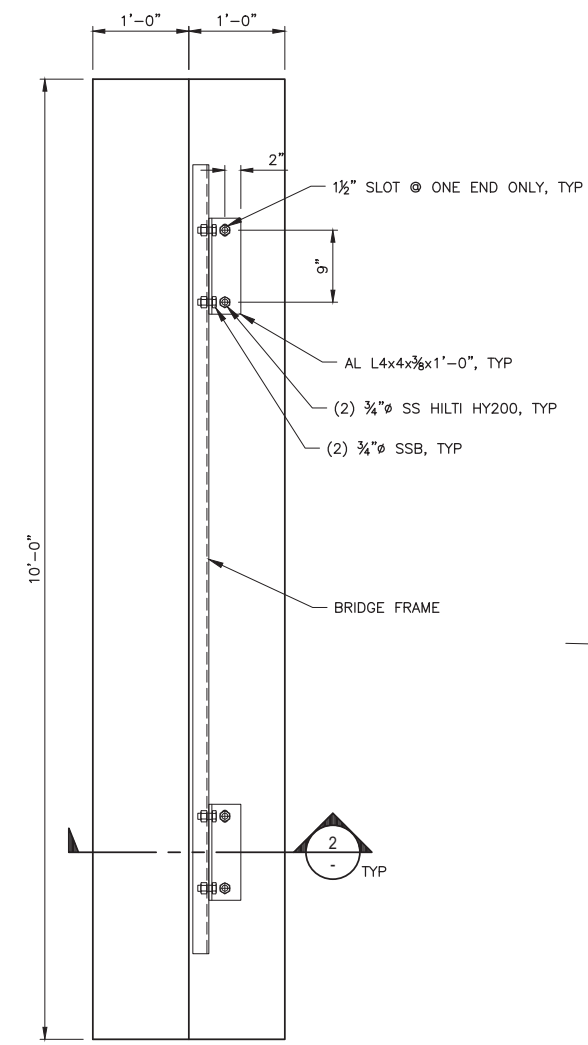

ABUTMENT PLAN
 SCALE: 1"=1'-0"

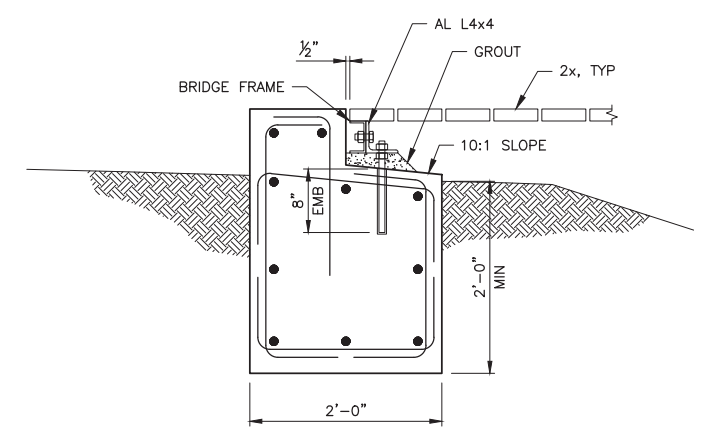

SECTION
 SCALE: 1"=1'-0"

FILE SPEC: C:\VES\22091\22091_02_Plan & Section.dwg
 PLOT DATE: Feb 23, 2023 - 6:37pm

